

**VIROQUA MUNICIPAL CODE
OF ORDINANCES**

TABLE OF CONTENTS

Title	1	General Provisions
Title	2	Administration and Personnel
Title	3	Revenue and Finance
Title	4	(Reserved)
Title	5	Business Licenses and Regulations
Title	6	Animals
Title	7	(Reserved)
Title	8	Health and Safety
Title	9	Public Peace, Morals and Welfare
Title	10	Vehicles and Traffic
Title	11	(Reserved)
Title	12	Streets and Sidewalks
Title	13	Water and Sewers
Title	14	(Reserved)
Title	15	Buildings and Construction
Title	16	Subdivisions
Title	17	Zoning

Tables

Index

TITLE 1

GENERAL PROVISIONS

Chapters:

- 1.01 Code Adoption
- 1.02 General Provisions
- 1.08 City Wards
- 1.10 Aldermanic Districts
- 1.12 General Penalty

Chapter 1.01

CODE ADOPTION

Sections:

- 1.01.010 Adoption.
- 1.01.020 Title – Citation – Reference.
- 1.01.030 Codification authority.
- 1.01.040 Ordinances passed prior to adoption of the code.
- 1.01.050 Reference applies to all amendments.
- 1.01.060 Title, chapter, and section headings.
- 1.01.070 Effect of code on past actions and obligations.
- 1.01.080 Effective date.
- 1.01.090 Constitutionality.

1.01.010 Adoption. Pursuant to the provisions of Section 66.035, Wisconsin Statutes, 1977, there is adopted the "Viroqua Municipal Code" as published by Book Publishing Company, Seattle, Washington. (Ord. 298 §1, 1978).

1.01.020 Title – Citation – Reference. This code shall be known as the "Viroqua Municipal Code" and it shall be sufficient to refer to said code as the "Viroqua Municipal Code" in any prosecution for the violation of any provision thereof or in any proceeding at law or equity. It shall be sufficient to designate any ordinance adding to, amending, correcting or repealing all or any part or portion thereof as an addition to, amendment to, correction or repeal of the Viroqua Municipal Code. Further reference may be had to the titles, chapters, sections and subsections of Viroqua Municipal Code and such references shall apply to that numbered title, chapter, section or subsection as it appears in the code. (Ord. 298 § 2, 1978).

1.01.030 Codification authority. This code consists of all the regulatory and penal ordinances and certain of the administrative ordinances of the city, codified pursuant to the provisions of Section 66.035, Wisconsin Statutes, 1977. (Ord. 298 §3, 1978).

1.01.040 Ordinances passed prior to adoption of the code. The last ordinance included in this code was Ordinance 284. The following ordinances, passed subsequent to Ordinance 284, but prior to the adoption of this code, are adopted and made a part of this code: Ordinances 285 through 297, inclusive. (Ord. 298 §4, 1978).

1.01.050 Reference applies to all amendments. Whenever a reference is made to this code as the "Viroqua municipal code" or to any portion thereof, or to any ordinances of the city, the reference shall apply to all amendments, corrections and additions heretofore, now or hereafter made. (Ord. 298 §5, 1978).

1.01.060 Title, chapter and section headings. Title, chapter and section headings contained in this code shall not be deemed to govern, limit, modify or in any manner affect the scope, meaning or intent of the provisions of any title, chapter or section of this code. (Ord. 298 §6, 1978).

1.01.070 Effect of code on past actions and obligations. Neither the adoption of this code nor the repeal or amendments of any ordinance or part or portion of any ordinance of the city shall in any manner affect the prosecution for violations of ordinances, which violations were committed prior to the effective date of this code, nor be construed as a waiver of any license, fee, or penalty, or the penal provisions applicable to any cash deposit in lieu thereof required to be posted, filed or deposited pursuant to any ordinance and all rights and obligations thereunder appertaining shall continue in full force and effect. (Ord. 298 §7, 1978).

1.01.080 Effective date. This code shall become effective on the date the ordinance adopting this code as the "Viroqua Municipal Code" becomes effective. (Ord. 298 §8, 1978).

1.01.090 Constitutionality. If any section, subsection, sentence, clause or phrase of this code is for any reason held to be invalid or unconstitutional, such decision shall not affect the validity of the remaining portions of this code. The council declares that it would have passed this code, and each section, subsection, sentence, clause or phrase thereof, irrespective of the fact that any one or more sections, subsections, sentences, clauses or phrases have been declared invalid or unconstitutional, then the original ordinance of ordinances shall be in full force and effect. (Ord. 298 §9, 1978).

Chapter 1.04

GENERAL PROVISIONS

Sections:

1.04.010	Definitions.
1.04.020	Title of Office.
1.04.030	Interpretation of language.
1.04.040	Grammatical interpretation.
1.04.050	Acts by agents.
1.04.060	Prohibited acts include causing and permitting.
1.04.070	Computation of time.
1.04.080	Construction.
1.04.090	Repeal shall not revive any ordinances.

1.040.010 Definitions. The following words and phrases, whenever used in the ordinances of the City of Viroqua, Wisconsin, shall be construed as defined in this section unless from the context a different meaning is intended or unless a different meaning is specifically defined and more particularly directed to the use of such words or phrases:

A. "City" means the City of Viroqua, Wisconsin, or the area within the territorial limits of the City of Viroqua, Wisconsin, and such territory outside of the city over which the city has jurisdiction or control by virtue of any constitutional or statutory provision.

B. "Council" means the common council of the City of Viroqua. "All its members" or "all councilmen" means the total number of councilmen holding office.

C. "County" means the County of Vernon.

D. "Law" denotes applicable federal law, the Constitution and statutes of the state of Wisconsin, the ordinances of the City of Viroqua, and, when appropriate, any and all rules and regulations which may be promulgated thereunder.

E. "May" is permissive.

F. "Month" means a calendar month.

G. "Must" and "shall" are each mandatory.

H. "Oath" includes an affirmation or declaration in all cases in which, by law, an affirmation may be substituted for an oath, and in such cases the words "swear" and "sworn" shall be equivalent to the words "affirm" and "affirmed".

I. "Owner", applied to a building or land, includes any part owner, joint owner, tenant in common, joint tenant, tenant by the entirety, of the whole or a part of such building or land.

J. "Person" includes a natural person, joint venture, joint stock company, partnership, association, club, company, corporation, business, trust or organization, or the manager lessee, agent, servant, office or employee of any of them.

- K. "Personal property" includes money, goods, chattels, things in action and evidences of debt.
- L. "Preceding" and "following" mean next before and next after, respectively.
- M. "Property" includes real and personal property.
- N. "Real property" includes lands, tenements and hereditaments.
- O. "Sidewalk" means that portion of a street between the curblin and the adjacent property line intended for the use of pedestrians.
- P. "State" means the State of Wisconsin.
- Q. "Street" includes all streets, highways, avenues, lanes, alleys, courts, places, squares, curbs or other public ways in the city which have been or may be dedicated and open to public use, or such other public property so designated in any law of the state.
- R. "Tenant" and "occupant", applied to a building or land, include any person who occupies the whole or a part of such building or land, whether alone or with others.
- S. "Written" includes printed, typewritten, mimeographed, multigraph ed, or otherwise reproduced in permanent visible form.
- T. "Year" means a calendar year. (Ord. 278 §1, 1977).

1.04.020 Title of Office. Use of the title of any officer, employee, department, board or commission means that officer, employee, department, board or commission of the City of Viroqua. (Ord. 278 §2, 1977).

1.04.030 Interpretation of language. All words and phrases shall be construed according to the common and approved usage of the language, but technical words and phrases and such others as may have acquired a peculiar and appropriate meaning in the law shall be construed and understood according to such peculiar and appropriate meaning. (Ord. 278 §3, 1977).

1.04.040 Grammatical interpretation. The following grammatical rules shall apply in the ordinances of the City of Viroqua, unless it is apparent from the context that a different construction is intended:

- A. Gender. Each gender includes the masculine, feminine and neuter genders.
- B. Singular and Plural. The singular number includes the plural and the plural includes the singular.
- C. Tenses. Words used in the present tense include the past and the future tenses and vice versa, unless manifestly inapplicable. (Ord. 278 §4, 1977).

1.04.050 Acts by agents. When an act is required by an ordinance, the same being such that it may be done as well by an agent as by the principal, such requirement shall be construed to include all such acts performed by an authorized agent. (Ord. 278 § 5, 1977).

1.04.060 Prohibited acts include causing and permitting. Whenever in the ordinances of the City of Viroqua, any act or omission is made unlawful, it shall include causing, allowing, permitting, aiding, abetting, suffering or concealing the fact of such act or omission. (Ord 278 § 6, 1977).

1.04.070 Computation of time. Except when otherwise provided, the time within which an act is required to be done shall be computed by excluding the first day and including the last day, unless the last day is Sunday or a holiday, in which case it shall also be excluded. (Ord. 278 § 7, 1977).

1.04.080 Construction. The provisions of the ordinances of the City of Viroqua and all proceedings under them are to be construed with a view to effect their objects and to promote justice. (Ord. 278 § 8, 1977).

1.04.090 Repeal shall not revive any ordinances. The repeal of an ordinance shall not repeal the repealing clause of an ordinance or revive any ordinance which has been repealed thereby. (Ord. 278 § 9, 1977).

Chapter 1.08

CITY WARDS

The City shall be divided into nine wards numbered from 1 to 9 inclusive. The boundaries and numbers of the nine wards are reflected on the official map of the City of Viroqua located in the office of the City Clerk.

[INTENTIONALLY LEFT BLANK]

[INTENTIONALLY LEFT BLANK]

[INTENTIONALLY LEFT BLANK]

Chapter 1.10

ALDERMANIC DISTRICTS

The City shall be divided into 9 Aldermanic Districts numbered from 1 to 9 inclusive. The boundaries of the Aldermanic Districts coincide with the 9 City Wards, and the Ward number is the Aldermanic District number.

Chapter 1.12

GENERAL PENALTY

Sections:

- 1.12.010 Penalty where no penalty provided.
- 1.12.020 Penalty for nonpayment of fine.
- 1.12.030 Statutory penalties adopted where required.

1.12.010 Penalty where no penalty provided.

A. In any case where there is a violation of any ordinance for which no penalty is provided, the person violating the same shall be subject to a forfeiture of not less than ten dollars nor more than two hundred dollars for each offense, except as follows: in any case where any ordinance or section of an ordinance of the City does not provide the greater penalty for a second or subsequent conviction for a violation thereof, any person violating the same who has previously been convicted of a violation thereof shall be subject to a forfeiture of not less than twenty-five dollars nor more than two hundred dollars for each offense, except that where the penalty provided by any such ordinance or section for a first violation thereof is larger than the penalty provided in this subsection, such larger penalty shall be applicable.

B. No violation of any ordinance of the City shall be or be construed to be a misdemeanor, nor shall imprisonment be imposed as a punishment for violation of any ordinance of the City. (Ord. 279 §1, 1977).

1.12.020 Penalty for nonpayment of fine. In the event of a failure to pay a judgment assessed, where no showing of indigency is made, the defendant may be imprisoned for no more than ninety days, as the court deems fit, or until such judgment is sooner paid. (Ord. 279 §2, 1977).

1.12.030 Statutory penalties adopted where required. Where a statute requires that the penalty under any municipal ordinance shall conform to the penalty provided by statute, the statutory penalty, as the same is in effect at the time of the violation of the ordinance of the City, is adopted as the penalty for violation of such ordinance. (Ord. 279 §3, 1977).

Title 2

ADMINISTRATION AND PERSONNEL

Chapters:

<u>2.04</u>	<u>City Clerk-Treasurer; Deputy</u>
<u>2.06</u>	<u>Municipal Court</u>
<u>2.08</u>	<u>City Assessor</u>
<u>2.09</u>	<u>City Administrator</u>
<u>2.10</u>	<u>City Attorney</u>
<u>2.11</u>	<u>Regular Police Department</u>
<u>2.12</u>	<u>Reserve Police Officers</u>
<u>2.16</u>	<u>Volunteer Fire Department</u>
<u>2.18</u>	<u>Police and Fire Commission</u>
<u>2.20</u>	<u>Board of Park Commissioners</u>
<u>2.24</u>	<u>Board of Review</u>
<u>2.26</u>	<u>Comprehensive Planning Commission</u>
<u>2.28</u>	<u>Plan Commission</u>
<u>2.29</u>	<u>Outdoor Aquatic Facility Advisory Committee</u>
<u>2.30</u>	<u>Health Officer</u>
<u>2.32</u>	<u>Officers' Salaries</u>
<u>2.36</u>	<u>Elections</u>
<u>2.38</u>	<u>Airport Commission</u>
<u>2.39</u>	<u>Viroqua Municipal Golf Utility</u>
<u>2.40</u>	<u>Emergency Government</u>
<u>2.42</u>	<u>Records Maintenance and Access</u>
<u>2.44</u>	<u>Veterans Memorial Commission</u>
<u>2.46</u>	<u>Toys for Tots Commission</u>
<u>2.48</u>	<u>Tourism Commission</u>
<u>2.50</u>	<u>Housing Advisory Board</u>

Chapter 2.04

CITY CLERK-TREASURER; DEPUTY

Sections:

- 2.04.010 Combination of offices.
- 2.04.020 Appointment - term of office.
- 2.04.030 Deputy.
- 2.04.040 City obligated for taxes.

2.04.010 Combination of offices of Clerk and Treasurer. The offices of Clerk and Treasurer are combined into one office, that of Clerk-Treasurer.

2.04.020 Appointment - Term of office. The City Clerk-Treasurer shall be appointed by the Common Council, and shall hold office for an indefinite term.

2.04.030 Deputy. A deputy Clerk-Treasurer may be appointed by the Common Council, and shall hold office for an indefinite term.

2.04.040 City Obligated for taxes. The City of Viroqua is obligated to pay, in case the treasurer shall fail so to do, all taxes of any kind required by law to be paid by such treasurer, pursuant to the provisions of section 70.67 (2), Wisconsin Statutes.
(Ord. 426, 1990; Ord 05OR009)

Chapter 2.06MUNICIPAL COURTSections:

2.06.010	Municipal Court created
2.06.020	Municipal Judge
2.06.030	Elections
2.06.040	Jurisdiction
2.06.050	Municipal Court hours, clerks
2.06.060	Collection of forfeitures and costs
2.06.070	Contempt of Court
2.06.080	Abolition; Withdrawal
2.06.090	Municipal Court committee
2.06.100	Inconsistent ordinances repealed
2.06.110	Effective upon publication or posting

Section 2.06.010 Municipal Court Created

Pursuant to section 66.0301 and the authority granted by Chapter 755 of the Wisconsin Statutes, there is hereby created and established a Joint Municipal Court to be designated "Municipal Court for the City of Viroqua, the City of Westby, the Village of La Farge, and the Village of Cashton", said court to become operative and function on July 1, 2005. (Ord. 05OR001)(Ord. 16OR004)

Section 2.06.020 Municipal Judge

(a) Qualifications: The Joint Court shall be under the jurisdiction of and presided over by a Municipal Judge, who shall be an attorney licensed to practice law in Wisconsin, and who resides in one of the municipalities that is a party to the agreement forming this joint court.

(b) Oath and Bond: The Judge shall, after election or appointment to fill a vacancy, take and file the official oath as prescribed in §757.02(1), Wis. Stats., and at the same time execute and file an official bond in the amount of \$1,000.00. The Judge shall not act until the oath and bond have been filed as required by §19.01(4)(c) Wis. Stats., and the requirements of §755.03(2) have been complied with.

(c) Salary: The salary of the Municipal Judge shall be fixed by the Common Council or Village Board of the municipalities that are parties to the agreement which shall be in lieu of fees and costs. No salary shall be paid for any time during the term during which such Judge has not executed the official bond or official oath, as required by §755.03, Wis. Stats., and filed pursuant to §19.01(4) (c) Wis. Stats. The municipalities may by separate ordinance allocate funds for the administration of the Municipal Court pursuant to §66.0301 Wis. Stats. (Ord. 05OR001)

Section 2.06.030 Elections

(a) Term: The Municipal Judge shall be elected at large in the spring election in even-numbered years for a term of 4 years commencing on May 1. All candidates for the position of Municipal Judge shall be nominated by nomination papers as provided in §8.10, Wis. Stats., and selection at a primary election if such is held as provided in §8.11, Wis. Stats. The Vernon County Clerk shall serve as filing officer for the candidates. (Ord. 12OR006).

(b) Electors: Electors in the City of Viroqua, the City of Westby, the Village of La Farge, and the Village of Cashton shall vote for judge.

Section 2.06.040 Jurisdiction

(a) The Municipal Court shall have jurisdiction over incidents occurring on or after the date of establishment of the Court, as provided in Article VII, §14 of the Wisconsin Constitution, §§755.045 and 755.05, Wis. Stats., and as otherwise provided by State Law. In addition, it shall have exclusive jurisdiction over actions in the municipalities that are parties to the agreement seeking to impose forfeitures for violations of municipal ordinances, resolutions and by-laws.

(b) The Municipal Judge may issue civil warrants to enforce matters under the jurisdiction of the Municipal Court under §755.045(2), and may issue special inspection warrants under §66.0119, Wis. Stats.

(c) The Municipal Court has jurisdiction over juvenile offenders when a municipality that is party to the agreement enacts an ordinance under the authority of §938.17(2)(cm), Wis. Stats. (Ord. 05OR001)

(d) The Municipal Court is authorized to impose alternative juvenile dispositions and sanctions:

1. For a juvenile adjudged to have violated an ordinance, the municipal court is authorized to impose any of the dispositions listed in sections 938.343 and 938.344, Wisconsin Statutes, in accordance with the provisions of those statutes. (Ord. 05OR010)

2. For a juvenile adjudged to have violated an ordinance who violates a condition of a dispositional order of the court under sections 938.343 or 938.344, Wisconsin Statutes, the municipal court is authorized to impose any of the sanctions listed in section 938.355(6)(d), Wisconsin Statutes, in accordance with the provisions of those statutes. (Ord. 05OR010)

3. This section is enacted under the authority of section 938.17(2)(cm), Wisconsin Statutes (Ord 05OR010).

Section 2.06.050 Municipal Court hours, clerks (a) Hours: The Municipal court shall be open at such location and at such times as determined by the governing bodies of the municipalities that are parties to the agreement and the Municipal Judge.

(b) Employees: The Judge shall, in writing, appoint such clerks and deputy clerks as are authorized and funded by the City of Viroqua, the City of Westby, the Village of La Farge, and the Village of Cashton. (Ord. 05OR001)(Ord. 16OR004)

Section 2.06.060 Collection of Forfeitures and Costs (a) The Municipal Judge may impose punishment and sentences as provided by Chapters 800 and 938 Wis. Stats., and as provided in the ordinances of the municipalities that are parties to the agreement. All forfeitures, fees, assessments, surcharges and costs shall be paid to the treasurer of the Municipality within which the case arose within 7 days after receipt of the money by the Municipal Court. At the time of the payment, the Municipal Court shall report to the treasurer the title of the action, the nature of the offenses and total amount of judgments imposed in actions and proceedings in which such monies were collected. (Ord. 05OR001)

(b) When City police or other City authorized personnel serve any process, including warrants, the fee to be collected from the defendant shall be \$20 for such service, as authorized by sections 814.70 and 814.705 of the Wisconsin Statutes. (Ord. 06OR004)

Section 2.06.070 Contempt of Court

The Municipal Judge, after affording an opportunity to the person accused to be heard in defense, may impose a sanction authorized under §800.12 Wis. Stats. and may impose a forfeiture therefore not to exceed fifty dollars (\$50) or upon nonpayment of the forfeiture and the assessments thereon, a jail sentence not to exceed seven (7) days. (Ord. 05OR001)

Section 2.06.080 Abolition; Withdrawal (a) The Municipal court hereby established shall not be abolished while the agreement between the City of Viroqua, the City of Westby, the Village of La Farge, and the Village of Cashton, is in effect. (Ord. 16OR004)

(b) The City may withdraw from the agreement by giving notice, in writing, to the municipal court committee no later than September 30th of any year. Upon giving such notice, the City's participation in the joint municipal court shall terminate on December 31st of said year. (Ord. 05OR001)

Section 2.06.090 Municipal Court Committee

(a) ORGANIZATION. Except for matters required by statute to be determined by the respective governing bodies or member municipalities, the general operation of the court shall be by the judge and the Municipal Court Committee.

(b) MUNICIPAL COURT COMMITTEE.

(i) Composition and terms. The Municipal Court Committee shall be comprised of one representative of each member municipality who shall be appointed by the City Mayors and the Village Board Presidents, subject to confirmation by the respective governing body, and in addition, one member who shall be a police chief of a member municipality. The initial member Chief shall be the Chief of Police of Viroqua. The Chief's position shall be replaced on a yearly basis by means of rotation among the chiefs. Chiefs will rotate as follows: after the initial term of the Viroqua Chief of Police, the Westby Chief of Police, then the La Farge Chief of Police, then the Cashton Chief of Police. In order to assure participation and continuity of representation, each member municipality may appoint an alternate representative who shall act on committee matters in the absence of the representative, and the Chief of Police may appoint an alternate. In order to ensure continuity on the Municipal Court Committee, the initial terms for the representatives other than Police Chief shall be as follows: the initial term of the representative from the Village of Cashton shall be four (4) years, the initial term of the representative from the Village of La Farge shall be three (3) years, the initial term of the representative from the City of Westby shall be two (2) years, and the initial term of the representative from the City of Viroqua shall be one (1) year. Thereafter, the term for the representatives other than Police Chief shall be two (2) years.

(16OR004)

(ii) Powers and Duties. The Municipal Court Committee shall have general control over the operation of the court, except where such control is specifically granted to the judge or the governing bodies by statute, in which case the Municipal Court Committee shall be a recommending body to the judge or governing bodies. The Municipal Court Committee shall make recommendations to the City of Viroqua for the position of clerk of court as well as other court employees. The Municipal Court Committee shall recommend to the governing bodies of the member municipalities for determination, the salary of the judge, the number and salary of such clerks and/or deputy clerks. The City of Viroqua shall cause appropriate accounts to be established for the deposit of all fees, forfeitures, assessments and costs paid into the court and shall adopt appropriate accounting procedures to ensure proper handling of said funds.

(iii) The Municipal Court shall, with the assistance of the judge and court clerk, prepare an annual budget for the operation of the court. The budget shall be for a calendar year, i.e., January 1 through December 31. The Municipal Court Committee shall cause an annual audit of court accounts to be completed no later than June 30th of each year.

(iv) The Municipal Court Committee may establish any subcommittees necessary for the efficient operation of the court, such as a personnel committee and/or operating sub-committee.

(v) Voting and Procedure. The Municipal Court Committee shall be governed by Roberts Rule of Order and a majority vote of all representatives of the Municipal Court Committee shall be required to adopt any motion or resolution. Three (3) members or alternate members shall constitute a quorum.

(c) BUDGET; EXPENDITURES.

(i) Time and Approval. The Municipal Court Committee and court clerk shall, with the assistance of the judge, formulate a budget annually, no later than September 1st of each year for the next succeeding year. The members of the committee shall present said budget to their respective governing bodies for approval. The budget shall be approved annually by the governing bodies no later than November 1st. Approval by a majority of the member municipalities shall constitute approval of the budget.

(ii) Court costs. One hundred percent (100%) of the local share of the court costs required to be collected pursuant to Section 814.65(1) Wis. Stats., shall be retained by the court to be applied to the operating expenses of the court.

(iii) Court Operating Expenses. Any net operating expenses after application of the local share of the court costs shall be charged to member municipalities based upon each municipality's percentage of the total annual filed cases, and any net income shall likewise be distributed to the member municipalities based upon each municipality's percentage of the total annual filed cases. The charge or credit to each municipal member shall be based upon the approved budget, and the net income or loss shall be credited or charged to the respective member municipalities with thirty (30) days after completion of the annual audit.

(iv) Initial Court Operating Expenses. Prior to the initial commencement of the joint municipal court, the Municipal Court Committee and court clerk, with the assistance of the municipal judge, shall adopt a budget for said court for the period beginning on the date of commencement and ending on the first December 31st following said commencement. Each member municipality shall pay an initial charge for court operating expenses for said period of time. Said charge shall be on a pro rata basis based upon the average of the last two years' number of cases for each member municipality based on the circuit court records of Vernon County for the member municipalities. In addition, the cost of any initial equipment and the initial supplies necessary to begin operations shall be so apportioned between the member municipalities. Forms shall be considered as supplies for purposes of this paragraph. (Ord. 05OR001)

Section 2.06.100 Inconsistent ordinances repealed

All ordinances or parts of ordinances contravening or inconsistent with the provisions of this ordinance be and are hereby repealed. (Ord. 05OR001)

Section 2.06.110 Effective upon publication or posting

This ordinance shall take effect and be in full force and effect from and after its passage by the municipalities that are parties to the agreement and publication or posting as required by law. (Ord. 05OR001)

Chapter 2.08

CITY ASSESSOR

Sections:

- 2.08.010 Appointment – Term of office.
- 2.08.020 Appointment - Qualification.

2.08.010 Appointment – Term of Office. The City assessor shall be appointed by the Common Council, and shall hold office for an indefinite term.

2.08.020 Appointment – Qualification. No person may assume the office of city assessor unless certified by the Department of Revenue as qualified to perform the functions of the office of assessor. (Ord. 329, § 1, 1982; 05OR009)

Chapter 2.09

CITY ADMINISTRATOR

Sections:

- 2.09.010 Office of the City Administrator.
- 2.09.020 Appointment.
- 2.09.040 Functions and Duties of the Administrator.
- 2.09.050 Cooperation.

2.09.010 Office of the City Administrator. In order to provide the City of Viroqua with a more efficient, effective and responsible government under a system of a part-time mayor and part-time common council (hereinafter referred to as "council") at a time when city government is becoming increasingly complex, there is hereby created the Office of City Administrator for the City of Viroqua (hereinafter referred to as "administrator"). (Ord. 538, 2003)

2.09.020 Appointment. The administrator shall be appointed on the basis of merit with due regard to training, experience, administrative ability and general fitness for the office, by a majority vote of the council.

2.09.040 Functions and Duties of the Administrator. The administrator, subject to the limitations defined in resolutions and ordinances of the City of Viroqua and Wisconsin State Statutes, shall be the chief administrative officer of the city, responsible only to the mayor and the council for the proper administration of the business affairs of the city, pursuant to the statutes of the State of Wisconsin, the ordinances of the City of Viroqua, and the resolutions and directives of the council, with power and duties as follows:

(A) GENERAL DUTIES

1. Carry out directives of the mayor and council, which require administrative implementation, reporting promptly to the mayor and council any difficulties encountered herein;

2. Be responsible for the administration of all day -to-day operations of the city government including the monitoring of all city ordinances, resolutions, council meeting minutes and state statutes;

3. Prepare a plan of administration, including an organization chart, which defines authority and responsibility for all nonstatutory positions of the city, and submit it to the city council for adoption as the official organization and administration procedure plan for the city;

4. Establish when necessary administrative procedures to increase the effectiveness and efficiency of city government according to current practices in local government, not inconsistent with paragraph 3 above or directives of the mayor and council;

5. Serve as ex -officio nonvoting member of all boards, commissions and committees of the city, except as specified by the council or Wisconsin State Statutes;

6. Keep informed concerning current federal, state, and county legislation and administrative rules affecting the city and submit appropriate reports and recommendations thereon to the council;

7. Keep informed concerning the availability of federal, state and county funds for local programs. Assist department heads and the council in obtaining these funds under the direction of the mayor and the council;

8. Represent the city in matters involving legislative and inter -governmental affairs as authorized and directed as to that representation by the mayor and council;

9. Act as public information officer for the city with the responsibility of assuring that the news media are kept informed about the operations of the city and that all open meeting rules and regulations are followed;

10. Establish and maintain procedures to facilitate communications between citizens and city government to assure that complaints, grievances, recommendations and other matters receive prompt attention by the responsible official, and to assure that all such matters are expeditiously resolved;

11. Promote the economic well -being and growth of the city through public and private sector cooperation;

(B) RESPONSIBILITIES TO THE CITY COUNCIL

1. Attend all meeting of the council, assisting the mayor and the council as required in the performance of their duties;

2. In coordination with the mayor, the council, and the clerk, ensure that appropriate agendas are prepared to all meetings of the council, all council committees, and all other appropriate committees and commissions of the city, together with such supporting material as may be required; with nothing herein being construed as to give the administrator authority to limit or in any way prevent matters from being considered by the council, or any of its committees and commissions;

3. Assist in the preparation of ordinances and resolutions as requested by the mayor or the council, or as needed;

4. Keep the mayor and council regularly informed about the activities of the administrator's office by oral or written report at regular and special meetings of the council;

5. In the event that action normally requiring council approval is necessary at a time when the council cannot meet, the administrator shall receive directives from the mayor.

(C) PERSONNEL

1. Be responsible for the administrative direction and coordination of all employees of the city according to the established organization procedures;

2. Recommend to the council the appointment, promotion, and when necessary for the good of the city, the suspension or termination of department heads;

3. In consultation with the appropriate department head and the appropriate committee, be responsible for the appointment, promotion, and when necessary for the good of the city, the suspension or termination of employees below the department head level; (Ord 100R002)

4. Serve as personnel officer for the city with responsibilities to see that complete and current personnel records, including specific job descriptions for all city employees are kept; evaluate in conjunction with department heads the performance of all employees on a regular basis; recommend salary and wage scales for city employees not covered by collective bargaining agreements; develop and enforce high standards of performance by city employees; assure that city employees have proper working conditions; work closely with department heads to promptly resolve personnel problems or grievances;

5. Assist in labor contract negotiations and collective bargaining issues;

6. Work closely with department heads to assure that employees receive adequate opportunities for training to maintain and improve their job-related knowledge and skills and act as the approving authority for requests by employees to attend conferences, meetings, training schools, etc., provided that funds have been budgeted for these activities.

(D) BUDGETING AND PURCHASING

1. Be responsible for the preparation of the annual city budget, in accordance with guidelines as may be provided by the city council and in coordination with department heads, and pursuant to state statutes, for review and approval by the mayor and the council;

2. Administer the budget as adopted by the council;

3. Report regularly to the council on the current fiscal position of the city;

4. Supervise the accounting system of the city and insure that the system employs methods in accordance with current professional accounting practices;

5. Serve as the purchasing agent for the city, supervising all purchasing and contracting for supplies and services, subject to the purchasing procedures established by the council and any limitation contained in the Wisconsin Statutes.

2.09.050 Cooperation. All officials and employees of the city shall cooperate with and assist the administrator so that the city government shall function effectively and efficiently.

Chapter 2.10

CITY ATTORNEY

Sections:

- 2.10.010 Selection procedure.
- 2.10.020 Amends general charter.

2.10.010 Selection procedure. The method of selection of the City Attorney is changed, from election by the voters, to appointment by the mayor, subject to confirmation by the Council. (Ord 287, § 1, 1977)

2.10.020 Amends general charter. The ordinance codified in this chapter is a charter ordinance, amending the general charter of the City, contained in Section 62.09, Wisconsin Statutes, 1975. (Ord. 287, § 2, 1977).

Chapter 2.11

REGULAR POLICE DEPARTMENT

Sections:

- 2.11.010 Governing body.
- 2.11.020 Composition.
- 2.11.030 Administration.

2.11.010 Governing Body. The regular police department shall be governed by the mayor, common council, and a committee of three or more common council members called a police and fire committee. (Ord. 348 (part), 1983).

2.11.020 Composition. The regular police department shall consist of a chief of police, second -in-command, full -time and part -time regular police officers. (Ord. 348 (part), 1983).

2.11.030 Administration.

A. The mayor shall appoint the chief of police. The chief shall hold office during good behavior subject to suspension or removal by the mayor.

B. The chief of police shall appoint a second -in-command subject to the approval of the mayor. The second -in-command shall act as chief in the absence or inability of the chief of police to perform his duties.

C. It shall be the duty of the chief of police to establish written policy manual for his department. This manual shall be reviewed and approved annually by the common council. (Ord. 348 (part), 1983).

Chapter 2.12RESERVE POLICE OFFICERSSections:

2.12.010	Creation – Composition.
2.12.020	Emergency defined.
2.12.030	Authority designated.
2.12.040	Compensation.
2.12.050	Rules – Suspension – Call to Duty.
2.12.060	Uniform.
2.12.070	Ineligibility for pension.

2.12.010 Creation – Composition. A. It is recognized that occasions arise from time to time in the City requiring police action with which, because of its limited manpower, the regular police department is unable to cope or which places an unreasonable burden on its personnel. It is not deemed to be in the best interests of the City to employ sufficient police officers to control traffic and parking during occasional parades and other public functions, or to be available for duty during other situations of an emergency nature that may arise. To ensure that the City will be prepared for such occasions that may from time to time arise requiring more police officers that can reasonably be provided by the police department, it is determined and declared to be necessary and in the public interest to create a reserve police division of the police department comprised of reserve police officers who shall act during such emergencies under the direction and supervision of the chief of police.

B. There is created a reserve police division of the police department which shall be comprised of not less than five and not more than twenty reserve police officers who shall be appointed by the public safety committee from a list of eligible candidates to be furnished by the police committee of the common council. No person shall be considered as eligible for such appointment that, for any reason, would not be eligible for appointment as police officer for the City; this is not to mean he/she must meet the minimum police officer standards set by the Wisconsin Law Enforcement Standards Board or other entity of enforcement standards. [Ord.s 208, 288, 349; 06OR008]

2.12.020 Emergency Defined. As used in this chapter "emergency" means any occurrence, situation or event in the City requiring police action and which, in the opinion of the chief of police, shall require police manpower beyond the reasonable capabilities of the police department, including specifically, but not limited thereto by the reason of enumeration, the control of traffic and parking at public functions, riots, civil commotions, unlawful assemblages, fires and other disasters. [Ord 349; 06OR008]

2.12.030 Authority designated. Members of the reserve police division will act as such and exercise the authority of police officer only when ordered to duty by the chief of police, or the chief's designee, and while acting, shall be responsible to and under the control and supervision of the chief of police, or designee. While on duty during an emergency, reserve police officers shall be considered part-time employees of the city and shall have the same responsibilities as regular police officers, excluding the power of arrest; and shall not bear arms. [Ord 349; 06OR008]

2.12.040 Compensation. Members of the reserve police division shall be paid for their services while on duty during an emergency on an hourly basis at a rate to be established by the common council. No reserve police officers shall be entitled to compensation except for services actually rendered during an emergency and pursuant to call to duty by the chief of police. The police chief shall certify to the police committee of the council the number of hours of duty performed by each reserve police officer during an emergency and they shall be paid therefor as are other part-time employees of the city. [Ord 349; 06OR008]

2.12.050 Rules – Suspension – Call to duty. A. The public safety committee of the council and the chief of police may promulgate rules for the reserve police division.

B. The chief of police shall have the authority to suspend a reserve police officer for cause for a period not to exceed thirty days. The chief of police shall immediately report such suspension to the mayor. The mayor shall review such charges against such reserve police officer and, in the mayor's discretion, may reinstate or remove the accused, or may order suspension for a specified time. A reserve police officer shall not at any time exercise the authority of a reserve police officer or be entitled to compensation as a reserve police officer during the period of suspension.

C. In the event of a call to duty of less than the entire reserve police department, the chief of police, or the chief's designee, shall determine which members shall be called in accordance with the department rules. The chief shall further have authority to excuse a reserve police officer from duty for illness or personal hardship but, in the latter case, only if such absence will not materially interfere with the performance of duty by the reserve police department. A reserve police officer shall not be entitled to compensation during the excused absence. [Ord 349; 06OR008]

2.12.060 Uniform. The reserve police officers shall wear the same uniform as the police officers. Reserve police officers shall be provided with uniforms and necessary equipment. [Ord 349; 06OR008]

2.12.070 Ineligibility for pension. Members of the reserve police division shall not be considered participating employees under the state retirement fund. [Ord 349; 06OR008]

Chapter 2.16VOLUNTEER FIRE DEPARTMENTSections:

2.16.010	Fire defined.
2.16.020	Protection company No. 1.
2.16.030	Organization and membership.
2.16.040	Powers and duties of chief.
2.16.050	Equipment.
2.16.060	Police power of department.
2.16.070	Fire inspections.
2.16.080	Violations.
2.16.090	Township agreements.
2.16.100	Mutual aid agreements.

2.16.010 Fire defined. "Fire" means any event or emergency in which it is deemed necessary to have the fire department response regardless if there is an actual fire in progress. (Ord. 350 (part), 1983).

2.16.020 Protection company No. 1 A. The volunteer fire company organized under Chapter 213 of the Wisconsin Statutes under the title of Protection Fire Company No. 1 is disbanded pursuant to Section 213.04 of the Wisconsin Statutes. In lieu thereof the members of such fire organization are officially recognized as the fire department of the city, and duty of fire fighting and the prevention of fires in the city is delegated to such department. Its organization and internal regulation shall be governed by the provisions of this chapter and by such bylaws adopted by the department as are approved by the Common Council, except as otherwise provided by law and ordinance. (cf prior ordinance 44)

B. The Viroqua Fire Department is authorized and directed to adopt bylaws and operational procedures for the control, management and government and for the regulation of business and proceedings of the department, which bylaws, after adoption of a two-third vote of the members of the department, shall not become effective and operative until presented to and approved by the Common Council. Amendments shall be adopted in the same manner. These bylaws and procedures shall be reviewed annually and endorsed by the Common Council as per the update and review procedures.

C. The Common Council shall appropriate funds to provide for operation and for such apparatus and equipment for the use of the fire department as it may deem expedient and necessary to maintain efficiency and properly protect life and property from fire.

D. The officers and members of the fire department shall receive such compensation from the City as may from time to time be fixed by the Common Council. (Ord 350 (part), 1983).

2.16.030 Organization and Membership of the Fire Department.

A. Membership and Organization. The fire department shall consist of the following persons who shall be chosen from applications made in accordance with the rules of the Police and Fire Commission:

1. A chief;
2. A maximum of 8 officers including at least 1, but no more than 2, assistant chiefs and no more than 3 captains. There shall be no limit to the number of lieutenants except that the total number of officers on the fire department shall not exceed 8; and
3. A minimum of twenty-four regular fire fighters who live or work within a five-mile radius of the City of Viroqua. (Ord. 519, 2000; Ord. 10OR0009)

B. Vacancy in the Office of Chief. In the event of a vacancy in the office of chief:

1. A vacancy in the office of chief shall be filled by appointment by the Police and Fire Commission. The highest ranking officer shall perform the duties of chief until such vacancy has been filled.

2. The chief shall immediately assume office upon appointment by the Police and Fire Commission and shall hold office until removed by the Police and Fire Commission. (Ord. 10OR009)

2.16.030 – 2.16.040

C. Eligibility of Offices of Chief and Assistant Chief. No person shall be eligible for the office of chief or assistant chief whose entire time, both day and night, is not ordinarily spent within a two-mile radius of the City of Viroqua. Except for initial appointments, the chief and assistant chiefs shall be members of the fire department in good standing for at least five years. (Ord. 416, 1990; Ord. 350(part), 1983; Ord. 10OR0009)

D. Election of Secretary and Treasurer. Eligible voting members of the fire department shall annually elect a secretary and a treasurer from among its membership. (Ord. 519, 2000; 10OR009)

2.16.040 Powers and duties of chief.

A. The chief shall have general supervision of the department, subject to this chapter and the bylaws of the department and shall be responsible for the personnel and general efficiency of the department.

B. It shall be the duty of the chief to preside at all meetings of the department, to call special meetings, to preserve order, to decide all points of order that may arise and to enforce a rigid observance of this chapter and the bylaws.

C. It shall be the duty of the chief, or his designee, to be present at all fires, to have complete command of and entire responsibility for all fire fighting operations, to plan the control of same, to direct the action of the fire fighters when they arrive at a fire, to observe that all fire fighters do their duty, to grant leaves of absence at a fire when he may deem it proper and to see that the fire apparatus is kept in proper condition at all times.

D. The chief shall have power to demote or expel any officer or member of the department for neglect or refusal to perform his departmental duties, such demotion or expulsion shall be subject to an appeal to the common council.

E. No later than October 1st of each year, the chief shall file with the city clerk a detailed estimate of the appropriations needed for the conduct of the department during the ensuing fiscal year.

F. It shall be the duty of the chief to submit a written report to the common council not later than February 1st of each year, and at such other times as he deems desirable, relating to the condition of the various places of apparatus and appurtenances, the number of fires occurring since the previous report, the date of same and loss occasioned thereby, the number of members of the department, the total number of active members in the department and resignations and expulsions from the department. He shall also report upon the drill and training program of the department, together with other pertinent information, including

recommendations of such improvements as he deems proper and necessary for the operation of the department.

2.16.040 – 2.16.060

G. He shall enforce all fire prevention ordinances of this city and state law and regulations pertaining to fire prevention and shall keep citizens informed on fire prevention methods and on the activities of the department.

H. He shall keep a fire record of every fire to which the department was called and shall enter in such record the locality of fire, time alarm was received, cause of fire, where fire started, cause of delay (if any) in responding, method of extinguishment and equipment used, amount of insurance carried on building and contents, estimated fire loss, time fire was extinguished, names of men responding and general remarks.

I. He shall keep an inventory of all apparatus and equipment and an inventory of all hose showing dates and results of test on each length, which shall be individually identified. This inventory will also be on record with the city clerk and updated annually November 1.

J. He shall perform such other duties as are incumbent on the commanding officer of the fire department. (Ord. 350 (part) 1983).

2.16.050 Equipment. A. The chief shall have control of all apparatus used by the department and shall be responsible for its proper maintenance. Emergency repairs may be authorized by the chief.

B. No apparatus shall be used for any purpose except fire fighting within the city limits, or in training therefor, except pursuant to an agreement approved by the common council after the chief has given his recommendations on such use. With the approval of the chief such apparatus may be used for emergency purposes other than fire fighting within the city. Apparatus may also be used according to any agreements that conform to Sections 2.16.090 and/or 2.16.100. A written report of all such uses shall be made yearly to the common council.

C. No person shall willfully injure in any manner any hose, hydrant or fire apparatus belonging to the city, and no vehicle shall be driven over any unprotected hose of a fire department when laid down on any street, private driveway or other place, to be used at any fire or alarm of fire without the consent of the fire department official in command. (Ord. 350 (part), 1983).

2.16.060 Police power of department. A. The officer in command at any fire is vested with full and complete authority at fires. Any officer of the department may cause the

arrest of any person failing to give the right-of-way to the fire department in responding to a fire.

2.16.060 – 2.16.100

B. The commanding officer may prescribe certain limits in the vicinity of any fire within which no persons, excepting fire fighters and police officers and those admitted by order of any officer of the department, shall be permitted to come. The officer in charge shall have the power to cause the removal of any property whenever it shall become necessary for the preservation of such property from fire or to prevent the spreading of fire or to protect the adjoining property, and during the progress of any fire he shall have the power to order the removal or destruction of any property necessary to prevent the further spread of the fire. He shall also have the power to cause the removal of all wires or other facilities and the turning off of all electricity or other services where the same impedes the work of the department during the progress of the fire.

C. Fire Fighters may enter adjacent property. It is lawful for any fire fighters while acting under the direction of the fire chief or other officer in command to enter upon the premises adjacent to or in the vicinity of any building or other property then on fire for the purpose of extinguishing such fire and in case any person shall hinder, resist or obstruct any fire fighter in the discharge of his duty as previously provided, the person so offending shall be deemed guilty of resisting fire fighters in the discharge of their duty.

D. Duties of bystanders to assist. Every person who is present at a fire shall be subject to the orders of the fire chief or officer in command and may be required to render assistance in the fighting of the fire or in removing or guarding property. Such officer shall have the power to cause the arrest of any person or persons refusing to obey orders. (Ord. 350 (part), 1983).

2.16.070 Fire Inspections. The chief of the fire department shall hold the office of fire inspector, with the power to appoint one or more deputy fire inspectors, who shall perform the same duties and have the same powers the fire inspector. (Ord. 350 (part), 1983).

2.16.080 Violations. Any violation of any of Sections 2.16.010 through 2.16.070 shall be penalized not more than two hundred fifty dollars with full compensation for any losses to property owned by the city or the fire department. (Ord. 350 (part), 1983).

2.16.090 Township agreements. Any and all fire protection agreements with individual townships shall be entered and approved by the fire chief with the final endorsement by the mayor and common council. (Ord. 350 (part), 1983).

2.16.100 Mutual aid agreements. In the interest of providing the best fire protection possible to the city, the fire chief has the authority to enter any and all mutual agreements with surrounding fire departments. (Ord. 350 (part), 1983).

Chapter 2.18POLICE AND FIRE COMMISSIONSections:

2.18.010	Created – Appointment
2.18.020	Chief – Term
2.18.030	Subordinates
2.18.040	Disciplinary Actions – Subordinates
2.18.050	Disciplinary Actions – Chiefs
2.18.060	Dismissals – re-employment

2.18.010 Created – Appointment. There is created a board of police and fire commissioners consisting of 5 citizens, 3 of whom shall constitute a quorum. The mayor shall annually, between the last Monday of April and the first Monday of May, appoint in writing to be filed with the secretary of the board, one member for a term of 5 years. However, the initial 5 appointees shall serve terms of 1, 2, 3, 4, and 5 years, respectively. No appointment shall be made which will result in more than 3 members of the board belonging to the same political party. The board shall keep a record of its proceedings.

2.18.020 Chief – term. The board shall appoint the chief of police and the chief of the fire department, who shall hold their offices during good behavior, subject to suspension or removal by the board for cause.

2.18.030 Subordinates. A. The chief shall appoint subordinates subject to approval by the board. Such appointments shall be made by promotion when this can be done with advantage, otherwise from an eligible list provided by examination and approval by the board and kept on file with the clerk.

B. For the choosing of such list the board shall adopt, and may repeal or modify, rules calculated to secure the best service in the departments. These rules shall provide for examination of physical and educational qualifications and experience, and may provide such competitive examinations as the board shall determine, and for the classification of positions with special examination for each class. The board shall print and distribute the rules and all changes in them, at city expense.

C. The examination shall be free for all U.S. citizens over 18 and under 55 years of age, with proper limitations as to residence, health and, subject to §111.321, 111.322, and 111.335, arrest and conviction record. The examination, including

minimum training and experience requirements, shall be job -related in compliance with appropriate validation standards and shall be subject to the approval of the board and may include tests of manual skill and physical strength. All relevant experience, whether paid or unpaid, shall satisfy experience requirements. The board shall control examinations and may designate and change examiners, who may or may not be otherwise in the official service of the city, and whose compensation shall be fixed by the board and paid by the city. Veterans shall be given preference points in accordance with §230.16(7).

2.18.040 Disciplinary actions against subordinates. A. A subordinate may be suspended as hereinafter provided as a penalty. He or she may also be suspended by the commission pending the disposition of charges filed against him or her.

B. Charges may be field against a subordinate by the chief, by a member of the board, by the board as a body, or by any aggrieved person. Such charges shall be in writing and shall be filed with the president of the board. Pending disposition of such charges, the board or chief may suspend such subordinate.

C. A subordinate may be suspended for cause by the chief or the board, as a penalty. The chief shall file a report of such suspension with the commission immediately upon issuing the suspension. No hearing on such suspension shall be held unless requested by the suspended subordinate. If the subordinate suspended by the chief requests a hearing before the board, the chief shall be required to file charges with the board upon which such suspension was based.

D. Following the filing of charges in any case, a copy thereof shall be served upon the person charged. The board shall set a date for hearing not less than 10 days nor more than 30 days following service of charges. The hearing on the charges shall be public, and both the accused and the complainant may be represented by an attorney and may compel the attendance of witnesses by subpoenas which shall be issued by the president of the board on request and be served as are subpoenas under Ch. 885.

E. If the board determines that the charges are not sustained, the accused, if he has been suspended, shall be immediately reinstated and all lost pay restored. If the board determines that the charges are sustained, the accused, by order of the board, may be suspended or reduced in rank, or suspended and reduced in rank, or removed, as the good of the service may require.

F. Findings and determinations hereunder and orders of suspension, reduction, suspension and reduction, or removal, shall be in writing and, if they follow a hearing, shall be filed within 3 days thereof with the secretary of the board.

G. Further rules for the administration of this section may be made by the board.

H. No person shall be deprived of compensation while suspended pending disposition of charges.

I. Any person suspended, reduced, suspended and reduced, or removed by the board may appeal from the order of the board to the circuit court by serving written notice thereof on the secretary of the board within 10 days after the order is filed. Within 5 days thereafter the board shall certify to the clerk of the circuit court the record of the proceedings, including all documents, testimony and minutes; and the procedure of section 62.13, Wis. Stats., shall then be observed to the extent applicable thereto.

2.18.050 Disciplinary actions against chiefs. The provisions of section 2.18.040 shall apply to disciplinary actions against the chiefs where applicable. In addition thereto, the board may suspend a chief pending disposition of charges filed by the board or by the mayor of the city.

2.18.060 Dismissals and re-employment. A. When it becomes necessary, because of need of economy, lack of work or funds, or for other just causes, to reduce the number of subordinates, the emergency, special temporary, part-time, or provisional subordinates, if any, shall be dismissed first, and thereafter subordinates shall be dismissed in the order of the shortest length of service in the department.

B. When it becomes necessary for such reasons to reduce the number of subordinates in the higher positions or offices, or to abolish any higher positions or offices in the department, the subordinate or subordinates affected thereby shall be placed in a position or office in the department less responsible according to his or her efficiency and length of service in the department.

C. The name of a subordinate dismissed for any cause set forth in this section shall be left on any eligible re-employment list for a period of two years after date of dismissal. If any vacancy occurs, or if the number of subordinates is increased, in the department, such vacancy or new positions shall be filled by persons on such list in the inverse order of the dismissal of such persons.

Chapter 2.20

BOARD OF PARK COMMISSIONERS

Sections:

- 2.20.010 Established Powers and duties.
- 2.20.020 Care of trees in parks.

2.20.010 Established Powers and Duties.

A. There is established a Board of Park Commissioners, to be known and designated as such, for the City, the same to consist of five residents of the City and to consist of alderpersons appointed by the Mayor and confirmed by the Common Council. (Ord 06OR001; Ord. 468, 1996)

B. Said Board is empowered and directed to govern, manage, control, improve and care for all public parks within, or partly within and partly without, the corporate limits of the City; to secure the quiet, orderly and suitable use and enjoyment thereof by the people, including expressly to close such parks to public use, when in the judgment of the Board it is appropriate so to do; and to adopt rules and regulations to promote those purposes;. (Ord 06OR001; Ord. 513, 2000; Ord. 282 S.3, 1977; Ord. 33 S.1, 1917).

C. No person shall discharge any arrow, or throw any javelin, discuss, or shot put, in a public park.

2.20.020 Care of trees in parks.

The Board of Park Commissioners may plant, transplant, remove, trim, spray and otherwise care for and protect all trees in all public parks. See 8.36, Trees and Shrubs, for care of trees and shrubs on street boulevards and other lands belonging to the City. (Ord 06OR001)

Chapter 2.24

BOARD OF REVIEW

Sections:

2.24.010 Created - Appointment.

2.24.020 Compensation.

2.24.010 Created - Appointment.

A. There is created and established a Board of Review, as provided for by Section 70.46 of the Wisconsin Statutes, which shall consist of five residents of the City, none of whom shall occupy any public office or be publicly employed.

B. Said members shall be appointed by the Mayor of the City with the approval of the Common Council and shall hold office as members of said Board for five years and until their successors are appointed and qualified. (Ord. 129 §2, 1948).

2.24.020 Compensation.

The members of the Board of Review shall be compensated at the rate of five dollars per day each for days actually spent in attendance at its required meetings. (Ord. 129 §3, 1948).

Chapter 2.26

COMPREHENSIVE PLANNING COMMISSION

Sections:

- 2.26.010 Purpose.
- 2.26.020 Composition.
- 2.26.030 Members and alternates, how chosen.
- 2.26.040 Meeting times.
- 2.26.050 Reports to the City Council.
- 2.26.060 Attendance Standard.
- 2.26.070 Duties and Responsibilities.
- 2.26.080 Duration, termination of the commission.

2.26.010 Purpose of Commission. The commission is created to draft a Comprehensive Plan for the City of Viroqua in accordance with section 66.1001 of the Wisconsin Statutes.

2.26.020 Composition. The commission shall consist of 4 citizen members and 1 Common Council member, all of whom may vote. 1 additional citizen member shall be selected as an alternate, and may vote in the absence of one of the regular members.

The Mayor or his/her representative, City Administrator (if the post is created) and 1 member of the City Plan Board, selected by that body, shall serve as ex officio non-voting members of the commission.

The commission shall elect a chair and a vice chair. The City shall provide a secretary to take minutes and keep records for the commission, if the commission so chooses.

Commission members shall serve without compensation.

2.26.030 Members and alternates, how chosen. A. Citizen members shall be City residents and shall not be employed by the City or be elected officials of the City. Citizen members shall not concurrently serve on more than one other City committee, board or commission. Members shall have a proven interest in or special knowledge of zoning, planning, or the smart growth principles outlined in the Comprehensive Planning law. They shall be reliable, cooperative and shall possess an ability to work in a board environment. No more than 2 voting members shall have previously served on the ad hoc "Smart Growth" committee that met in March-July 2001.

B. Commission members shall be selected by the Mayor and two Council members through an interview process. The Mayor, in consultation with the two Council members shall then recommend to the Council citizen members of the commission, for confirmation by the Council. The Common Council member shall be elected by the Council when the Commission is created and at the seating of each new Council in April the Council shall elect one of its members, or re-elect the same, to the post.

2.26.040 Meeting times. The commission shall meet at least monthly at regularly scheduled days and times, to be set by the commission. Meeting times shall be selected to best accommodate the voting membership, the non-voting membership and the public.

All meetings shall be noticed in the official City Newspaper as well as any other means in which the City normally notices City meetings, such as postings at City Hall.

2.26.050 Reports to the City Council. The Council member and the Mayor shall be the official liaison to the City Council, and shall make a report to the City Council at least quarterly on the commission's work and deliberations.

2.26.060 Attendance standard. Regular attendance at Commission meetings is deemed essential to the functioning of the commission.

Voting members and designated alternate shall attend all regular meetings of the commission. Members shall miss no more than 1 regularly scheduled meeting in a six-month period, unless excused by a majority of the commission for good cause. Inability to maintain the required attendance shall be noted in regular reports to the City Council and shall be grounds for replacement.

2.26.070 Duties and Responsibilities. The Commission shall have the following duties and responsibilities.

1. To establish written procedures to carry out the intended purposes of the Comprehensive Planning Law.

2. To select and contract, through a contract for services interview procedure, professional planning help subject to appropriation as provided for by the City Council. All contracts shall be coordinated through the City Finance Committee and City Administrator (if the post is created).

3. To prepare a Comprehensive Plan and its components. Create subcommittees from its membership to carry out the elements of a comprehensive plan.

4. To draw together data, reports, previous relevant documentation on the planning process in the City.

5. To review existing ordinances and propose necessary changes to accommodate the proposed Comprehensive Plan.

2.26.080 Duration, termination of the Commission. The commission shall exist until January 1, 2005. The City Council may extend the life of the commission in six-month increments until January 1, 2010 if it determines that the commission needs more time to finish its work. (ORD 526, 2003)

Chapter 2.28

PLAN COMMISSION

Sections:

2.28.010	Created.
2.28.020	Composition.
2.28.030	Matters of consideration - Report.
2.28.040	Recommendation of district plan and general building regulations.
2.28.050	Solicitation of advice - Map making.
2.28.060	Written records required.

2.28.010 Created. A City Plan Commission is created under the authority of Chapter 62.23 of the Wisconsin Statutes. (Ord. 144, 1951).

2.28.020 Composition.

A. The City Plan Commission shall consist of the Mayor, who shall be its presiding officer, and six (6) other members. At least three (3) members of the Commission shall be citizen members who are not city officials. Citizen members shall be persons of recognized experience and qualifications.

B. Members of the Commission shall be appointed to hold office for a period of three (3) years. Appointments shall be made by the Mayor during the month of April for terms that expire in April or at any other time if a vacancy occurs during the middle of a term.

2.28.030 Matters of consideration - Report. The Common Council shall refer to the City Plan Commission for its consideration and report before final action is taken by the Common Council, the following matters:

- A. The location and architectural design of any public building;
- B. The location of any statue or memorial;
- C. The location, acceptance, extension, alteration, vacation, abandonment, change of use, sale, acquisition of land for lease of land for any street alley, or other public way, park, playground, airport, area for parking vehicles, or other memorial or public grounds;
- D. The location, extension, abandonment or authorization for any public utility whether publicly or privately owned;
- E. All plats of lands in the City or within the territory over which the City is given platting jurisdiction by Chapter 236 of the Wisconsin Statutes;
- F. The location, character and extent or acquisition, leasing or sale of lands for public or semipublic housing, slum clearance, relief of congestion, or vacation camps for children; and
- G. The amendment or repeal of any ordinance adopted pursuant to this section.

2.28.040 Recommendation of district plan and general building regulations. The City Plan Commission shall, upon request of the Common Council, recommend a district plan and regulations governing the location of industries and of buildings designed for specific uses, the size of buildings erected after March 27, 1951, and the area of yards, courts and other open spaces. Such regulations are declared to be for public health, safety and welfare. Tentative regulations shall first be formulated and public hearings held thereon. (Ord. 144, 1951).

2.28.050 Solicitation of advice - Map making. The City Plan Commission may, if it deems it is advisable, employ expert advice upon the authority of the Plan Commission, if an appropriation is made by the Common Council therefor, and may have maps made showing proposed additions to or changes in the plan of the city. The Commission may request assistance from any municipal department, commission or agency. (Ord. 144, 1951).

2.28.060 Written records required. The Plan Commission shall keep written records of its proceedings which shall be open to inspection at all times. (Ord. 144, 1951).

Chapter 2.29

OUTDOOR AQUATIC FACILITY ADVISORY COMMITTEE

2.29.010: Committee established. There is hereby created an advisory committee to evaluate the City's need for an outdoor aquatic facility.

2.29.020: Members. The committee shall be composed of three alderpersons and twelve citizens, appointed by the mayor as approved by the Council, and the director of the Parks and Recreation department.

2.29.030: Report. The committee shall report to the Parks and Recreation committee.

2.29.040: Organization. The committee may elect one of its members as chairperson, and shall determine the time and place of its meetings.

2.29.050: Open meetings. Meetings of the committee shall be open to the public except to the extent a closed meeting is permitted or required pursuant to the provisions of section 19.85, Wisconsin Statutes.

2.29.060: Records. The Committee shall keep a record of its members, and keep minutes of the substance of its meetings, all of which shall constitute public records of the City. (ORD 540, 2003)

Chapter 2.30

HEALTH OFFICER

2.30.010 Health Officer. Pursuant to the provisions of Section 141.02, Wisconsin Statutes, the Common Council dispenses with a Board of Health, and the powers and duties of such Board of Health are vested in a health officer to be appointed by the Mayor. Such health officer shall be a physician, or in lieu thereof, a person with training and experience in public health administration meeting the training and experience requirements established by the Wisconsin Department of Health. The health officer shall provide such additional rules and regulations as are necessary for the preservation of health, to prevent the spread of communicable diseases, and to cause the removal of all objects detrimental to health and to enforce the health laws. All proposed rules and regulations shall be reported to the Council by the health officer, and if the Council approves the same by a vote of a majority of its members, such rules and regulations shall have the force and effect of ordinances, including penalty for violation. The health officer shall from time to time recommend to the Council such sanitary measures, to be executed by the City as seem necessary, and shall discharge such other duties as may be imposed upon him by the Council by ordinance or resolution. (Ord. 385, §1, 1986).

Chapter 2.32OFFICER'S SALARIESSections:

2.32.010 Officers' compensation

2.32.010 Officers' compensation. The compensation of the alderpersons and mayor who may be elected or appointed for a definite term during the ensuing year is fixed as follows:

A. Mayor, a monthly salary of Three Hundred dollars; beginning January 1, 2014, Four Hundred Fifty dollars, thereafter increased annually using the consumer price index, plus \$25.00 per meeting for each meeting the mayor attends. (12OR004)

B. Aldermen and alderwomen, a monthly salary of One Hundred Fifty dollars; beginning January 1, 2014, Two Hundred dollars, thereafter increased annually using the consumer price index, plus \$25.00 per meeting for committee members who attend a committee meeting. (12OR004)

C. President of the Council, an additional salary of ten dollars per month;

D. Chairperson of the finance committee of the Council, an additional salary of ten dollars per month.

Chapter 2.36ELECTIONSSections:

2.36.010 Term of Mayor.

2.36.020 Terms of Aldermen and Alderwomen.

2.36.030 Polls open when – Public notice.

2.36.010 Term of Mayor. The mayor shall be elected by the people at the election in April, and the term of office shall be two years. (Ord. 21, 1904).

2.36.020 Terms of Aldermen and Alderwomen. Alderpersons for wards 1, 3, 5, 7, and 9 shall be elected in odd numbered years at the spring election; alderpersons for wards 2, 4, 6, and 8 shall be elected in even numbered years at the spring election; and the term of office shall be 2 years. (Ord 495, 1999)

2.36.030 Polls open when - notification. The polls during elections shall open and close at the times required by law. Notice thereof shall be given as required by publication in the official paper.

August 2012 revision

Chapter 2.38AIRPORT COMMISSIONSections:

2.38.010	Commission established
2.38.020	Appointment of Commissioners
2.38.030	Terms
2.38.040	Qualifications, compensation
2.38.050	Officers
2.38.060	Management of Airport
2.38.070	Manager, employees
2.38.080	Authority over Airport
2.38.090	User fees - penalty

Section 2.38.010 Commission established. An Airport Commission of seven (7) Commissioners is hereby created, and jurisdiction for the construction, improvement, maintenance and operation of the Viroqua Municipal Airport is hereby vested in said commission. (Ord. 510, 2000)

Section 2.38.020 Appointment of Commissioners. Such Commissioners shall be appointed by the Mayor, subject to the approval of the Common Council.

Section 2.38.030 Terms. The term of office for said Commissioners shall be six years; on the first appointment the members shall be appointed for terms of one, two, three, four, and six years, respectively.

Section 2.38.040 Qualification, compensation. Such Commissioners shall be persons especially interested in aeronautics, and their compensation and allowance for expenses shall be fixed from time to time by the City of Viroqua.

Section 2.38.050 Officers. Such Airport Commission shall elect one member Chairman and one secretary. The secretary shall keep an accurate record of all of the proceedings and transactions of the Airport Commission and report such to the governing bodies.

Section 2.38.060 Management. Such Airport Commission shall have complete and exclusive control and management of the Viroqua Municipal Airport. All monies appropriated for the construction, improvement, equipment, maintenance or operation of said air port or earned by such airport or made available for its construction, improvement, equipment, maintenance or operation in any manner whatsoever shall be deposited with the Treasurer of the City of Viroqua where such monies shall be kept in a special fund and paid out only on order of the Airport Commission, drawn and signed by the secretary and countersigned by the chairman.

Section 2.38.070 Manager, employees. Such Airport Commission may employ and fix the compensation of a manager who shall not be a member of the Commission. Such Commission may employ and fix the compensation of such other employees as may be deemed necessary.

Section 2.38.080 Authority. Such Airport commission is expressly authorized to execute, in the name of the City of Viroqua, such contracts, leases or other agreements as they deem necessary for the construction, improvement, equipment, maintenance or operation of the airport, subject to the normal budgetary procedures of the governing body. Such Commission may contract with the United States, the State of Wisconsin, or any agency thereof; may petition, in the name of the governing body, for such state and federal aid as may be available for airport purposes, and after resolution certifying the availability of local funds, or appropriation of such funds, may execute agency agreements, contracts and all other documents necessary to the project.

Such Commission shall have the power to do all acts and things necessary or convenient for the promotion of its business and the general welfare of the Commission in order to carry out the powers, duties and responsibilities imposed by this provision or any other laws. (Ord. 424, 1990)

Section 2.38.090 User fees - penalty. Every owner of an "aircraft" (defined as any contrivance invented, used or designed for navigation of or flight in the air) based at the Viroqua Municipal Airport most of the time shall pay a user fee of \$10.00 per month, commencing the month of April, 1992, and to be due not later than the 10th of each month. For the year 1992, the amount shall be \$80 for the period April 1 through December 31 for those who paid such \$80 prior to April 1 pursuant to the rules and regulations of the Airport Commission. Beginning in the year 1993, the annual fee is discounted to \$110 if such amount is paid not later than January 10 of the year. For years after 1993, the annual fee may be set by Resolution. If the monthly fee is 90 days delinquent, the owner shall forfeit all right to keep the aircraft at the Airport, the aircraft may be removed at the expense of the owner, and the owner shall be required to forfeit, in addition to the unpaid user fee, not less than \$100 nor more than \$500, together with the costs of aircraft removal and prosecution, and in default of payment shall be imprisoned in the County jail until such user fees, forfeiture, and costs are paid, not exceeding 30 days. The amount of such judgment shall also be filed or registered with the Federal Aviation Administration in order to obtain a lien up on the title to the aircraft. (Ord 529, 2003)

Chapter 2.39

VIROQUA MUNICIPAL GOLF COURSE UTILITY

Sections:

- 2.39.010 Purpose – Creation
- 2.39.020 Management
- 2.39.030 Election of commissioners
- 2.39.040 Commissioners – Board of Directors
- 2.39.050 Officers and Government
- 2.39.060 Bonds
- 2.39.070 Construction work – public works

2.39.010 Purpose – Creation. There is hereby created and established a municipal utility of the City of Viroqua to be known as the “Viroqua Municipal Golf Course Utility”, being a public utility within the meaning of section 66.066, Wisconsin Statutes.

2.39.020 Management. The management of the utility shall be by a board of 3 nonpartisan commissioners, which board shall take entire charge and management of the utility, may appoint a manager and fix the compensation thereof, and shall supervise the operation of the utility under the general control and supervision of the Common Council of the City of Viroqua.

2.39.030 Election of Commissioners. Commissioners shall be elected by the Common Council of the City of Viroqua, take office upon election, and shall hold office for terms as provided herein. A commissioner shall serve for a term of 3 years and until the election and taking of office of a successor, provided, that the terms of the first commissioners elected shall expire as follows:

	Term expires:
Commissioner #1:	10-01-95
Commissioner #2:	10-01-96
Commissioner #3:	10-01-97

2.39.040 Commissioners – Board of Directors. A person while a member of the Board of Directors of the Viroqua Country Club, Inc., shall not be eligible to serve in the office of commissioner; the office of a commissioner while a member of the Board of Directors of the Viroqua Country Club, Inc., is vacant, and said office shall be filled by an eligible person.

2.39.050 Officers and Government. The commissioners shall choose from among their number a president and secretary. They may make rules for their own proceedings and for the government of their department. They shall keep books of account, in the manner and form prescribed by the Department of Transportation or Public Service Commission (if applicable), and which records shall be open to the public.

2.39.060 Bonds: The utility may issue bonds including revenue bonds, pursuant to the provisions of section 66.066, Wisconsin Statutes. Any obligation created by said utility shall not be an obligation of the City of Viroqua.

2.39.070 Construction – public works. Actual construction work shall be under the immediate supervision of the City of Viroqua Public Works Committee. (Ordinance #450)]

Chapter 2.40

EMERGENCY GOVERNMENT

Sections:

2.40.010 Coordination with County.

2.40.020 Appointment of Deputy.

2.40.010 Coordination with County . Pursuant to the provisions of section 66.30, Wisconsin Statutes, pertaining to intergovernmental cooperation, the City of Viroqua hereby adopts the Vernon County Emergency Operations Plan promulgated pursuant to the "Vernon County Emergency Government" ordinance. (Ord 499, 1999)

2.40.020 Appointment of Deputy. The Viroqua chief of police is hereby appointed Municipal Deputy Emergency Government Director to operate under the administration of the Vernon County Emergency Government Director. (Ord 499, 1999)

Chapter 2.42RECORDS MAINTENANCE AND ACCESSSections:

2.42.010	Definitions.
2.42.020	Duty to maintain records.
2.42.030	Legal custodian(s).
2.42.040	Public access to records.
2.42.050	Access procedures.
2.42.060	Limitations on right to access.
2.42.070	Retention of public records.

2.42.010 Definitions.

A. "Authority" means any of the following municipal entities having custody of a municipal record: an office, elected official, agency, board, commission, committee, council, department or public body corporate and politic created by constitution, law, ordinance, rule or order; or a formally constituted subunit of the foregoing.

B. "Record" means any material on which written, drawn, printed, spoken, visual or electromagnetic information is recorded or preserved, regardless of physical form or characteristics, which has been created or is being kept by an authority. "Record" includes, but is not limited to, hand-written, typed or printed pages, maps, charts, photographs, films, recording, tapes (including computer tapes), and computer printouts. "Record" does not include drafts, notes, preliminary computations and like materials prepared for the originator's personal use or prepared by the originator in the name of a person for whom the originator is working; materials which are purely the personal property of the custodian and have no relation to his or her office; materials to which access is limited by copyright, patent, or bequest; and published materials in the possession of an authority other than a public library which are available for sale, or which are available for inspection at a public library. (Ord. 340 §1(1), 1983)

2.42.020 Duty to maintain records. A. Except as provided by statute (or ordinance), each officer and employee of the municipality shall safely keep and preserve all records received from his or her predecessor or other persons and required by law to be filed, deposited or kept in his or her office or which are in the lawful possession or control of the officer or employee or his or her deputies, or to the possession or control of which he or she or they may be lawfully entitled as such officers or employees.

B. Upon the expiration of an officer's term of office or an employee's term of employment, or whenever the office or position of employment becomes vacant, each such officer or employee shall deliver to his or her successor all records then in his or her custody and the successor shall receipt therefore to the officer or employee, who shall file said receipt with the municipal clerk. If a vacancy occurs before a successor is selected or qualifies, such records shall be delivered to and receipted for by the clerk, on behalf of the successor, to be delivered to such successor upon the latter's receipt. (Ord. 340 §1(2), 1983).

2.42.030 Legal custodian(s). A. Each elected or appointed official is the legal custodian of his or her records and the records of his or her office, but the official may designate an employee of his or her staff to act as the legal custodian.

B. Unless otherwise prohibited by law, the municipal clerk or the clerk's designee shall act as the legal custodian for the Common Council and for any committees, commissions, board or other authorities created by ordinance or resolution of the municipality.

C. For every authority not specified in subsections (A) or (B), the authority's chief administrative officer is the legal custodian for the authority, but the officer may designate an employee of his or her staff to act as the legal custodian.

D. Each legal custodian shall name a person to act as legal custodian in his or her absence or the absence of his or her designee.

E. The legal custodian shall have full legal power to render decisions and to carry out the duties of an authority under subch. 11 of ch. 19, Stats., and this section. The designation of a legal custodian does not affect the powers and duties of an authority under this section. (Ord. 340 §1(3), 1983).

2.42.040 Public access to records. A. Except as provided in Section 2.42.060, any person has a right to inspect a record and to make or receive a copy of any record as provided in Section 19.35(1), Stats.

B. Records will be available for inspection and copying during all regular office hours.

C. If regular office hours are not maintained at the location where records are kept, the records will be available for inspection and copying upon at least forty-eight hours advance notice or intent to inspect or copy.

D. A requester shall be permitted to use facilities comparable to those available to municipal employees to inspect, copy or abstract a record.

E. The legal custodian may require supervision during inspection or may impose other reasonable restrictions on the manner of access to an original record if the record is irreplaceable or easily damaged.

F. A requester shall be charged a fee to defray the cost of locating and copying records as follows:

1. The cost of photocopying shall be twenty -five cents per page. Said cost has been calculated not to exceed the actual, necessary and direct cost of reproduction.

2. If the form of a written record does not permit copying, the actual and necessary cost of photographing and photographic processing shall be charged.

3. The actual full cost of providing a copy or other records not in printed form on paper, such as films, computer printouts and audio- or video-tapes, shall be charged.

4. If mailing or shipping is necessary, the actual cost thereof shall be charged.

5. There shall be no charge for locating a record unless the actual cost therefor exceeds fifty dollars, in which case the actual cost shall be determined by the legal custodian and billed to the requester.

6. The legal custodian shall estimate the cost of all applicable fees and may require a cash deposit adequate to assure payments, if such estimate exceeds five dollars.

7. Elected and appointed officials of the municipality shall not be required to pay for public records they may reasonably require for the proper performance of their official duties.

8. The legal custodian may provide copies of a record without charge or at a reduced charge where he or she determines that waiver or reduction of the fee is in the public interest.

G. Pursuant to Section 19.34, Stats., and the guidelines therein listed, each authority shall adopt, prominently display and make available for inspection and copying at its offices, for the guidance of the public, a notice containing a description of its organization and the established times and places at which, the legal custodian from whom, and the methods whereby, the public may obtain information and access to records in its custody, make requests for records, or obtain copies of records and the costs thereof.

Each authority shall also prominently display at its offices, for the guidance of the public, a copy of Sections 2.42.040 and 2.42.060. This subsection does not apply to members of the Common Council. (Ord. 340 §1(4), 1983).

2.42.050 Access procedures. A. A request to inspect or copy a record shall be made to the legal custodian. A request shall be deemed sufficient if it reasonably describes the requested record or the information requested. However, a request for a record without a reasonable limitation as to subject matter or length of time represented by the record does not constitute a sufficient request. A request may be made orally, but a request must be in writing before an action to enforce the request is commenced under Section 19.37, Stats. Except as provided below, no request may be refused because the person making the request is unwilling to be identified or to state the purpose of the request. No request may be refused because the request is received by mail, unless prepayment of a fee is required under Section 2.42.040(F)(6), requester may be required to show acceptable identification whenever the requested record is kept at a private residence or whenever security reasons or federal law or regulations so require.

B. Each custodian, upon request for any record, shall, as soon as practicable and without delay, either fill the request or notify the requester of the authority's determination to deny the request in whole or in part and the reasons therefor. If the legal custodian, after conferring with the municipal attorney, determines that a written request is so general as to be unduly time consuming, the party making the request may first be required to itemize his or her request in a manner which would permit reasonable compliance.

C. A request for a record may be denied as provided in Section 2.42.060. If a request is made orally, the request may be denied orally unless a demand for a written statement of the reasons denying the request is made by the requester within five business days of the oral denial. If a written request is denied in whole or in part, the requester shall receive a written statement of the reasons for denying the request. Every written denial of a request shall inform the requester that if the request for the record was made in writing, then the determination is subject to review upon petition for a writ of mandamus under Section 19.37(1), Stats., or upon application to the attorney general or a district attorney. (Ord. 340 §1(5), 1983).

2.42.060 Limitations on right to access. A. As provided by Section 19.36, Stats., the following records are exempt from inspection under this section:

1. Records specifically exempted from disclosure by state or federal law or authorized to be exempted from disclosure by state law;
2. Any record relating to investigative information obtained for law enforcement purposes if federal law or regulations require exemption from disclosure or if exemption from disclosure is a condition to receipt of aids by the state;

3. Computer programs, although the material used as input for a computer program or the material produced as a product of the computer program is subject to inspection; and

4. A record or any portion of a record containing information qualifying as a common law trade secret.

B. As provided by Section 43.30, Stats., public library circulation records are exempt from inspection under this section.

C. In responding to a request for inspection or copying of a record which is not specifically exempt from disclosure, the legal custodian, after conferring with the municipal attorney, may deny the request, in whole or in part, only if he or she determines that the harm to the public interest resulting from disclosure would outweigh the public interest in full access to the requested record. Examples of matters for which disclosure may be refused include, but are not limited to, the following:

1. Records obtained under official pledges of confidentiality which were necessary and given in order to obtain the information contained in them;

2. Records of current deliberations after a quasijudicial hearing;

3. Records of current deliberations concerning employment, dismissal, promotion, demotion, compensation, performance, or discipline of any municipal officer or employee, or the investigation of charges against a municipal officer or employee, unless such officer or employee consents to such disclosure;

4. Records concerning current strategy for crime detection or prevention;

5. Records of current deliberations or negotiations on the purchase of city property, investing of city funds, or other city business whenever competitive or bargaining reasons require nondisclosure;

6. Financial, medical, social or personal histories or disciplinary data of specific persons which, if disclosed, would be likely to have a substantial adverse effect upon the reputation of any person referred to in such history or data;

7. Communications between legal counsel for the city and any officer, agent or employee of the city, when advice is being rendered concerning strategy with respect to current litigation in which the city or any of its officers, agents or employees is or is likely to become involved, or communications which are privileged under Section 905.03 Stats.

D. If a record contains information that may be made public and information that may not be made public, the custodian of the record shall provide the information that may be made public and delete the information that may not be made public from the record before release. The custodian shall confer with the city attorney prior to releasing any such record and shall follow the guidance of the city attorney when separating out the exempt material. If in the judgment of the custodian and the city attorney there is no feasible way to separate the exempt material from the non-exempt material without unreasonably jeopardizing nondisclosure of the exempt material, the entire record shall be withheld from disclosure. (Ord. 340 §1(6), 1983).

2.42.070 Retention of Public Records.

A. General Records Schedule Adopted. The City of Viroqua hereby adopts, by reference, the Wisconsin Municipal Records Schedule (hereinafter "Records Schedule"), pertaining to the retention and destruction of public records and approved by the State of Wisconsin Public Records Board (hereinafter "Records Board") on August 27, 2018. A copy of the Records Schedule will be kept on file in the City Clerk's office and will be made available for public viewing during regular business hours.

B. Other Records. In the event the City of Viroqua creates a record not contemplated by the Records Schedule, the City may, subject to the Record Board's prior approval, either adopt an applicable records retention schedule set forth by the Records Board, if available, or create its own retention schedule pertaining to the record.

C. Repeal. All ordinances, or portions thereof, and resolutions, or portions thereof, in conflict with any portion of the Records Schedule are hereby repealed. Any approved City retention schedule, or portion thereof, for any record not contemplated by the Records Schedule shall remain in full force and effect.

Chapter 2.44

VETERANS MEMORIAL COMMISSION

Sections:

2.44.010	Commission Created
2.44.020	Commissioners
2.44.030	Terms of office
2.44.040	Meetings
2.44.050	Quorum
2.44.060	Uncompensated service

2.44.010 Commission created. There is created a Commission to be known as the Veterans Memorial Commission, which shall have authority and govern the Veterans Memorial conveyed to the City by the Viroqua Area Veterans Memorial, Inc., in accordance with the conveyance and the agreement made between the City and the Viroqua Area Veterans Memorial, Inc., and in accordance with the ordinances of the City.

2.44.020 Commissioners. The Commission shall be comprised of five (5) commissioners appointed by the Mayor and confirmed by the Common Council. Of those appointed, two (2) shall be veterans, two (2) shall be alderpersons at the time appointed, and one (1) shall be a member-at-large.

2.44.030 Terms of office. Commissioners shall serve for a term of three years and until a successor is appointed, except of those commissioners initially appointed two (2) shall serve for terms of one year, and three (3) shall serve for terms of three years.

2.44.040 Meetings. The Commission shall meet at least quarterly, and at such other times as called by the Mayor or the Chairperson of the Commission. At the initial meeting the Commission shall select one of the Commissioners as the Chairperson, and one of the Commissioners as the Vice Chairperson who shall serve in the absence of the Chairperson.

2.44.050 Quorum. Attendance by three (3) or more Commissioners shall constitute a quorum. A majority vote of the Commissioners present shall be necessary to approve an action of the Commission.

2.44.060 Uncompensated service. Commissioners shall not be entitled to compensation for their service. (06OR013)

Chapter 2.46

TOYS FOR TOTS COMMISSION

Sections:

- 2.46.010 Commission created
- 2.46.020 Commissioners
- 2.46.030 Officers
- 2.46.040 Uncompensated service

2.46.010 Commission created. There is created a Commission to be known as the Toys for Tots Commission, which shall have authority and govern the collection, acquisition, and distribution of toys to needy children.

2.46.020 Commissioners. The Commission shall be comprised of those individuals who volunteer and engage in any activity involved with the collection, acquisition, and distribution of toys to needy children, while so engaged.

2.46.030 Officers. The Commissioners may choose officers. A majority vote of the Commissioners present shall be necessary to approve any official action required of the Commission.

2.46.040 Uncompensated service. Commissioners shall not be entitled to compensation for their service. (07OR008)

Chapter 2.48

TOURISM COMMISSIONSections:

- 2.48.010 Created
 2.48.020 Functions and Powers

2.48.010 Created.

Pursuant to Sections 66.75(1)(a) and (1m)(c)(1), Wis. Stats., the city creates a commission to coordinate tourism promotion and development in the city. The commission, which shall be known as the "Viroqua Tourism Commission," shall consist of five members appointed by the mayor and shall be confirmed by the majority vote of all members of the common council. One of the commission members shall represent the Wisconsin lodging industry. Commission members shall serve for a one year term, at the pleasure of the mayor, and may be reappointed.

2.48.020 Functions and Powers.

(1) The Commission shall coordinate tourism promotion and tourism development for the City as set forth in Section 66.0615, Wis. Stats.

(2) The Commission shall receive room tax revenue from the City and use it for tourism promotion and tourism development in the City. The commission shall not use any of the room tax revenue to construct or develop a lodging facility.

(3) The Commission shall review and recommend ordinances, expenditures of room taxes, and policies relating to the promotion of tourism in Viroqua to visitors and tourism development.

(4) The Commission shall report annually to the City Council the purposes and amounts for which room tax revenues were spent.

(5) The City shall report annually to the Commission the revenue collected from room tax with lodging detail breakdown.

(6) The Commission shall contract with a qualified organization under Section 66.0615, Wis. Stats. to perform the functions of a tourism entity.

Chapter 2.50HOUSING ADVISORY BOARD

Sections:

2.50.010	Establishment and Mission Statement
2.50.020	Powers and Duties
2.50.030	Membership
2.50.040	Term of Office

2.50.010 Establishment and Mission Statement. The Housing Advisory Board is hereby established. The Housing Advisory Board was created to help identify and create innovative solutions to housing issues within the City of Viroqua. All Board meetings will be open to the public.

2.50.020 Powers and Duties. The Housing Advisory Board shall act in an advisory capacity to the Mayor and Common Council, and its duties shall include:

- A. Advising the Mayor and Common Council on housing issues, strategies, goals and policies;
- B. Studying and recommending to the Mayor and Common Council long and short-term goals and innovative approaches to accomplish the City's housing goals; and
- C. Advising the Mayor and Common Council about the impacts of City policies on housing affordability and accessibility.

2.50.030 Membership. The Board shall consist of eleven (11) members to include two (2) alderpersons, nine (9) citizen members appointed by the Mayor and confirmed by the Common Council. Citizen members shall include one (1) realtor, one (1) landlord and one (1) lender. Citizen members of the Housing Advisory Board shall serve in a volunteer capacity.

2.50.040 Term of Office. Housing Advisory Board Members shall serve for a term of three (3) years and until a successor is appointed, except that of those Board members initially appointed three (3) shall serve terms of one (1) year, four (4) shall serve terms of two (2) years and four (4) shall serve terms of three (3) years.

Title 3REVENUE AND FINANCEChapters:

- 3.04 Fiscal Procedure
- 3.12 Special Assessments
- 3.14 Volunteer firefighters' fund account
- 3.16 Cemetery Trust Fund
- 3.18 Confidentiality of information obtained by the Assessor
- 3.20 Retail lodging tax
- 3.22 Fees for certain Fire Department Responses

Chapter 3.04FISCAL PROCEDURESections:

- 3.04.010 Designated.
- 3.04.020 Curb and gutter and sidewalk construction.

3.04.010 Designated. City funds shall be drawn out only by the authority of the Common Council and upon order of the mayor and clerk and shall be countersigned by the City Treasurer-Assessor. Each order shall specify the purpose for which it is drawn and shall be negotiable. The aforesaid shall apply also to the water utility of the City. (Ord. 87 §1, 1936).

3.04.020 Curb and gutter and sidewalk construction. The City is authorized to perform all or any part of public construction of curb and gutter and sidewalks in the City directly without submitting the same for bids. (Ord. 207 §1, 1964).

Chapter 3.12SPECIAL ASSESSMENTSSections:

- 3.12.010 Levying procedure
- 3.12.020 Curb and gutter installations
- 3.12.030 Rough grading of streets
- 3.12.040 Water and sanitary sewer main extensions - Accomplishment alternatives
- 3.12.050 Water and sanitary sewer main extensions -Special assessment procedures
- 3.12.060 Water and sanitary sewer main extensions -Cost advancement procedure
- 3.12.070 Water and sanitary sewer main extensions -Service connections
- 3.12.075 Cost recovery of privately-paid public improvements
- 3.12.080 Payment

3.12.010 Levying procedure. All special assessments levied under this chapter shall be levied in accordance with Chapter 66 of the Wisconsin Statutes and of this chapter, and the charge per front foot, or the total assessment on any one parcel of real estate shall not exceed the benefits and damages thereto as determined by the Common Council. (Ord. 191 §4, 1960).

3.12.020 Curb and gutter installations. A. From and after the effective date of the ordinance codified in this chapter, all curb and gutter installations within the city shall be accomplished on a special assessment basis. Special assessment shall be determined according to benefits and levied on a front foot basis. The amount levied for each front foot of benefited abutting property shall be determined annually by resolution of the Common Council on the basis of previous experience and estimated costs for the coming construction year.

B. Corner lot assessable front footage, for the purpose of this section, shall be limited to that portion of the front footage included between the boundary lines of a parcel of abutting real estate extended rectangularly to the center of the street. (Ord. 191 §1, 1960).

3.12.030 Rough grading of streets. A. From and after the effective date of the ordinance codified in this chapter, all rough grading of streets within the city shall be accomplished on a special assessment basis. Special assessment shall be determined according to benefits and levied on a front foot basis. The amount levied for each assessable front foot of benefited abutting property on each side of the street shall be determined annually by resolution of the Common Council on the basis of previous experience and estimated costs for the coming construction year.

B. Corner lot assessable front footage, for the purpose of this section, shall be limited to that portion of the front footage included between the boundary lines of a parcel of abutting real estate extended rectangularly to the centerline of the street. In addition to such limitation, in cases where a single parcel of real estate abuts directly on two or more streets, the maximum assessable front footage, including front footage on which special assessments for rough grading of streets were previously paid, if any, shall not exceed two-thirds of the aggregate front footage of such parcel of real estate. (Ord. 191 §2, 1960).

3.12.040 Water and sanitary sewer main extensions – Accomplishment alternatives. From and after the effective date of the ordinance codified in this chapter, all water and sanitary sewer main extensions shall be accomplished on either a special assessment or cost advancement basis. (Ord. 191 §3(part), 1960).

3.12.050 Water and sanitary sewer main extensions – Special assessment procedure. A. Water and sanitary sewer main extensions shall be financed by special assessments when deemed advisable by the Common Council. In general, the special assessment method shall be used for main extensions to service areas in immediate need of service or which are deemed likely to develop and need service within ten years, and to serve property in the commercial or industrial zones and property in use for residential purposes as of July 1, 1990. (Ord. 421, §1, 1990).

B. Special assessments shall be determined according to benefits and shall be levied on a front foot basis. The amount levied for each assessable front foot of benefited abutting property on each side of the street shall be determined annually by resolution of the Common Council on the basis of previous experience and estimated costs for the coming year.

C. Corner lot assessable front footage, for the purposes of this section, shall be limited to that portion of the front footage included between the boundary lines of a parcel of the abutting real estate extending rectangularly to the centerline of the street. In addition to such limitation, in cases where a single parcel of real estate abuts directly on two or more streets, the maximum assessable front footage, including front footage on which special assessments for water and sanitary sewer main extensions were previously paid, if any, shall not exceed two-thirds of the aggregate front footage of such parcel of real estate. (Ord. 191 §3(a), 1960).

3.12.060 Water and sanitary sewer main extensions – Cost advancement procedure.

A. Water and sanitary sewer main extensions shall be financed by cost advancements when deemed advisable by the Common Council. In general, the cost advancement method shall be used only when application is made for public water or sanitary sewer service which would require the extension of mains through sparsely occupied areas to serve the applicant, or through areas which in the judgment of the Common Council are unlikely to develop extensively within the next ten years. Where extensions are authorized on a cost advancement basis, the procedure shall be as follows:

1. The applicant shall deposit with the city treasurer -assessor a sum sufficient to pay the total estimated cost of the extension, less unapportionable costs, if any.

2. Such deposit shall be made before construction is started or contracted. If the actual apportionable cost is less than the amount deposited, the excess of the deposit over the cost shall be refunded to the applicant within thirty days after the payment for the completed project. If the apportionable cost exceeds the deposit, the applicant shall pay the difference prior to the granting of water or sanitary sewer service.

3. Any property connected to such main after its installation, other than that of the applicant, shall pay to the city a connection charge determined by the Common Council which shall be equivalent to the amount of the front foot special assessment which would have been levied by the city at the time such extension was made.

4. All connection charges collected by the city under subdivision 3 of this subsection shall be paid to the applicant or his assigns or heirs unless specifically provided otherwise in writing.

B. For the purpose of this section, "unapportionable costs" includes any additional expenses incurred for the installation of water mains in excess of six inches in diameter, or for sanitary sewer mains in excess of eight inches in diameter; for fire protection service; and for one hundred percent of the cost of mains in street intersections. (Ord. 191 §3 (B, C), 1960).

3.12.070 Water and sanitary sewer main extensions – Service connections. The expense of laying service pipes from water and sanitary sewer mains to the curb and of connecting such service pipes with the mains shall be charged to and is made a lien upon the real estate to be served by such service pipes. All such service pipes shall be laid and maintained and such connections made in accordance with the rules and regulations of, and under the supervision of, the water utility and sewer department at the expense of such property. No water or sanitary sewer service shall be granted until such expense has been paid. If said expense is not paid within thirty days after the completion thereof, the same shall be levied and collected as a special tax upon the real estate so to be served, in accordance with the provisions of Section 62.16 (2) (a) of the Wisconsin Statutes. (Ord. 191 §3 (D), 1960).

3.12.075 Cost recovery of privately-paid public improvements. For any public improvement made after the effective date of this section which, in the judgment of the Common Council, may properly be specially assessed against property, and for which the whole cost is advanced by a developer, the City may refund to the developer the amounts assessed against property other than the developer's property, when such assessments are paid to the City. (Ord 10OR010, September 2010)

3.12.080 Payment. Unless otherwise provided in the preliminary or final special assessments resolutions, all special assessments levied under this chapter may be paid in ten equal installments, with interest which the Common Council may adjust annually during the term of payment according to the cost to the City of borrowing, as shall be determined from time to time by resolution of the Common Council, all in accordance with the provisions of law. The Common Council may, by resolution, permit the deferred payment of special assessments of unplatted and undeveloped property until the property is connected to the main, but not longer than ten years following the date of the levy, in accordance with the provisions of law. (Ord. 421, §2, 1990; Ord. 227, §1, 1968; Ord. 192, §1, 1960; Ord. 191 §5, 1960).

Chapter 3.14

VOLUNTEER FIREFIGHTERS' FUND ACCOUNT

Sections:

- 3.14.010 Definitions.
- 3.14.020 Authorized deposits and expenditures
- 3.14.030 Limitations, requirements.
- 3.14.040 Ownership of funds.

3.14.010 Definitions. In this chapter:

A. "Fire volunteer funds" means funds of a municipality that are raised by employees of the municipality's fire department, by volunteers, or by donation to the fire department, for the benefit of the municipality's fire department.

B "Public depository" means a federal or state credit union, federal or state savings and loan association, state bank, savings and trust company, federal or state savings bank, or national bank in the City of Viroqua which receives or holds any public deposits or the local government pooled-investment fund.

C. "Volunteer funds" means fire volunteer funds

3.14.020 Authorized deposits and expenditures.

A. The treasurer of the fire department is authorized to deposit volunteer funds in an account in the name of the fire department, in a public depository.

B. The fire department, through the treasurer, has exclusive control over the expenditure of volunteer funds of the department in such account.

3.14.030 Limitations, requirements.

A. Withdrawals from said account may be made for the benefit of the fire department and the community.

B. Said account is subject to audit by the City's auditor.

3.14.040 Ownership of funds. Notwithstanding the foregoing, volunteer funds shall remain the property of the municipality until the funds are disbursed. (Ord. 551, 2003)

Chapter 3.16

CEMETERY TRUST FUND

Sections:

3.16.010 Donations – City as recipient and trustee.

3.16.020 Donations – Recordkeeping – Interest payments.

3.16.010 Donations – City as recipient and trustee. The city shall receive and hold in trust money from any person, firm or corporation, the income of which is to be used for the care and improvement of the Viroqua Cemetery and of private lots and their appurtenances located within such cemetery. (Ord. 26 §1, 1909).

3.16.020 Donations – Recordkeeping – Interest Payments. The money received from any person, firm or corporation shall, unless otherwise directed by the donor, be paid to the treasurer-assessor of the city, who shall give a receipt therefor which shall be recorded in some appropriate book to be kept for that purpose. In such book shall be stated the amount received from each donor and the specific purpose to which the use thereof is appropriated. Money so received, unless otherwise directed by the donor, shall be paid into the general fund of the city.; The city shall thereafter be perpetually liable for five and one -half percent thereof annually, or, if the municipality concerned can at any time borrow the same amount of money for a rate of interest less than five and one -half percent, then for such lesser rate of interest annually, to be paid to the treasurer of the Viroqua Cemetery Association, to be expended for the purpose and in the manner designated by the donor, by and under the direction of the superintendent of such cemetery association. (Ord. 241, 1972; Ord. 26 §2, 1909).

Chapter 3.18

CONFIDENTIALITY OF INFORMATION OBTAINED BY THE ASSESSOR

Section:

3.18.010 Income and expense information.

Section 3.18.010: Whenever the Assessor, in the performance of the Assessor's duties, requests or obtains income and expense information pursuant to Section 70.47(7)(af), Wis. Stats., or any successor statute thereto, then, such income and expense information that is provided to the Assessor shall be held by the Assessor on a confidential basis, except, however, that the information may be revealed to and used by persons: in the discharging of duties imposed by law; in the discharge of duties imposed by office (including, but not limited to, use by the Assessor in performance of official duties of the Assessor's office and use by the Board of Review in performance of its official duties); or pursuant to order of a court. Income and expense information provided to the Assessor under Section 70.47(7)(af), unless a court determines that it is inaccurate, is per Section 70.47(7)(af), not subject to the right of inspection and copying under Section 19.35(1), Wis. Stats. (Ord. 501, 1999)

Chapter 3.20IMPOSING A ROOM TAX FOR TOURISM PROMOTION AND DEVELOPMENTSections:

3.20.010	Definitions
3.20.020	Imposition of Tax
3.20.030	Amount Owner May Retain for Administration
3.20.040	Collection of Tax
3.20.050	Records to be Maintained
3.20.060	Confidentiality
3.20.070	Distribution of Room Tax Collected
3.20.080	Tracking and Reporting of Room Tax Expenditure
3.20.090.	Penalties

3.20.010 Definitions.

A. "Hotel" or "motel" means a building or group of buildings in which the public may obtain accommodations for a consideration, including, without limitation, such establishments as inns, motels, tourist home, tourist houses or courts, lodging houses, rooming houses, summer camps, apartment hotels, resort lodges, beds and breakfasts including Airbnb and similar services, and cabins and any other building or group of buildings in which accommodations are available to the public irrespective of whether membership is required for use of the accommodations, except accommodations rented for a continuous period of more than one (1) month and accommodations furnished by any hospitals, sanitariums, or nursing homes, or by corporations or associations organized and operated exclusively for religious, charitable, or educational purposes provided that no part of the net earnings of such corporations and association inures to the benefit of any private shareholder or individual and further excluding any accommodations located within a private residence not normally held out to use by the public and which are not used for public accommodations more than ten (10) days in any calendar year.

B. "Gross receipts" means total revenue received from the retail furnishing of rooms, lodging, or similar accommodations by a hotel or motel as defined herein.

C. "Tourism" means travel for recreational, business or educational purposes.

D. "Tourism promotion and tourism development" means any of the following that are significantly used by transient tourists and reasonably likely to generate paid overnight stays at more than one establishment on which a tax under this section may be imposed.

1. Marketing projects, including advertising media buys, creation and distribution of printed or electronic promotional tourist materials, or efforts to recruit conventions, sporting events, or motor coach groups.
2. Tourist informational services.
3. Tangible municipal development, including a convention center.

E. "Transient" means any person, firm, corporation, or entity residing for a continuous period of less than one (1) month in a hotel, motel, or other furnished accommodations available to the public. Excluding from the definition of transient shall be all state employees or officials, employees of any state agency, officials or employees of any political subdivision of the state, and officials or employees of any municipal corporation provided, however, said individual(s) is/are acting within his/her/their employment or official capacity.

3.20.020 Imposition of Tax.

Pursuant to the provisions of sections 66.0615, Wisconsin Statutes, a tax is hereby imposed on the privilege of furnishing, at retail, rooms or lodging to transients by hotelkeepers, motel operators, and other persons furnishing accommodations that are available to the public. The tax is 6% of the amount charged for such rooms, lodging or accommodations.

3.20.030 Amount Owner May Retain for Administration.

The person who provides the accommodations and collects the tax may retain 0.5% of the amount charged for such rooms, lodging or accommodations for administration. (Ord. 531, 2003)

3.20.040 Collection of Tax.

A. Administration by City Administrator. This tax shall be administered by the City Administrator.

B. Reporting Periods. The tax owed shall be reported and paid in quarterly installments, with the report and tax owed for the first quarter of the year due by April 30, the report and tax owed for the second quarter of the year due by July 30, the report and tax owed for the third quarter of the year due by October 30, and the report and tax owed for the fourth quarter of the year due by January 30. A person subject to the tax may make estimates of the amount owed by using the amounts reported in the prior calendar year.

C. Reporting Form. The report filed with the City Administrator and shall be in substantially the following form:

REPORT OF ROOM TAX

For the period beginning _____ and ending _____

THIS TAX RETURN IS CONFIDENTIAL INFORMATION NOT AVAILABLE FOR PUBLIC INSPECTION

- 1. Gross receipts from furnishing rooms and lodging for this period: \$ _____ 1.
- 2. Less: gross receipts from tax-exempt sales for this period: - \$ _____ 2.
- 3. Subtotal:\$ _____ 3.
- 4. Less: credit card charges on non-exempt sales for this period: - \$ _____ 4.
- 5. Subtotal:\$ _____ 5.
- 6. Gross tax (line 5 X 0.06): \$ _____ 6.
- 7. Less: Owner’s exclusion (line 5 X 0.005): \$ _____ 7.
- 8. Net tax for this period (subtract line 7 from line 6): \$ _____ 8.
- 9. Less: any estimated tax paid for this period: - \$ _____ 9.
- 10. Balance of tax owed for this period: \$ _____ 10.

I hereby declare all information given above is true and correct to the best of my knowledge:

Owner’s name: _____

Owner’s address: _____

Owner’s signature and date: _____ Date: _____

D. Sale or Conveyance of Business. If any person, firm, corporation, or entity liable for any amount of tax under this Ordinance sells out his/her business or stock of goods or quits the business, his/her successors or assigns shall withhold a sufficient portion of the purchase price to cover such amount until the former owner produces a receipt from the City Administrator that he/she has paid all tax due hereunder or a certificate stating that no amount is due. Any person, firm, corporation, or entity who by said purchase becomes subject to the tax imposed by this Ordinance fails to withhold such amount of tax from the purchase price as required, he/she shall become personally liable for payment of the amount required to be withheld by him/her to the extent of the price of the accommodations valued in money.

E. Determination of Tax by Audit.

1. The City Administrator or his/her agent(s) may, by office audit, determine the tax required to be paid to the City or the refund due to any person, firm, corporation, or entity under this Ordinance. This determination may be made upon the basis of the facts contained in the return being audited or on the basis of any other information within the City Assessor's possession. One (1) or more such office audit determinations may be made of the amount due for anyone or for more than one (1) period.

2. Upon seven (7) days written notice, the City Administrator or his/her agent(s) may by field audit, determine the tax required to be paid to the City or the refund due to any person, firm, corporation, or entity under this Ordinance. The determination may be made upon the basis of the facts contained in the return being audited or upon any other information within the City Assessor's possession. The City Administrator or his/her agent(s) is authorized to examine and inspect the books, records, memoranda, and property of any person, firm, corporation, or entity in order to verify the tax liability of that person, firm, corporation, or entity or of another person, firm, corporation, or entity. Nothing herein shall prevent the City Administrator from making a determination of tax at any time.

F. Failure to File Return.

1. If any person, firm, corporation, or entity fails to file a return as required by this section, the City Administrator shall determine the tax according to his/her best judgment on the basis of what amount of taxes the City determines to be due. The City Administrator shall compute and determine the amount required to be paid to the City and in addition add to said sum interest at the rate of 1% per month on the unpaid balance. In addition, all tax due hereunder shall become a lien on the real property from which said tax was derived.

2. If any person, firm, corporation, entity that is subject to the tax imposed by this Ordinance fails to pay the tax due, such person, firm, corporation, or entity, in addition to the tax due, shall pay a penalty on said amount due that is the lesser of 25% of the tax due for the previous year or \$5,000.00. All taxes and penalties shall bear interest at the rate of 1% per month on the unpaid balance shall be charged for that period of time that said tax and interest remains unpaid. All tax due hereunder shall become a lien on the real property from which said tax was derived.

3.20.050 Records to be Maintained.

Every person, firm, corporation, or entity liable for the tax imposed by this Ordinance shall keep or cause to be kept such records, receipts, invoices, and other pertinent papers in such form as the City Administrator shall require. Such records shall be retained and made available for a period of five (5) years from the due date of a filing period.

3.20.060 Confidentiality.

All returns, schedules, exhibits, writings, or audit reports relating to such returns on file with the City Administrator may be divulged only to the following and no others:

- A. The person, firm, corporation, or entity who filed the return.
- B. Officers, agents or employees of the Federal Internal Revenue Service or the State Department of Revenue.
- C. Officers, employees, or agents of the City Assessor.
- D. Such other public officials of the City of Viroqua when deemed necessary.

No person, firm, corporation, or entity having administrative duties under this Ordinance shall make known in any manner the business affairs, operations, or information obtained by an investigation of records of any person, firm, corporation, or entity on whom a tax is imposed by this Ordinance, or the amount or source of income, profits, losses, expenditures, or any particulars thereof, set forth or disclosed in any return, or permit any return or copy thereof to be seen or examined by any person, firm, corporation, or entity, except as provided herein. Any person in violation of this subsection shall be subject to penalty set forth below.

3.20.070 Distribution of Room Tax Collected.

Upon receipt of the room taxes, the City shall retain for any public purpose determined by the City Council the greater of either 30% or the maximum amount provided in Section 66.0615(1m)(dm), Wis. Stats., and distribute the remainder to the Tourism Commission for tourism promotion and tourism development as defined in Section 66.0615(1)(fm), Wis. Stats. Any funds not used by the Tourism Commission in a given year shall be placed in a reserve account for future use by the Tourism Commission for the promotion of tourism and tourism development.

3.20.080 Tracking and Reporting of Room Tax Expenditure.

The Tourism Commission shall account for and maintain records of the room tax revenue expenditures. The Tourism Commission shall provide a written report to the City Council no less than annually, in a form and manner determined by the City Council, of all expenditures of at least the minimum as set by Section 66.0651(4), Wis. Stats and the impact of such expenditures on tourism within the City.

3.20.090. Penalties.

In addition to the penalties above set forth, any person, firm, corporation, or entity subject to the tax imposed by this Ordinance who fails to obtain a permit as required hereunder or who fails or refuses to permit inspection of his/her records by the City Administrator after such inspection has been duly requested, or who fails to file a return as provided by this Ordinance, or who violates any provision of this Ordinance, shall upon conviction thereof, and in addition, to any other penalty imposed hereunder, forfeit not less than \$20.00 nor more than \$500.00 and costs of prosecution. Each day or portion of a day that such violation continues is hereby deemed to constitute a separate offense. In addition, all money penalties herein prescribed shall become a lien on the real property that is subject to taxation under this Chapter.

Chapter 3.22IMPOSING FEES FOR CERTAIN FIRE DEPARTMENT RESPONSESSections:

- 3.22.010 Fee imposed for certain responses.
 3.22.020 Fee imposed for Department-controlled burning.

3.22.010 Fee imposed for certain responses. A fee of \$500.00 is hereby imposed for response made by the Viroqua Fire Department to a fire or emergency call under any of the following circumstances:

(A) False Alarms. When the Department receives a report of a fire or other emergency by means of a fire alarm system, and there is in fact no fire or other emergency (a "false alarm"), the owner of the property shall be liable to pay the fee for the third and every subsequent false alarm that occurs within any calendar year to which response is made. "False alarm" does not include an alarm activation signal caused by extraordinary extremes of weather such as high winds, thunder and lightning storms or other systemic electric disturbances, nor by an extraordinary reduction in water pressure caused by others, all as determined by the City.

(B) Motor Vehicle Fires. When the Department responds to a motor vehicle fire, the owner of the vehicle and the operator of the motor vehicle shall be jointly and severally liable to pay the fee.

(C) Use of Extrication Equipment. When the Department responds to a call and uses its extrication equipment (commonly known as "jaws of life" for the ability of the equipment to pry apart motor vehicles), the owner of the motor vehicle, the operator of the motor vehicle, and the person or persons extricated shall be jointly and severally liable to pay the fee.

3.22.020 Fee imposed for Department-controlled burning. A fee of \$500.00 shall be paid before the Department may burn any structure at the request of the owner.

Title 4

(RESERVED)

Title 5BUSINESS LICENSES AND REGULATIONSChapters:

- 5.04 License Fees Generally
- 5.14 Amusement Device Arcades
- 5.16 Cable Television Franchise
- 5.20 Alcohol Beverages
- 5.24 Junk Dealers
- 5.28 Mobile Home Parks
- 5.32 Outdoor Markets
- 5.44 Transient Merchants
- 5.48 Taxicabs
- 5.52 Slaughterhouses

Chapter 5.04LICENSE FEES GENERALLYSections:

- 5.04.010 License Required
- 5.04.020 License Fees
- 5.04.030 Penalty

5.04.010 License Required. No person shall engage in sales of cigarettes or soda water; or in the business of operating a dairy, or salvage yard; or maintain a place where pool and billiard tables, or bowling alleys, or gaming tables (and amusement devices or machines) or vending machines, are open to the public; or engage in sale or furnishing of alcohol beverages; unless with a license issued by the City Clerk.

5.04.020 License Fees. No license shall be issued except upon payment of the following fees:

<u>License:</u>	<u>Fee (annual)</u>
Cigarettes	\$ 5.00
Soda Water	\$10.00
Pool or billiard table	\$15 per table
Bowling alley	\$15 per alley
Dairy	\$25.00
Salvage yard	\$100.00

<u>License</u>	<u>Fee (annual)</u>
Vending machines	\$5.00 per machine
Gaming tables/amusement devices or machines	\$10.00 per table, device, or machine
Class "A" (fermented malt beverages)	\$25.00
Class "B" (fermented malt beverages)	\$100.00
"Class A" (intoxicating liquor)	\$400.00
"Class B" (intoxicating liquor)	\$500.00
Operator's license (alcohol beverages)	\$10.00

5.04.030 Penalty. Any person who violates Chapter 5 of the Viroqua Municipal Code shall be required to forfeit not less than \$50 nor more than \$100 and the costs of prosecution and upon failure to pay such forfeiture shall be imprisoned in the county jail until such forfeiture is paid, not exceeding 30 days. Each day that a violation occurs shall be a separate offense. (Ord 382, 1986; Ord 378, 1986)

Chapter 5.14

AMUSEMENT DEVICE ARCADES

Sections:

5.14.010	Definition
5.14.020	License - Required
5.14.030	License - Issuance
5.14.040	License - Expiration
5.14.050	Supervision and restrictions
5.14.060	Hours restricted
5.14.070	Minors restricted
5.14.080	Interior to be visible from street
5.14.090	Exits
5.14.100	Toilets and washrooms
5.14.110	Penalty - Revocation

5.14.010 Definition. An "arcade" is any premises containing three or more amusement devices for the primary use of entertainment of the public, except premises for which a license to sell alcoholic beverages has been issued by the city. (Ord. 334(a), 1982)

5.14.020 License - Required. No person, firm or corporation shall operate an arcade without first having obtained a license therefor. (Ord. 334 (b), 1982)

5.14.030 License - Issuance. Upon application and proof of compliance with the requirements of this chapter and of any other ordinance of the City of Viroqua, and payment of a licensing fee of five dollars, the city clerk shall issue an arcade license to the applicant. (Ord. 334 (i), 1982)

5.14.040 License - Expiration. The license shall expire June 30th following the date of issuance. (Ord. 334 (j), 1982)

5.14.050 Supervision and restrictions. The licensee or his designated representative shall be on the licensed premises at all times during the hours the arcade is open to the public, in order to provide supervision necessary to maintain proper order. (Ord. 334 (c), 1982)

5.14.060 Hours restricted. No arcade shall be permitted to remain open between the hours of twelve p.m. and nine a.m. of any day. (Ord. 334 (d), 1982)

5.14.070 Minors restricted. No licensee, agent, supervisor, or employee of the licensee shall permit any person under the age of eighteen years to be present upon the premises between the hours of eight a.m. and three-thirty p.m. during any day in which regular classes are held by the Viroqua area schools. (Ord. 334 (e), 1982)

5.14.080 Interior to be visible from street. No license shall be issued for any premises to be operated as an arcade unless the interior of the premises is visible from the street. (Ord. 334 (f), 1982)

5.14.090 Exits. An arcade shall have two easily available, unobstructed and usable exits to the outside. (Ord. 334 (g), 1982)

5.14.100 Toilets and washrooms. An arcade shall have separate, clean, adequate and accessible washrooms and toilets for each sex. (Ord. 334 (h), 1982)

5.14.110 Penalty - Revocation. Any person who shall operate an arcade in violation of this chapter shall, upon conviction, be required to forfeit not less than fifty dollars nor more than two hundred dollars, together with the cost of prosecution and in default of payment thereof, shall be committed to the county jail until such forfeiture and costs are paid, not exceeding thirty days. Each day of violation shall constitute a separate offense. In addition to the imposition of such forfeiture, the council may revoke or suspend any other license issued to such person by the City of Viroqua. (Ord. 334 (k), 1982)

Chapter 5.16CABLE TELEVISION FRANCHISESections:

5.16.010	Purpose
5.16.020	Definitions
5.16.030	Acceptance: Effective Date
5.16.040	Term of Franchise
5.16.050	Revocation of Franchise and Other Penalties
5.16.060	Transfer of Cable Television System
5.16.070	Authority Granted by the Franchise
5.16.080	Franchise Fee
5.16.090	Limitations of Franchise
5.16.100	Additional City Rights in Franchise
5.16.110	Service Area
5.16.120	Time for Providing Service
5.16.130	Condition of Use of Streets
5.16.140	System Design and Channel capacity
5.16.150	Interconnection
5.16.160	Service to Government Buildings
5.16.170	Government and Educational Access provisions
5.16.180	Parental Control Devices
5.16.190	Construction Standards
5.16.200	Operational Standards and Performance Monitoring
5.16.210	Rates and charges
5.16.220	Rights of Individuals
5.16.230	Liability and Indemnification
5.16.240	Insurance
5.16.250	Filing and Communications with Regulatory Agencies
5.16.260	Reports
5.16.270	Franchise Renewal
5.16.280	Franchise Required
5.16.290	Unauthorized Connections or Modifications
5.16.300	Notice
5.16.310	Severability
5.16.320	Captions
5.16.330	Effective Date

Section 5.16.010. PURPOSE The City of Viroqua finds that the continued development of cable communication has the potential of having great benefit and impact upon the citizens of City, because of the complex and rapidly changing technology associated with cable communications, the City further finds that the public convenience, safety and general welfare can be best served by establishing and maintaining regulatory powers

which should be vested in the City or such City officials as the City shall designate. It is the intent of this Ordinance and subsequent amendments to provide for and specify the means to attain the best possible public interest and public purpose in these matters. Further, it is recognized that cable communications systems have the capacity to provide not only entertainment and information services to the County's residents, but can provide additional services.

For these purposes, the following goals underlie the provisions contained herein:

(a) Where economically reasonable, Cable Television Services should be made available to all city residents.

(b) The system should be capable of accommodating both the present and reasonably foreseeable future cable television needs of the citizens of the city.

Section 5.16.020. DEFINITIONS Unless otherwise specifically provided, or unless clearly required by the context, the words and phrases defined in this section shall have the following meanings when used in this Ordinance:

Cable Television Service. the provision of television reception, communications and/or entertainment services for direct or indirect compensation, or as otherwise provided by this Ordinance, and distributing the same over a Cable Television System.

Cable Television System. A facility, consisting of a set of closed transmission paths and associated signal generation, reception, and control equipment that is designed to provide Cable Television Service to multiple subscribers within a community, not including a facility or combination of facilities that serves only to retransmit the television signals of one or more television broadcast stations; or a facility or combination of facilities that serves only subscribers in one or more multiple unit dwellings under common ownership, control or management, unless such facility or facilities use any public right-of-way or public utility easement.

Channel. A portion of the electromagnetic frequency spectrum (or any other means of transmission, including but not limited to optical fibers) which is capable of carrying the equivalent of one (1) six megaHertz television broadcast signal and includes uses of all or any portion of such band of frequencies.

City. The City of Viroqua.

City Council. The City Council of the City of Viroqua, State of Wisconsin.

Commercial Subscriber. All subscribers not defined as either residential or non-commercial. -

FCC. The Federal Communications Commission.

Cable Act. The Cable Communications Policy Act of amended, 47 U.S.C. Section 521 et seq.

Franchise. The nonexclusive rights granted pursuant to this Ordinance to construct, operate, and maintain a Cable Television System along the public rights of way within all of the City. Any such authorization, in whatever form granted, shall not mean or include any license or permit required for the privilege of transacting and carrying on a business with the city as required by other ordinances and laws of the City.

Franchise Agreement. A contract entered into between the City and the Grantee pursuant to this Ordinance, containing additional provisions of the Franchise granted.

Grantee. The person, partnership, firm, or corporation to whom a Franchise, as herein defined, is granted by the City Council under this ordinance and the lawful successor, transferee or assignee of said person, firm, or corporation.

Gross Revenues. The following types of revenue received by a Grantee directly from the operations of a Cable Television System in the City: regular subscriber service fees, per channel pay services, leased channel revenues, converter and remote control rental revenues.

High School. The Viroqua High School.

Service Area The geographical area within the incorporated limits of the City as now exist or hereafter are expanded.

Non-Commercial. Any public educational or governmental institution.

Person. Any individual, firm, partnership, association, corporation, or organization of any kind.

Residential Subscriber. A subscriber who receives the Cable Television Service in a single family home or in an individual dwelling unit of a multiple dwelling, where the service is not to be utilized in connection with a business trade or profession.

Streets. The surface of and the space above and below any publicly owned or maintained property or right-of-way, street, road, highway, freeway, land, path, alley, court, sidewalk, parkway, or drive, now or hereafter existing as such within the city.

Subscriber. Any person or entity lawfully receiving any portion of the Cable Television Service of a Grantee pursuant to this ordinance.

Section 5.16.030 ACCEPTANCE: EFFECTIVE DATE.

(a) Within thirty (30) days after final action granting a Franchise, which shall be done by resolution of the city Council, the Grantee shall file with the City Clerk a written acceptance acknowledged before a Notary Public of the conditions required for the Franchise. Such acceptance shall acknowledge that the Grantee agrees to be bound by and to comply with the provisions of this Ordinance, the Franchise Agreement (if any) and applicable law and shall be in such form and content as to be satisfactory to and approved by the City Attorney. If such acceptance is not filed within said time, then the Franchise so awarded may be deemed void and of no further force and effect and the offer of Franchise so awarded to Grantee may stand revoked, at the option of the city.

(b) Concurrently with the filing of the written acceptance, the Grantee shall file with the City Clerk the bond and insurance certificate required by this Ordinance.

(c) The effective date of the Franchise shall be the first day of the first month next following the date on which the Grantee files the acceptance, bond and insurance certificate as required herein; provided, however, if any of the material required to be filed with the acceptance or the acceptance itself is defective or fails to meet with approval, the Franchise shall not be effective until such defect is cured, or such approval is obtained.

Section 5.16.040. TERM OF FRANCHISE.

The duration of a Franchise granted pursuant to this Ordinance shall not be more than fifteen (15) years from the effective date.

Section 5.16.050. REVOCATION OF FRANCHISE AND OTHER PENALTIES.

(a) Subject to the provisions of this section, City reserves the right to revoke, at any time, any Franchise granted hereunder and rescind all rights and privileges associated therewith in the event that:

(1) Grantee has not substantially complied with a material provision of this Ordinance, the Franchise Agreement, or of any supplemental written agreement entered into by and between the City and the Grantee; or

(2) Grantee has made a material false statement in the application for the Franchise, knowing it to, be false, or Grantee commits a fraud in its conduct or relations under the Franchise with the City; or

(3) Grantee becomes insolvent, enters into receivership or liquidation, files for bankruptcy or assignment for benefit of creditors, is unable to pay its debts as they mature, unless the Grantee is in due process of contesting such debts; or

(4) Grantee fails to comply with any final federal or state judgment arising directly from the exercise of Grantee's rights under its Franchise; or

(5) Grantee fails to provide or maintain in full force and effect the bond and insurance policies required by this Ordinance; or

(6) Grantee assigns, sells or transfers its title or interest in its Franchise without the consent of the City Council.

(b) In the event that the City shall make a preliminary decision to revoke a Franchise granted hereunder, it shall give the Grantee a minimum of sixty (60) days written notice of its intention to terminate and stipulate the cause. A public hearing shall be scheduled for the end of said sixty (60) day period. If during said period, the cause shall be cured to the satisfaction of the City, the City shall declare the notice to be null and void. If the cause is not cured to the satisfaction of the City, before a Franchise may be terminated, the Grantee must be provided with an opportunity to be heard before the city Council in a public hearing in accordance with due process procedures. After the public hearing, if the City determines that the Franchise should be terminated, it/shall issue a written decision containing its findings of fact and stating the specific grounds for termination. The decision to terminate a Franchise shall be subject to judicial review as provided by law.

(c) A Grantee shall not be declared in default or be subject to any sanction under any provision of this Ordinance in any case where the action justifying such sanction is without the Grantee's knowledge or authorization or outside its control.

Section 5.16.060. TRANSFER OF CABLE TELEVISION SYSTEM.

(a) No transfer of control of the Cable Television System other than a pro forma transfer to a parent or a wholly owned subsidiary corporation, or to a partnership with the same general partner as Grantee, or hypothecation as the result of a commercial loan shall take place, whether by force or voluntary sale, lease, assignment, foreclosure, attachment, merger, or any other form of disposition, without prior notice to and approval by the City council, which approval shall not be unreasonably withheld. The notice shall include full identifying particulars of the proposed transaction. For the purpose of determining whether it shall consent to such change, transfer, or acquisition of control, the City may

inquire into the qualifications of the prospective controlling party and the Grantee shall assist the City in any such inquiry. The City shall have ninety (90) days within which to approve or disapprove, by resolution, the proposed transfer of control. If the city fails to act within said ninety (90) day period, the application to transfer control or assign the Franchise shall be deemed to be granted.

(b) Approval of such transfer shall be expressly conditioned upon full compliance with the material terms of the Franchise and this Ordinance. The transferee shall agree in writing to comply with all provisions of this Ordinance and the Franchise agreement.

(c) For the purpose of this section, the term "control" is not limited to majority stock ownership, but includes actual working control in whatever manner exercised. A rebuttable presumption that a transfer of control has occurred shall arise upon the acquisition or accumulation by any person or group of affiliated persons of twenty five (25) percent of the voting shares of the Grantee.

Section 5.16.070. AUTHORITY GRANTED BY THE FRANCHISE

(a) The Grantee of any Franchise granted pursuant to the provisions of this Ordinance shall, subject to the conditions and restrictions set out in this Ordinance, be authorized to construct or have constructed, operate, and maintain a Cable Television System, and to engage in the business of providing Cable Television/Service in the City as defined herein and in the Franchise and for that purpose to erect, install, construct, repair, replace, reconstruct and maintain such poles, wires, cables, conductors, ducts, conduits, vaults, manholes, amplifiers, appliances, attachments, and other property as may be necessary and appurtenant to the Cable Television system; provided, however, that before any pole, wire, or other thing mentioned above which is necessarily and appurtenant to the Cable Television System is placed on or within any Street, the required permits to do so must be obtained by the Grantee from the city; and, provided further, that before any such construction is commenced, the plans and specifications thereof must be approved in writing by the Public Works Director of the City of Viroqua. It shall be unlawful for any telephone, telegraph, or power company or any other public utility company or person to lease or otherwise make available to any person, any poles, lines, facilities, equipment, or other property for use in connection with the operation of a Cable Television System or the provision of Cable Television Service, unless such other person holds a valid Franchise granted pursuant to the provisions of this Ordinance.

(b) The authority granted to a Grantee pursuant to the provisions of this ordinance is not and shall not be deemed to be an exclusive right or permission. The City expressly reserves the right to grant one or more non-exclusive Franchises to operate a Cable Television System to other persons for the entire Franchise area at any time under the

same substantive terms and conditions as apply to the existing Grantee. .No such additional Franchise granted by the city shall in any way affect the obligations of any other Grantee.

(c) If the City grants an additional Franchise under this Ordinance which contains terms deemed more favorable by any existing Grantee, said existing Grantee may elect to incorporate said terms or provisions into its existing Franchise upon notice to the City.

Section 5.16.080. FRANCHISE FEE

The City reserves the right to charge the Grantee a monthly franchise fee, which shall not exceed five percent (5%) of its annual Gross Revenue. The City may impose this franchise fee by providing written notice thereof to the Grantee at least ninety (90) days before commencement of the fee. Grantee may in its discretion, increase Cable Television Services rates or pass through to Subscribers an amount sufficient to recoup the cost of any franchise fee increase.

Section 5.16.090. LIMITATIONS OF FRANCHISE.

(a) In addition to the limitations otherwise herein appearing, the Franchise is subject to the limitation that the Grantee shall at all times during the life of any Franchise hereunder be subject to the lawful exercise of its police power by the City and other duly authorized regulatory state and federal bodies and shall comply with any and all ordinances which the City has adopted or shall adopt applying to the public generally and shall be subject to all laws of the State of Wisconsin and the United States.

(b) Time shall be of the essence in any Franchise granted hereunder. The Grantee shall not be relieved of its obligations to comply promptly with a provision of this ordinance by the failure of the City to enforce compliance. Failure of the City to enforce any breach by the Grantee shall not constitute a waiver by the City.

(c) Any poles, cable, electronic equipment or other appurtenances of the Grantee to be installed in, under, over, along, across or upon a street shall be so located so as to cause minimum interference with the public use of the Street and to cause minimum interference with the rights of other users of the streets or of property owners who adjoin any of the streets.

(d) In the event of disturbance of any street, other public property, or private property by Grantee, it shall, at its own expense and using reasonable efforts, replace and restore property to the condition existing before the work was done.

(e) Grantee shall contract, maintain and operate the Cable Television System so as to cause minimum inconvenience to the general public. All excavations shall be properly guarded and protected. All excavations shall be filled and the surface restored promptly after completion of the work at Grantee's sole cost and expense. The Grantee shall at all times comply with all excavation ordinances of the City.

(f) The Grantee shall, upon reasonable notice from any person holding a building moving permit issued by the City, temporarily alter its facilities to permit the moving of such building. The actual cost of such altering shall be borne by the person requesting the altering and the Grantee shall have the right to request payment in advance. For the provisions of this Ordinance, reasonable notice shall be construed to mean at least seventy-two (72) hours prior to the move.

(g) If, at any time, in case of fire or disaster in the City it shall become necessary in the judgment of the City Manager or the Chief of the Fire Department or their designee to cut or move any of the wires, cable amplifiers, appliances, or appurtenances thereto of the Grantee, such cutting or moving may be done and any repairs rendered necessary thereby shall be made by the Grantee at no expense to the city.

Section 5.16.100. ADDITIONAL CITY RIGHTS IN FRANCHISE.

(a) The City reserves the right upon reasonable notice to require the Grantee at his expense to protect, support, temporarily disconnect, relocate or remove from the Streets any property of the Grantee by reason of traffic conditions, public safety, street construction or excavation, change or establishment of street grade, installation of sewers, drains, water pipes, power or communication lines, tracts, or other types of structure or improvements by governmental agencies. Reasonable notice for this provision of the Ordinance shall be construed to mean at least thirty (30) days except in the case of emergencies where no specific notice period shall be required.

(b) In the event of the failure by the Grantee to complete any work required by subsection (a) above or any work required by City law or ordinance within the time established, the City may cause such work to be done and the Grantee shall reimburse the City the reasonable costs thereof within thirty (30) days after receipt of an itemized list of such cost.

(c) The City reserves the right, in the event of an emergency or disaster, to require the Grantee to make available to the City Manager, upon request, Grantee's audio override, if any, and Community Channel, if any, at no cost, for emergency use during such emergency or disaster period.

(d) The city reserves the right during the life of any Franchise hereunder to inspect, upon reasonable notice, at all reasonable hours, the Grantee's contracts and engineering records dealing with Gross Revenue and technical service provided by Grantee, provided that information pertaining to service to individual subscribers will be available pursuant to Section 631 of the Cable Act.

(e) The City reserves the right during the life of any Franchise granted hereunder, to install and maintain free of charge upon the poles or in the conduits of a Grantee any wire and pole fixtures necessary for municipal networks such as police and fire, on the condition that such installations and maintenance thereof do not interfere with the operations of the Grantee.

(f) The City reserves the right during the life of any franchise granted hereunder, to reasonably inspect all construction or installation work performed subject to the provisions of the Ordinance to ensure compliance with the terms of the Ordinance. At its own expense, the city may also perform measurements upon and randomly inspect any portion of a Grantee's system to ensure compliance with the technical standards under which the Grantee is authorized to operate provided that such measurement or inspection does not interfere with the operation of the Cable Television System.

(g) At any time during the term of the Franchise, and upon thirty (30) days notice, the City reserves the right to hold a public hearing for the expressed purpose of reviewing the general and specific performance of the Grantee with regard to all Franchise provisions contained herein or in any Franchise Agreement issued hereunder.

(h) Any right or power in or duty impressed upon any officer, employee, department, or board of the city shall be subject to transfer by the City Council by law to any other officer, employee, department or board of the city. The city reserves all rights not specifically granted herein, and the enumerations of the rights herein shall not be construed to be a limitation of any right or power the city may otherwise have.

Section 5.16.110. SERVICE AREA.

(a) Subject to the provisions of paragraph (b) of this section, the Grantee of any Franchise hereunder shall offer Cable Television Service to all potential Residential Subscribers who are located within the City Limits as of the effective date of the Franchise. subject to the provisions of paragraph (b) of this Section, the Grantee shall offer Cable Television Service to all potential Residential Subscribers within any area described in any annexation ordinance passed after the passage of this Ordinance, within one (1) year of the effective date of the said annexation ordinance.

(b) The Grantee of any Franchise hereunder shall offer Cable Television Service to all potential Residential Subscribers located within One Hundred Fifty (150) feet of Grantees feeder cable where there exists a minimum density of thirty (30) dwelling units per mile. The Grantee may elect, but has no obligation, to offer Cable Television Service to areas not meeting the above standard.

(c) In the event the continued use of a Street is denied for any reasonable reason related to public health, safety or welfare, the Grantee will make very reasonable effort to provide Residential Service over alternate routes.

Section 5.16.120. TIME FOR PROVIDING SERVICE.

Unless otherwise authorized by the City Council, all areas meeting the requirements of Section 12 (b) subsequent to the effective date of a Franchise granted pursuant to this Ordinance shall be offered Cable Television Service within twelve (12) months of the effective date of the annexation.

Section 5.16.130. CONDITION OF USE OF STREETS.

(a) The poles used for a distribution systems shall be, to the extent possible, those erected and maintained by either a power company or a telephone company, or both. Notwithstanding any other provisions of this Ordinance, no poles except replacements for existing poles shall be erected by or for the Grantee, in any Street, except when necessary to service a subscriber. Any poles, wires, cable or other facilities to be constructed or installed by Grantee on or within the Streets shall be constructed or installed only at such locations and depths and in such a manner as to comply with all state statutes and rules and regulations of the State of Wisconsin, the City, and any other agency of competent jurisdiction.

(b) The installation of trunk and distribution lines, including service drops to subscribers, shall be made underground in areas where both telephone and power lines are underground or are placed underground and the service poles are removed.

Section 5.16.140. SYSTEM DESIGN AND CHANNEL CAPACITY.

The Cable Television System shall be constructed and operated in a manner as set forth in this ordinance. The Cable Television system shall have a capacity of at least 300 MHz bandwidth and shall be constructed and operated in a manner as set forth in this Ordinance.

Section 5.16.150. INTERCONNECTION.

Where economically reasonable and technically possible, Grantee may connect its system with other cable systems adjoining it so as to provide the widest possible combination of programming in the most efficient manner.

Section 5.16.160 SERVICE TO GOVERNMENT BUILDINGS.

(a) The Grantee shall, upon request therefore, provide and furnish without charge to all public educational institutions and governmental buildings within the Service Area and within 150 feet of Grantee's existing distribution cable, one (1) service outlet. The institutions shall be entitled to receive, free of charge, the Grantee's basic cable television service.

Section 5.16.170. GOVERNMENT AND EDUCATIONAL ACCESS PROVISIONS.

(a) Grantee shall provide to each of its Subscribers who receive all, or part of, the total services offered on the System, reception on at least one (1) specially designated noncommercial government and educational access channel on the basic service tier. The specially designated access channel may be used by local education authorities and local government. During those hours that the specially designated access channel is not being used by the local educational authorities, or local government, the High School shall have the limited right to program a character generator and to sell only non-video advertising on such character generator. The High School may also use the specially designated access channel for local origination during those hours when the channel is not in use by the local educational authorities or local government. The VHF spectrum must be used for the specially designated access channel required in the section.

(b) Grantee shall have no obligation to purchase or provide access equipment or to maintain, repair or replace any access equipment.

Section 5.16.180. PARENTAL CONTROL DEVICES.

The Grantee shall at all times have available parental devices for the purpose of controlling premium television programming on individual subscriber television sets. The Grantee shall have the right to charge reasonable fees for the use of such devices.

Section 5.16.190. CONSTRUCTION STANDARDS.

(a) Grantee shall construct, install, operate and maintain the Cable Television System in a manner consistent with all laws, ordinances, construction standards, governmental requirements and the construction and operational standards contained in this Ordinance and any Franchise Agreement.

(b) All installation and maintenance of electronic equipment shall be of a permanent nature, durable and installed in accordance with the applicable sections of the National Electric Safety Code, the National Electrical Code of the National Bureau of Fire Underwriters and all state and local codes where applicable.

(c) Antenna supporting structures (towers) shall be painted, lighted, erected and maintained in accordance with all applicable rules and regulations of the Federal Aviation Administration and all other applicable local or state codes and regulations.

(d) All construction methods and standards shall conform to standard industry practices at the time of construction, and as specified herein and in any Franchise Agreement.

(e) Any contractor used by a Grantee for construction, installation, operation, maintenance, or repair of system equipment must be properly licensed under the laws of the State to which the contractor is licensed, and all local ordinances.

(f) The City does not guarantee the accuracy of any maps showing the horizontal or vertical location of existing substructures. In public rights-of-way, where necessary, the location shall be verified by excavation.

Section 5.16.200. OPERATIONAL STANDARDS AND PERFORMANCE MONITORING.

(a) The Cable Television System shall be operated in compliance with the service standards established by the National Cable Television Association.

(b) The Grantee shall put, keep and maintain all parts of the system in good condition throughout the entire Franchise term.

(c) The Grantee shall render efficient service, make repairs promptly and interrupt service only for good cause and for the shortest time possible. Such interruptions, insofar as possible, shall be preceded by notice and shall occur during periods of minimum system use.

(1) Service repair response time to a subscriber outage call shall not exceed forty-eight (48) hours except on weekends and holidays or in circumstances beyond the reasonable control of the Grantee; and

(2) Trained technicians shall respond on a twenty-four (24) hour day seven (7) days a week basis whenever ten (10) or more verifiable subscriber complaints of outage are received.

(3) The Grantee shall have a local, publicly listed telephone number. The Grantee shall provide the means to accept complaint calls twenty -four (24) hours a day, seven (7) days a week.

Section 5.16.210. RATES AND CHARGES. Grantee shall file with the city schedules which shall describe all services offered, all rates and charges of any kind, and all terms and conditions relating thereto. Grantee shall have the right to pass through to its subscribers all taxes and fees related to the provision of Cable Television Service and Grantee shall have the right to itemize all such taxes and fees on the customer bills. The City Council reserves the right and authority to regulate and to comment, whether publicly or in private, regarding Grantee's schedule of rates and charges.

Section 5.16.220. RIGHTS OF INDIVIDUALS.

(a) The Grantee shall not deny service, deny access or otherwise discriminate against subscribers or other users, or any citizen on the basis of race, color, religion, national origin, sex or sexual orientation. The Grantee shall comply at all times with all other applicable federal, state and local laws and regulations, and all executive and administrative orders relating to nondiscrimination.

(b) Grantee shall comply with the individual privacy provisions contained in the Cable Act.

Section 5.16.230. LIABILITY AND INDEMNIFICATION.

(a) The Grantee shall, at its sole cost and expense, fully indemnify, defend and save harmless the City, its officers, councils, commissions, and employees against any and all actions, liability, judgments, executions, claims or demands whatsoever by others, including, but not limited to, copyright infringement and all other damages arising out of the installation or operation or maintenance of the Cable Television System authorized herein, whether or not any act of omission complained of is authorized, allowed or prohibited by this Ordinance and any Franchise granted hereunder. Grantee shall further indemnify and save the City harmless against all liabilities to others arising out of such construction, operation and maintenance, including, but not limited to, any liability for damages by reason of, or arising out of, any failure by Grantee to secure licenses from the owners, authorized distributors or licenses of programs to be transmitted or distributed by the Grantee, and against any loss, cost, expense, and damages resulting therefrom, including reasonable attorney's fees, arising out of the Grantee's exercise or enjoyment of this Franchise, irrespective of the amount of any comprehensive liability policy required hereunder.

(b) The foregoing liability and indemnity obligations of the Grantee pursuant to this section shall not apply to damages occasioned by acts of the City, its agents or employees, nor shall it be deemed a waiver of any defense of contributory negligence which the Grantee may assert against the City, its agents or employees.

Section 5.16.240. INSURANCE.

(a) At the time of filing written acceptance of the Franchise, the Grantee shall file with the City Clerk Certificates of Insurance for the following:

(1) A general comprehensive public liability insurance policy, indemnifying, defending and saving harmless the City, its officers, councils, commissioners, agents or employees from any and all claims by any person whatsoever on account of injury to or death of a person or persons occasioned by the operations of the Grantee under the Franchise granted hereunder with a minimum of liability of Three Hundred Thousand Dollars (300,000.00) for personal injury or death of any two or more persons in anyone occurrence. Renewal certificates of such insurance shall be promptly forwarded to the City Clerk as such renewals are made, and such insurance shall be constantly kept in force and effect during the term of this Franchise.

(2) Property damage insurance indemnifying, defending and saving harmless the City, its officers, councils, commissions, agents and employees from and against all claims by any person whatsoever for property damage occasioned by the operation of a Grantee under the Franchise granted hereunder with a minimum liability of Three Hundred Thousand Dollars (\$300,000.00) for property damage to anyone person and Five Hundred Thousand Dollars (\$500,000.00) for property damage to two or more persons in anyone occurrence.

(b) Such insurance as provided for in this section shall be provided at the Grantee's sole cost and expense and be kept in full force and effect by the Grantee during the existence of the Franchise and until after the removal of all poles, wires, cables, underground conduits, manholes, and other conductors and fixtures incident to the maintenance and operation of the Cable Television System as defined in the Franchise.

(c) All of the foregoing-insurance contracts shall be issued and maintained by companies authorized to do business in the State of Wisconsin and they shall require thirty (30) days written notice of any cancellation or reduction in coverage to both the City and the Grantee herein.

Section 5.16.250. FILING AND COMMUNICATIONS WITH REGULATORY AGENCIES. The Grantee shall maintain copies of all petitions, applications and communications, relative to any Franchise granted pursuant to this Ordinance transmitted by the Grantee to, or

received by the Grantee from all federal and state regulatory commissions or agencies having competent jurisdiction to regulate the operations of any Cable Television System authorized hereunder Said copies shall be available for inspection by the City during regular business hours of the Grantee.

Section 5.16.260. REPORTS. Upon receiving written notice from the City of commencement of the franchise fee, the Grantee shall file annually with the City Manager not later than four (4) months after the end of its fiscal year during which it imposed the fee hereunder and within four (4) months after the end of each subsequent fiscal year, a letter containing the amount of the Gross Revenues for the previous fiscal year certified by Grantee's controller or chief financial officer.

Section 5.16.270. FRANCHISE RENEWAL. Upon completion of the term of any Franchise granted pursuant to this Ordinance, the procedures for Franchise renewals as established by the Cable Act will apply.

Section 5.16.280. FRANCHISES REQUIRED. It shall be unlawful for any person to construct, operate or maintain a Cable Television System in the City unless such person or the person for whom such action is being taken shall have first obtained and shall currently hold a valid Franchise granted pursuant to this Ordinance. It shall also be unlawful for any person to provide Cable Television Service in the City unless such person shall have first obtained and shall currently hold a valid Franchise granted pursuant to the provisions of this Ordinance. All Franchises granted by the City pursuant to this Ordinance shall contain the same substantive terms and conditions.

Section 5.16.290. UNAUTHORIZED CONNECTIONS OR MODIFICATIONS.

(a) It shall be unlawful for any person without the expressed consent of the Grantee, to make any connection, extension, or division whether physically, acoustically, inductively, electronically, or otherwise with or to any segment of the Cable Television System for any purpose whatsoever.

(b) It shall be unlawful for any person to willfully interfere, tamper, remove, obstruct, or damage any part, segment, or content of a Franchised Cable Television System for any purpose whatsoever.

(c) Any person found guilty of violating this Section may be assessed a fine not to exceed Five Hundred Dollars (\$500.00) or sentenced to thirty (30) days in jail, or both.

Section 5.16.300 NOTICE. Whenever under the terms of the Franchise either party shall be required or permitted to give notice to the other, such notice shall be in writing and if to be served on The city, it shall be delivered either by first class U.S. mail or by handing such notice to the City Manager at the City municipal offices, and if to Grantee, then by delivering by first class U.S. mail or by handing such notice to such officer at such address as Grantee shall from time to time direct. The original name and address of the officer on behalf of the Grantee shall be included in Grantee's acceptance of the Franchise.

Section 5.16.310 SEVERABILITY. If any section, sentence, clause or phrase of this Ordinance is held invalid or unconstitutional, such invalidity or unconstitutionality shall not affect the validity of the remainder of this ordinance, and any portions in conflict are hereby repealed.

Section 5.16.320 CAPTIONS. The captions to sections are inserted solely for convenience and shall not affect the meaning or interpretation of the Ordinance.

Section 5.16.330 EFFECTIVE DATE. This ordinance shall take effect and be in force from and after its adoption by the City Council of the City of Viroqua, State of Wisconsin. Any previously adopted Cable Television Franchise Ordinance and any amendments thereto, are hereby repealed.

Chapter 5.20INTOXICATING LIQUORS AND FERMENTED MALT BEVERAGES

The Common Council of the City of Viroqua ordains as follows:

Sections:

5.20.010	Definitions
5.20.020	License Required
5.20.030	Classes of Licenses
5.20.040	Operator's Licenses and Provisional Operator's Licenses
5.20.050	Expiration
5.20.060	License Fees
5.20.070	Application for License
5.20.080	Qualifications of Applicants
5.20.090	Procedure for Consideration of License
5.20.100	Hours of Operation
5.20.110	Licensed Person on Premises
5.20.120	Restrictions on Firearms
5.20.130	License Conditions and Restrictions
5.20.140	Revocations, Suspensions, Refusals to Issue or Renew
5.20.150	Judicial Review
5.20.160	Penalties

5.20.010 Definitions.

A. "Alcohol beverages" means fermented malt beverages and intoxicating liquor.

B. "Fermented malt beverages" means any beverage made by the alcohol fermentation of an infusion in potable water of barley malt and hops, with or without unmalted grains or decorticated and degerminated grains or sugar containing 0.5% or more of alcohol by volume.

C. "Intoxicating liquor" means all ardent, spirituous, distilled or vinous liquors, liquids or compounds, whether medicated, proprietary, patented or not, and by whatever name called, containing 0.5% or more of alcohol by volume, which are beverages, but does not include "fermented malt beverages."

D. "Wine" means products obtained from the normal alcohol fermentation of the juice or must of sound, ripe grapes, other fruits or other agricultural products, imitation wine, compounds sold as wine, vermouth, cider, perry, mead and sake, if such products contain not less than 0.5% nor more than 21% of alcohol by volume.

5.2.020 License Required. No person, firm or corporation shall vend, sell, deal or traffic in or, for the purpose of evading any law or ordinance, give away any intoxicating liquor or fermented malt beverage in any quantity, or cause the same to be done, without having procured a license as provided in this Chapter nor without complying with all the provisions of this Chapter, and all statutes

and regulations applicable thereto, except as provided by Wis. Stat. §§ 125.16, 125.27, 125.28 and 125.51.

5.20.30 Classes of Licenses.

A. Class A Licenses.

1. Retail "Class A" Intoxicating Liquor License. A Retail "Class A" Intoxicating License authorizes the retail sale of intoxicating liquor for consumption off premises where sold and in original packages, containers and bottles. No more than ten (10) Retail "Class A" Intoxicating Liquor Licenses shall be issued.

2. Retail Class "A" Fermented Malt Beverages License. A Retail Class "A" Fermented Malt Beverages License authorizes retail sales of fermented malt beverages for consumption off the premises where sold and in original packages, containers and bottles.

B. Class B Licenses.

1. "Class B" Intoxicating Liquor License. A "Class B" license authorizes the sale of intoxicating liquor to be consumed by the glass only on the premises where sold and authorizes the sale of intoxicating liquor in the original package or container, in multiples not to exceed 4 liters at any one time, to be consumed off premises, except that wine may be sold in the original package or otherwise in any quantity to be consumed off the premises. The quota of "Class B" licenses that may be issued by the City of Viroqua is controlled by Wis. Stat. §125.51(4).

2. Class "B" Fermented Malt Beverages License. A Class "B" Fermented Malt Beverages License authorizes the sale of fermented malt beverages to be consumed either on the premises sold or off the premises.

3. Temporary Class "B" Fermented Malt Beverage License. Temporary Class "B" Fermented Malt Beverage Licenses may be issued to bona fide clubs and chambers of commerce, to county or local fair associations or agricultural societies, to churches, lodges or societies that have been in existence for at least 6 months before the date of the applications, and to posts of veterans organizations authorizing the sale of fermented malt beverages at a particular picnic or similar gathering, at a meeting of the post, or during a fair conducted by the fair association or agricultural society.

4. Temporary Class "B" Wine License. Temporary Class "B" Wine Licenses may be issued to bona fide clubs and chambers of commerce, to county or local fair associations or agricultural societies, to churches, lodges or societies that have been in existence for at least 6 months before the date of the applications, and to posts of veterans organizations authorizing the sale of wine in an original package, container, or bottle or by the glass if the wine is dispensed directly from an original package, container or bottle at a particular picnic or similar gathering, at a meeting of the post, or during a fair conducted by the fair association or agricultural society. Except as provided for in Wis. Stat. §125.51(b), not more than 2 licenses may be issued to any entity within a 12-month period.

C. Class C Licenses.

1. Retail "Class C" Wine License. A "Class C" license authorizes the retail sale of wine by the glass or in an opened original container for consumption on the premises where sold.

5.20.040 Operator's Licenses and Provisional Operator's Licenses.

A. Operator's License. The City may issue an operator's license in accordance with Wis. Stat. §125.17. Operator's licenses may be issued only upon written application.

B. Provisional Operator's License. The City Clerk may issue a provisional operator's license to an applicant who is entitled to provisional license in accordance with Wis. Stat. §125.17(5).

5.20.050 Expiration. All licenses issued under this Chapter, except Temporary Class "B" Licenses, are valid from issuance until the following June 30th. Temporary Class "B" Licenses are valid for the dates issued.

5.20.060 License Fees.

A. The following license fees shall apply to licenses issued pursuant to this Chapter.

License Type	Fee
Operator's License	\$ 15.00 per year
Provisional Operator's License	\$ 5.00
"Class A"	\$ 500.00 per year*
Class "A"	\$ 25.00 per year
"Class B"	\$ 500.00 per year*
Class "B"	\$ 100.00 per year*
"Class C"	\$ 100.00 per year*
Temporary Class "B" License	\$ 10.00
Reserve "Class B" License	\$10,000.00 Reserve License fee plus \$500.00 per year.*

*Licenses can be issued at any time of the year and annual fees will be prorated for any fraction of a year.

B. The City Clerk shall issue each license approved by the Common Council and shall make the same available at City Hall. Any license for which the fee is not paid within fifteen (15) days of approval of the application by the Common Council shall be returned to the Common Council for cancellation or other disposition.

5.20.070 Application for License.

A. Applications shall be made in writing on the form prescribed by the Wisconsin Department of Revenue and shall be sworn by the applicant. Applications shall be filed with the City Clerk.

B. All applications for Class A, Class B and Class C licenses shall provide a physical description of the premises to include every room and storage space to be covered by the license, including all rooms not separated by a solid wall or joined by connecting entrances.

C. Applications for Temporary Class "B" Licenses shall be filed with the City Clerk at least twenty-four (24) hours prior to granting of the license. All other license applications shall be filed with the City Clerk at least fifteen (15) days prior to the granting of the license.

D. The City Clerk shall publish each application for "Class A", Class "A", "Class B", Class "B" and "Class C" licenses once in the official City newspaper prior to its issuance in accordance with Wis. Stat. §125.04(3)(g). The costs of publication shall be paid by the applicant at the time the application is filed as determined by Wis. Stat. §985.08. Applications for Temporary Class "B" Licenses will not be published.

E. Whenever anything occurs to change any fact set out in the application for any license, such licensee shall file written notification of such change with the City Clerk within ten (10) days after the occurrence thereof.

5.20.080 Qualifications of Applicants.

A. Natural Persons. Licenses related to alcohol beverages issued to natural persons may be issued only to persons who fulfill all of the following requirements:

1. Do not have an arrest or conviction record, subject to Wis. Stats. §§ 111.321, 111.322, 111.335, and 125.12(1)(b);
2. Have been residents of this state continuously for at least ninety (90) days prior to the date of the application;
3. Have attained legal drinking age;
4. Have submitted proof pursuant to Wis. Stat. §77.61(11) that they are in good standing for sales tax purposes; and
5. Have successfully completed a responsible beverage server training within 2 years prior to application as required by Wis. Stat. §125.04(5)(a)(5).

B. Criminal Offenders. No license may be issued, subject to Wis. Stat. §§111.321, 111.322 and 111.335, to any person who has habitually been a law offender or has been convicted of a felony unless the person has been duly pardoned.

C. Corporations and Limited Liability Companies. No license may be issued to any corporation or limited liability company unless that entity meets the following qualifications:

1. Do not have an arrest or conviction record, subject to Wis. Stats. §§111.321, 111.322, 111.335 and 125.12(1)(b);
2. Have submitted proof pursuant to Wis. Stat. §77.61(11) that the entity is in good standing for sales tax purposes;
3. The agent of the entity appointed pursuant to Wis. Stat. §125.04(6) and the officers and directors, or members and managers of the entity meet the following qualifications:
 - a. Do not have an arrest or conviction record, subject to Wis. Stats. §§111.321, 111.322, 111.335 and 125.12(1)(b); and
 - b. Have attained the legal drinking age.

4. The agent of the entity meets the following qualifications:

a. Has been a resident of this state continuously for at least ninety (90) days prior to the date of the application; and

b. Has successfully completed a responsible beverage server training within 2 years prior to application as required by Wis. Stat. §125.04(5)(a)(5).

D. Location of Premises. Except as provided by Wis. Stat. § 125.68 (3), no "Class A" or "Class B" Intoxicating Liquor License may be issued for a premises with a main entrance which is less than 300 feet from the main entrance of any school, hospital or church, except that this prohibition may be waived by a majority vote of the City Council. The distance shall be measured by the shortest route along the highway from the main entrance of the school, church or hospital to the main entrance of the premises covered by the license.

E. Right to Premises. No license shall be issued unless the applicant furnishes proof that the applicant has the right to possession of the premises described in the application for the license by lease, deed or other conveyance.

F. No "Class B" Intoxicating Liquor License shall be issued to any person who does not have a Class "B" Fermented Malt Beverage License.

G. Condition of Premises.

1. No license shall be issued unless the premises conforms to the sanitary, safety and health requirements of the State Building Code and any applicable regulations of the State Board of Health and the local board of health pertaining to restaurants.

2. Prior to the issuance of a new license, and prior to the renewal thereof, the Building Inspector/Zoning Administrator and/or Fire Department shall conduct an on-premises inspection of each premise applying for or holding a license under this Chapter. The license shall not be issued or a renewal granted until any violations discovered as the result of the inspection are corrected. Inspections shall be conducted in sufficient time to allow for a written report to the licensing committee and City Council prior to their consideration of the license. If the application is for renewal, the inspection shall be completed and a written report prepared in sufficient time for consideration at the May meeting of the licensing committee and Common Council.

H. No license shall be issued for operation on any premises or to any applicant for which or whom taxes, assessments, forfeitures or other financial claims of the City, or real estate taxes, are delinquent or unpaid.

5.20.090 Procedure for Consideration of License.

A. Opportunity shall be given by the governing body to any person to be heard for or against the granting of any license. Upon the approval of the applicant by the Common Council, the City Clerk shall issue the applicant a license upon payment by the applicant of the license fee to the City.

B. Consideration for granting or denial of the license will be based upon:

1. The arrest and conviction record of the applicant, subject to the limitations imposed by Wis. Stat. §§11.321, 111.322 and 111.335;
2. The financial responsibility of the applicant;
3. The appropriateness of the location and the premises where the licensed business is to be conducted; and
4. Generally, the applicant's fitness for the trust to be reposed.

C. If the Common Council denies the license, the applicant shall be notified in writing, by registered mail or personal service, of the following:

1. The reasons for denial; and
2. The opportunity to appear before the Common Council and to provide evidence as to why the denial should be reversed. A written request for reconsideration must be filed with the City Clerk within fifteen (15) days of the date of the denial notice.

D. If reconsideration is requested, the City shall inform the applicant that the reconsideration of the application shall be held in closed session pursuant to Wis. Stat. §19.85(1)(b) unless the applicant requests such reconsideration to be held in open session and the Common Council consents to the request. Such written notice shall be mailed or served upon the applicant at least ten (10) days prior to the Common Council meeting at which the application is to be reconsidered.

E. No application for any license which has been denied by the Common Council for any reason shall again be considered by the Common Council for a period of six (6) months from the date of such denial.

5.20.100 Hours of Operation.

A. Class A Hours. No person may sell, dispense or furnish intoxicating liquors or fermented malt beverages on a Class "A" or "Class A" licensed premises between 12 midnight and 8:00 a.m.

B. Class B and Class C Hours. No premises for which a Class "B", "Class B" or "Class C" license is issued may remain open between the hours of 2 a.m. and 6 a.m. except as follows:

1. On Saturday and Sunday the closing hours shall be between 2:30 a.m. and 6:00 a.m., except that on the Sunday that daylight savings time begins, the closing hours shall be between 3:30 a.m. and 6:00 a.m.
2. On January 1st premises operating under a Class B or Class C License are not required to close.
3. Between 12:00 midnight and 6:00 a.m. no person may sell intoxicating liquor or fermented malt beverages in an original unopened package, container or bottle or for consumption away from the premises.

5.20.110 Licensed Person on Premises. Except as provided by Wis. Stat. §§125.32(3)(b) and 125.07(3)(a)(10), no premises operated under a Class "A", Class "B" or "Class C" License may be open for business unless there is upon the premises the licensee, the agent named in the license or some person who has an operator's license and who is responsible for the acts of all persons serving any fermented malt beverages. No person, including a member of the licensee's immediate family operated under a Class "A", Class "B" or "Class C" license may serve fermented malt beverages unless he or she has an operator's license or is at least eighteen (18) years of age and is under the immediate supervision of the licensee, agent or person holding an operator's license who is on the premises at the time of service.

5.20.120 Restrictions on Firearms. No person shall be in possession or bear any firearm or handgun within any public building licensed for the sale of fermented malt beverages or intoxicating liquors except as allowed by Wis. Stat. §941.237.

5.20.130 License Conditions and Restrictions. In addition to the conditions and restrictions imposed by State law on the granting of Class A and Class B fermented malt beverage and intoxicating liquor licenses hereunder, the following conditions and restrictions apply:

A. Consent to Inspection of the Premises. It shall be a condition of any license issued hereunder that the licensed premises may be entered and inspected at any reasonable hour by any police officer of the City without a warrant, and the application for a license hereunder shall be deemed a consent to this provision. If such inspection is denied, such denial shall be deemed a violation of this section.

B. Violations by Agents or Employees. A violation of this Chapter by a duly authorized agent or employee of a licensee shall constitute a violation by the licensee.

C. Sales to Underage Persons Prohibited. No alcohol beverage shall be sold, dispensed, given away or furnished to any person under the legal drinking age unless said person is accompanied by a parent, guardian or spouse who has attained the legal drinking age.

D. Commencement of Operations. Within ninety (90) days after the issuance of a Class A or Class B fermented malt beverage or intoxicating liquor license, the licensee shall be open for business with adequate stock and equipment. Upon the licensee's failure to do business within such time, the license shall be subject to revocation by the Common Council after a public hearing. The Common Council may, for good cause shown, extend such ninety-day period.

E. Cessation of Operations. If any licensee shall suspend or cease doing business for ninety (90) consecutive days or more, the Class A or Class B fermented malt beverage or intoxicating liquor license shall be subject to revocation by the Common Council after a public hearing. The Common Council may, for good cause shown, extend such ninety-day period. An establishment is deemed to have ceased regular operations when any of the following occurs:

1. The license is surrendered to the City Clerk absent the issuance of a newly-granted license;
2. The establishment is not open to the public for a period of ninety (90) days or longer;
3. The establishment is open to the public only intermittently in an attempt to circumvent the provisions of this subsection;

4. The establishment fails to maintain open and active accounts with its food and/or alcohol distributors; or

5. The licensee fails to submit a renewal application to the City Clerk before the submission deadline.

F. Transfer of License. No license shall be transferrable from person to person except as provided by Wis. Stat. §125.04(12)(b) or from place to place except as provided by Wis. Stat. §125.04(12)(a).

5.20.140 Revocations, Suspensions, Refusals to Issue or Renew. The City may revoke, suspend or refuse to renew any license pursuant to Wis. Stat. §125.12 as follows:

A. Revocation or Suspension of Licenses.

1. Complaint. Any resident of the City may file a sworn complaint with the City Clerk alleging one or more of the violations set forth in Wis. Stat. §125.12(2)(ag).

2. Summons. Upon filing of a complaint, the Common Council shall issue a summons, signed by the City Clerk and directed to any peace officer in the municipality. The summons shall command the licensee to appear before the Common Council on a day and place named in the summons, not less than three (3) days and not more than ten (10) days from the date of issuance to show cause why his or her license should not be revoked or suspended. The summons and a copy of the complaint shall be served on the licensee at least three (3) days prior to the time the licensee is commanded to appear. Service shall be in the manner provided by Wis. Stat. Ch. 801 for service in civil actions in circuit court.

3. Procedure for Hearing.

a. If the licensee does not appear, the allegations of the complaint shall be taken as true. If the Common Council finds the allegations sufficient, the license shall be revoked.

b. If the licensee appears and denies the allegations of the complaint, both the complainant and the licensee may produce witnesses, cross-examine witnesses and be represented by counsel. The licensee shall be provided a written transcript of the hearing at his or her expense. If the complaint is found to be true, the license shall either be suspended for not less than ten (10) days nor more than ninety (90) days or revoked. If a person is found to not possess the qualifications required under this chapter to hold a license pursuant to Wis. Stat. §125.51(4)(v) the license shall be revoked.

c. If the Common Council finds the complaint to be untrue or not sufficient to revoke or suspend the license under Wis. Stat. §125.12 the proceeding shall be dismissed without cost to the accused. If the Common Council finds the complaint to be malicious and without probable cause, the costs shall be paid by the complainant.

B. Refusal to Renew Licenses. The City may refuse to renew a license for the causes provided in Wis. Stat. §125.12(2)(ag). Prior to the time for renewal, the Common Council shall provide written notice to the licensee of the City's intention not to renew the license and provide the licensee with an opportunity for a hearing. The hearing shall be conducted as set forth in Section 5.20.140(3).

5.20.150 Judicial Review. The actions of the City Council regarding a refusal to issue a new license, revocation or suspension of a license or failure to renew a license is reviewable by the Vernon County Circuit Court as set forth in Wis. Stat. §125.12(2)(d).

5.20.160 Penalties. Any person who violates any provision of this ordinance shall be required to forfeit not less than \$200.00 nor more than \$500.00, together with the cost of prosecution, and in default of payments of such forfeiture and costs, shall be imprisoned in the county jail until such forfeiture and costs shall be paid, not to exceed thirty (30) days. The City may suspend, revoke or fail to renew the license of any person who violates any provision of this ordinance as set forth in Section 5.20.140.

Chapter 5.24

JUNK DEALERS

Sections:

- 5.24.010 Permit – Required
- 5.24.020 Permit – Application Procedure
- 5.24.030 Permit – Issuance – Term – Cancellation or revocation
- 5.24.040 Licensed premises – Proper enclosure required
- 5.24.050 Violation – Penalty

5.24.010 Permit – Required. No person or persons, association, partnership, firm or corporation shall keep or maintain in the city a junk shop, junkyard or other place for deposit and keeping of old iron, brass or other metal, used motor vehicles or parts thereof, or other articles which, from their worn condition, are practically useless for the purpose for which they were made and which are commonly classed as junk, without first having obtained a permit to do so from the Common Council. (Ord. 167 § 1, 1955).

5.24.020 Permit – Application Procedure. Any person desiring to keep and maintain such shop, yard or other place as defined in Section 5.24.010, shall make application in writing to the Common Council, which application shall be filed with the City Clerk and shall be accompanied by a fee of twenty-five dollars. Such application shall be signed by the applicant and shall set forth the name and residence of the applicant, the correct and accurate description of the premises for which a permit is asked, a statement of the business to be carried on, and an enumeration as nearly as may be of the articles and merchandise to be handled therein. If the applicant is not the owner of the premises for which such permit is asked, such application shall be accompanied by a signed statement of permission from said owner for such proposed use. (Ord. 167 § 2., 1955).

5.24.030 Permit – Issuance – Term – Cancellation or revocation. The Common Council shall, upon receiving such application and fee, issue a permit to keep and maintain such shop, yard or other place referred to in Section 5.24.010, and the person receiving such permit may establish such shop, yard or other place and operate the same, at the location described in said permit, for the term of one year from the date thereof, but said permit may be canceled or revoked by the Common Council, upon proof of the permittee's having violated any of the ordinances of the city or state or state statues, after due notice and hearing thereon. (Ord. 282 § 9, 1977; Ord. 167 § 3, 1955).

5.24.040 Licensed premises – Proper enclosure required. Each of the premises upon which such shop, yard or other place, as defined in Section 5.24.010, is kept or maintained shall be enclosed by a proper fence or other structure not less than eight feet in height and constructed so that no dust or other material may pass through the same. Said enclosure shall be maintained in good condition at all times. No article which is commonly classed as junk shall be kept by the holder of such permit without the limits of such enclosure, and no article shall be kept or piled within such enclosure in such manner that it protrudes above the same. (Ord. 167 § 4, 1955).

5.24.050 Violation – Penalty. Any person, firm, association, partnership or corporation which, by itself or by its agent or employee, violates any of the provisions of this chapter shall, upon conviction thereof, forfeit not less than five dollars nor more than twenty-five dollars to the city with the costs of prosecution for each and every day that such violation continues; and, in default of payment of such forfeiture and the costs of such prosecution, the violator shall be imprisoned in the county jail until the same has been paid, but not to exceed thirty days. (Ord. 167 § 5, 1955).

Chapter 5.28

MOBILE HOME PARKS

Sections:

5.28.010	Statutory reference – Adoption
5.28.020	Parking – Unlawful or restricted acts
5.28.030	Parking – Monthly fee
5.28.040	Licensing – Compliance with and adoption of state administrative code
5.28.050	Licenses – Information on new homes – Collection of parking fees
5.28.060	Violation – Penalty

5.28.010 Statutory reference – Adoption. The provisions of Section 66.058 of the Wisconsin Statutes and the definitions therein are adopted by reference. (Ord. 234 § 1, 1970).

5.28.020 Parking – Unlawful or restricted acts. A. It is unlawful, except as provided in this chapter, for any person to park any mobile home on any street, alley or highway, or other public place, or on any tract of land owned by any person, within the city limits.

B. Emergency or temporary stopping or parking is permitted on any street, alley or highway for not longer than one hour, subject to any other and further prohibitions, regulations or limitation imposed by the traffic and parking regulations or ordinances for that street, alley or highway.

C. No person shall park or occupy any mobile home on any premises which is situated outside an approved mobile home park; provided, that the Common Council may, by resolution permit the parking of mobile homes for such temporary periods, and on such terms and conditions as the Council may set, under the following circumstances:

i) in the commercial district for non -residential purposes when necessary in connection with the relocation of any business or renovation of any building;

ii) for residential purposes when the applicant’s residence has been damaged by fire or other casualty, during the period of reconstruction;

iii) for non -residential purposes during a period when the mobile home is being repaired or renovated. (Ord. 364, 1984; Ord. 322, 1981; Ord. 234, 1970)

5.28.30 Parking - Monthly Fee. There is imposed on each occupied, nonexempt mobile home located in the City a monthly parking fee as determined in accordance with section 66.058 of the Wisconsin Statutes. Said fee shall be paid to the City Treasurer-Assessor on or before the tenth day of the month following the month for which such fee is due. (Ord. 234, 1970)

5.28.040 Licensing - Administrative Code.

A. It is unlawful for any person to establish or operate upon property owned or controlled by him within the City a mobile home park without first having secured a license therefor from the City Clerk. The application for such license shall be accompanied by a fee of two dollars for each space in the existing or proposed park but not less than twenty-five dollars (\$25.00). The license shall expire one year from the date of issuance.

B. Such parks shall comply with AG125 and HSS177 and any other Administrative Code provisions pertaining to mobile home parks. (Ord. 403, 1988; Ord. 234, 1970)

C. Each proposed mobile home park hereafter created shall have public park space dedicated to the City in accordance with the provisions of section 16.12.140 of the Viroqua Municipal Code, including the provision that at least 1,450 square feet of land shall be dedicated for each proposed residential unit. (Ord. 511, 2000)

5.28.050. Licenses - Information - Collection of Fees.

A. Licensees of mobile home parks and owners of land on which are parked any occupied, nonexempt mobile homes shall furnish information to the City Clerk and City Treasurer-Assessor on such homes added to their park or land, within five days after arrival of such home, on forms furnished by the City Clerk in accordance with Section 66.058 of the Wisconsin Statutes.

B. Occupants or owners of nonexempt mobile homes parked outside of a mobile home park shall remit the fees imposed by Section 5.28.030 directly to the city treasurer - assessor as provided in said section. It shall be the full and complete responsibility of the licensee of a mobile home park to collect such fees from each occupied, nonexempt mobile home therein and to remit such fees to the city treasurer - assessor as provided in Section 5.28.030. Nothing contained in this section shall be construed to permit the parking of mobile homes outside of the licensed mobile home parks contrary to the provisions of Section 5.28.020. (Ord. 234, § 5, 1970).

5.28.060 Violation – Penalty. Any person, firm or corporation who fails to comply with any provisions of this chapter shall, upon conviction thereof, forfeit not less than ten dollars nor more than one hundred dollars, together with the costs of prosecution for each violation and, in default of payment thereof, shall be imprisoned in the county jail until payment of such forfeiture and costs, but not to exceed thirty days; provided, that the maximum forfeiture for violation of subsection A of Section 5.28.050 shall be twenty-five dollars. (Ord. 234 § 6, 1955).

Chapter 5.32

OUTDOOR MARKETS

Sections:

- 5.32.010 Sale and handling of agricultural products – Regulations
- 5.32.020 Violation – Penalty

5.32.010 Sale and handling of agricultural products – Regulations. The sale of agricultural products within the city in farmers' or other outdoor market places on public property shall be in accordance with the provisions of this chapter.

The handling and the sale of such products and the premises upon which the same are sold shall be as follows:

- A. Only those items which a farmer actually produces on property owned or rented by him may be sold.
- B. Any item intended for human consumption must be elevated from ground level at least twelve inches.
- C. Items which can be eaten without cooking or peeling, such as plums, cherries, apples, pears, peaches, carrots, radishes, lettuce, tomatoes, and the like, must be protected from dust and vermin.
- D. Food items, such as melons, which cannot be eaten without peeling require no protective covering but must be left whole or properly packaged and must be elevated at least twelve inches.
- E. All garbage and refuse must be handled in such a manner as to preclude any health nuisance.
- F. All scales used in sales under this chapter shall bear a current seal or certificate of inspection and compliance issued by the state.

G. Meat, poultry, fish, dairy products and the like may not be sold at any farmers' market or other outdoor marketplace.

H. The price of each item shall be displayed so as to be readily visible to all patrons.

I. No person shall conduct or use a farmers' or outdoor market on public property except in 3 spaces in the parking lot on North Main Street owned by Felixes, and only upon permit issued by City Clerk which shall be displayed in a prominent place visible to passers-by, and which permit shall exempt the person from municipal regulations limiting parking time. Application for such a permit shall be accompanied by a fee of \$5.00 per day.; The application for such permit shall contain the name and address of the applicant and the nature and extent of items proposed to be sold. No space may be reserved unless occupied by 10:00 o'clock a.m. (Ord. 384, 1986).

J. In addition to the regulations set forth in this section, all the appropriate state and federal laws relating to handling of food and food products and sanitation shall be adhered to. (Ord. 270, 1976).

K. Notwithstanding any other provision of this Chapter, the Common Council may issue licenses to non-profit corporations to sponsor Outdoor markets on streets to be designated by the Council, which street may be closed to vehicle traffic, or limited to motor vehicles used in such Outdoor Markets. The licensee may further sublet the use of space in said street for vendors upon such terms and conditions and for such compensation as the licensee may in writing establish. It shall be a condition of such license that the licensee and its subtenants shall hold the City harmless from any and all loss, cost, damage and liability which may arise because of any act by the licensee or its subtenants during the term of such license. Articles to be sold at such licensed Outdoor Markets shall be within the discretion of the licensee, but all other City ordinances and State laws regulating sales shall be complied with. No person shall occupy or use any part of such City street, nor sell or transfer any article of property from any place on such City street, except in accordance with written regulations of the licensee. (Ord. 419, § 1, 1990).

5.32.020 Violation – Penalty. Any person who violates any provision of this chapter shall, upon conviction, be required to forfeit not less than \$50 nor more than \$200, together with the costs of prosecution, and upon failure to pay such forfeiture and costs shall be imprisoned in the County jail until such forfeiture and costs are paid, not exceeding 30 days. (Ord. 419 § 2, 1990; Ord. 270, 1976).

Chapter 5.44TRANSIENT MERCHANTSSections:

- 5.44.010 Transient merchant defined.
- 5.44.020 License required.
- 5.44.030 Application for license.
- 5.44.040 Fee – Issuance of license – Term.
- 5.44.050 Outdoor markets exempted.
- 5.44.060 Violation – Penalty.

5.44.010 Transient merchant defined. A “transient merchant” is one who, while present in the city, sells or offers to sell merchandise directly to the ultimate user or consumer, or one who, while present in the city, provides or offers to provide personal services directly to the ultimate user or consumer and who does not intend to become a permanent resident of the city or who does not maintain a permanent place of business in the city. (Ord. 32. § 1(a), 1981).

5.44.020 License required. No person shall engage in any business as a transient merchant without a license authorizing him or her to do so, unless such business is first solicited by the ultimate user or consumer. (Ord. 320 § 1(b), 1981).

5.44.030 Application for license. A person desiring to engage in any business as a transient merchant shall obtain a license therefor from the city clerk. The applicant shall state in writing his or her name, address, nature of business, and shall provide proof of identification such as an operator’s license or other evidence of identification of comparable authenticity. If the clerk is in doubt as to the authenticity of other identification, the opinion of the chief of police shall be obtained and shall be conclusive. The application for such license shall bear the signature of the applicant. (Ord. 320 § 1(c), 1981).

5.44.040 Fee – Issuance of license – Term. Upon written application, and proof of identification, and the payment of a fee of five dollars, a license shall be issued which shall be carried upon the person of the licensee and which shall be good for one week, except that it may be renewed weekly thereafter upon payment of one dollar. (Ord. 320 § 1(d), 1981).

5.44.050 Outdoor markets exempted. No transient merchant permit shall be required for any person who is required to obtain a permit under Chapter 5.32, of this code, pertaining to outdoor markets. (Ord. 320 § 1(e), 1981).

5.44.060 Violation – penalty. Any person who violates this chapter shall be required to forfeit not less than fifty dollars nor more than two hundred dollars together with the costs of prosecution, and in default of payment , shall be committed to the county jail until such forfeiture and costs are paid, not exceeding thirty days. Each violation shall constitute a separate offense. (Ord. 320 §2, 1981).

Chapter 5.48

TAXICABS

Sections:

- 5.48.010 License required – duration.
- 5.48.020 License fee.
- 5.48.030 Application.
- 5.48.040 License conditions.
- 5.48.050 Rates displayed.
- 5.48.060 Violation – Penalty.

5.48.010 License – Required – Duration – Applicability. No person shall operate a taxi service upon the streets of the City and within points within the City without a license. A license shall be for one year or part thereof and shall expire December 31.

5.48.020 License – Fees. The license fee shall be \$25 per year or part thereof.

5.48.030 Application – Filing – Required – information. Application for a license shall contain the name and address of the applicant; the rates to be charged; the number and description of the vehicles to be licensed; the names and addresses of the vehicle operators; and a certificate of insurance showing that the applicant has public liability insurance on the vehicles to be operated as taxis and showing that the insurer shall provide the City at least 10 days notice of cancellation of said policy. The applicant shall maintain such insurance in effect during the term of the license.

5.48.040 License – Conditions. All licenses shall be granted and accepted by the applicant upon the following conditions. The City may temporarily suspend the license, pending a hearing, if the licensee fails to comply with any City ordinances or State statutes pertaining to the equipment and operation of motor vehicles or any provision of this ordinance requiring insurance, or if the licensee or agent operates a taxi, or permits some person to operate a taxi, other than the taxi or operator listed in a license application or amendment thereto.

5.48.050 Display of Rates. A taxi shall have prominently displayed the rates of service.

5.48.060 Violations – Penalty. Any person who violates any provision of this ordinance shall be required to forfeit not less than \$50 nor more than \$400 and the costs of prosecution, and upon failure to pay the same shall be committed to the County Jail until such forfeiture and costs are paid, not exceeding 30 days. The City may enjoin a violation or threatened violation of this ordinance.

Chapter 5.52

SLAUGHTERHOUSES

Sections:

- 5.52.010 Defined.
- 5.52.020 Construction of operation – Permit.
- 5.52.030 Construction of operation – License fee.
- 5.52.040 Disposal of waste.
- 5.52.050 Keeping of animals.
- 5.52.060 Hours of operation.
- 5.52.070 Extent of operation.
- 5.52.080 Construction materials – Cleanliness requirement.
- 5.52.090 Adoption by reference of state regulations.
- 5.52.100 Inspection and Investigation – Health Officer’s duty.
- 5.52.110 Revocation of permits.
- 5.52.120 Violation – Penalty.

5.52.010 Defined. “Slaughterhouse” as used in this chapter, includes any place where animals, other than rabbits or poultry, are kept for slaughter or are slaughtered for human consumption, and any place where slaughtered animals other than rabbits or poultry are dressed for human consumption, whether such animals are killed or dressed for private use or for public sale. (Ord. 156 § 1, 1954).

5.52.020 Construction or operation – Permit Required. A. No person, firm or corporation shall construct or operate a slaughterhouse within the corporate limits of the city until such person, firm or corporation has first obtained a permit therefor, and no such slaughterhouse shall be operated within the corporate limits of the city until there has been paid the license fee prescribed in Section 5.52.030. Such permit shall be issued by the city clerk upon the direction of the Council, and such permit shall not be issued until a written request for

same has been presented to the Council for its consideration. Such request for a permit shall set forth the location at which such proposed slaughterhouse is to be constructed or operated and shall describe in detail the type of construction of the building or buildings in which such slaughterhouse is to be operated. Such request for a permit shall further set forth the means proposed for the disposal of liquid and solid waste and manure resulting from or produced by the operation of the proposed slaughterhouse, and shall set forth as accurately as possible the extent of the proposed slaughtering operations.

B. Upon receipt of a written request for a permit for the operation of a slaughterhouse, the Council shall direct the health officer and city engineer to make an inspection of the premises upon which such proposed slaughterhouse is to be operated to determine whether it will meet all the requirements of this chapter and all rules of the State Board of Health and the State Department of Agriculture pertaining to the construction and operation of slaughterhouses. The health officer and the city engineer shall report to the Council the result of such inspection.

C. If the proposed slaughterhouse meets all requirements set forth in this section, the Council may, at its discretion, by resolution direct the city clerk to issue the requested permit. (Ord. 156 §2, 1954).

5.52.030 Construction or operation – License fee – Renewal procedure. A. No person, firm or corporation shall operate a slaughterhouse in the city until there has been paid an annual license fee in the amount of twenty -five dollars. Such license fee shall be paid on or before July 1 of each year and application for renewal of such license shall be made on or before June 1 of each year. In the event that application for renewal is made after June 1 of any year, a ten dollar penalty shall be paid in addition to the annual license fee before a renewal of the license is issued.

B. An application for renewal shall be referred by the city clerk to the Council which shall direct the health officer and city engineer to make an inspection of the premises as provided in Section 5.52.020, for the issuance of an original permit for the construction or operation of a slaughterhouse. Upon receiving the report of the health officer and city engineer as to the results of such inspection, the Council may, by resolution, direct the city clerk to renew such license. Failure to renew such license shall operate as an automatic revocation of the permit prescribed in Section 5.52.020. (Ord. 156 § 3, 1954).

5.52.040 Disposal of waste. A. Liquid waste, including blood, shall be disposed of in the public sewage system of the city with such pretreatment as is deemed necessary by the city engineer and to the extent only that the disposal plant of the sewage system is able to properly care for such wastes. In the event that experience determines that more liquid wastes are produced than can be properly cared for by the public sewage system,

as determined by the city engineer, the excess over and above the amount that can be handled by the public sewage system must be otherwise disposed of at least one mile outside the corporate limits of the city.

B. Solid waste and manure shall be kept in a completely enclosed metal container and shall be removed from the premises occupied by any slaughterhouse once each day after all slaughtering operations for such day have been completed. Such solid waste and refuse shall be disposed of at least one mile outside the corporate limits of the city and shall not be put in the garbage to be disposed of by the city. (Ord. 156 § 4, 1954).

5.52.050 Keeping of animals. Animals intended for slaughter shall be kept in fully enclosed and flyproofed pens, stables or other enclosures, and such pens, stables or other enclosures shall be kept at all times clean and sanitary and in such fashion as not to constitute a nuisance. Animals intended for slaughter shall not be kept in trucks, trailers or other vehicles within the city for longer periods than one-half hour. Animals intended for slaughter shall not be kept in pens, stables or other enclosures at any slaughterhouse in the city for longer periods than eight hours. In no event shall animals intended for slaughter be kept overnight upon the premises of any slaughterhouse with the corporate limits of the city. (Ord. 156 § 5, 1954).

5.52.060 Hours of operation. Livestock shall not be received for slaughtering between the hours of five p.m. of any day and eight a.m. on the following day. Slaughtering operations shall be carried only between the hours of eight a.m. and five p.m. of any weekday. (Ord. 156 § 6, 1954).

5.52.070 Extent of operation. The permit prescribed by Section 5.52.020 shall specify the extent of slaughtering operations that may be carried on under such permit. The resolution of the Council directing the issuance of a permit for the operation of a slaughterhouse shall specifically set forth such limitations on the extent of slaughtering operations as the Council deems necessary in protecting the health, safety and general welfare of the city. (Ord. 156 § 7, 1954).

5.52.080 Construction materials – Cleanliness requirement. Floors, walls and ceilings of any room used for the slaughtering of animals shall be of concrete or other impervious or nonabsorbable materials, and floors shall be equipped with suitable drains and sewers equipped with approved traps and vents. Floors, walls and ceilings shall be kept in good repair to the extent that they remain impervious and nonabsorbable and can be kept clean and sanitary. Floors, walls and ceilings shall be washed each day after all slaughtering operations for such day have been completed. (Ord. 156 § 8, 1954).

5.52.090 Adoption by reference of state regulations. All rules of the State Board of Health and of the State Department of Agriculture applicable to the construction, maintenance, equipment, operation or personnel of slaughterhouses now in effect and all amendments thereof, insofar as such rules and amendments are not inconsistent with this chapter, are adopted by reference and made a part of this section. (Ord. 156 § 9, 1954).

5.52.100 Inspection and investigation – Health officer’s duty. A. The health officer of the city shall make an inspection of the premises of every slaughterhouse operating in the city at various times, but not less than once each month, and shall report in writing to the Council his findings and the result of his inspections. Such inspections shall be for the purpose of determining whether slaughterhouses operating within the corporate limits of the city are complying with the requirements of this chapter and with all rules of the State Board of Health and the State Department of Agriculture relating to the construction, maintenance, equipment, operation or personnel of slaughterhouses.

B. Upon receiving complaint that any condition constituting a nuisance exists upon the premises of any slaughterhouse operating within the corporate limits of the city, the health officer shall make an investigation to determine whether such condition exists and whether such condition constitutes a menace to the public health, safety and welfare of the city, and shall report in writing to the council the results of such investigation. The determination of the health officer as to the existence of a nuisance shall be conclusive for purposes of enforcing this chapter. (Ord. 156 § 10, 1954).

5.52.110 Revocation of permits. A. The Council may, in its discretion, at any time revoke a permit granted for the construction or operation of a slaughterhouse within the corporate limits of the city upon receiving a report from the health officer that any condition exists upon the premises of any licensed slaughterhouse constituting a nuisance and a menace to the public health, safety and welfare of the city.

B. The Council may, in its discretion, at any time revoke a permit granted for the construction or operation of a slaughterhouse within the corporate limits of the city when the person, firm or corporation constructing or operating such slaughterhouse has been convicted of a violation of this chapter or of any of the rules of the State Board of Health or of the State Department of Agriculture relating to the construction, maintenance, operation or personnel of slaughterhouses.

C. Such revocation of a permit shall be in addition to any other penalties prescribed in this chapter. (Ord. 156 § 11, 1954).

5.52.120 Violation – Penalty. Any person, firm or corporation who violates any of the provisions of this chapter shall, upon conviction thereof, be fined not less than twenty -five dollars nor more than two hundred dollars, together with the costs of prosecution, and, in the event such fine and costs are not paid, by imprisonment in the county jail until such fine and costs are paid but not to exceed sixty days. Each day a condition exists in violation of this chapter shall be deemed a separate offense. (Ord. 156 § 12, 1954).

Title 6

ANIMALS

Chapters:

- 6.04 Regulating dogs, cats, and other animals.
- 6.06 Cat licenses and taxes.
- 6.08 Dangerous dogs.
- 6.09 Owning, keeping or harboring chickens.
- 6.12 Cruelty to animals.

Chapter 6.04

REGULATING DOGS, CATS, AND OTHER ANIMALS

Sections:

- 6.04.010 Running at large.
- 6.04.020 Number of dogs and cats permitted per household.
- 6.04.030 Prohibited in parks and cemeteries.
- 6.04.050 Rabies – State law adopted.
- 6.04.070 Rabies – Dogs or cats removed from Animal Shelter.
- 6.04.090 Disturbing the peace.
- 6.04.100 Impounding dogs and other animals.
- 6.04.105 Cooperative agreements with other municipalities.
- 6.04.120 Increase in county license fee.
- 6.04.125 Collecting Officials.
- 6.04.130 Miscellaneous provisions.
- 6.04.140 Certain animals prohibited.
- 6.04.150 Violation – Penalty.

6.04.010 Running at large. No person shall allow any animal to run at large within the City Limits. Any animal not on a leash, nor accompanied by a person who can maintain control of the animal, and off its owner's property, is declared to be "at large", and is declared to be a public nuisance. (Ord 534, 2003)

6.04.020 Number of dogs and cats per household. (a) No person shall keep or harbor more than two dogs nor more than four cats on any lot, premises, dwelling, building, structure or living accommodation in the City of Viroqua. This limit on the number of dogs and cats does not apply to offspring for the first 120 days after the birth of such offspring.

(b) This section shall not apply to a veterinarian keeping or harboring dogs or cats for treatment and/or boarding, nor to Animal Control Facilities or Animal Shelters as defined in Section 173.41 of the Wisconsin Statutes. (ORD 17OR004).

6.04.030 Prohibited in parks and cemeteries. No person shall allow any animal to be upon any park or cemetery in the City Limits, except a person may walk an animal on a leash in the parks. This Section shall not apply to dogs that are in off-leash areas of parks established by Resolution of the Common Council. The City shall post appropriate signs and notices designating off-leash dog areas and indicating rules and regulations applicable to such designated off-leash areas. Failure to comply with the posted rules and regulations shall constitute a violation of this Section and shall be subject to penalties as set forth in Section 6.04.150 of the Viroqua Municipal Code.

6.04.050 Rabies – State law adopted. The owner of a dog or cat shall have the dog or cat vaccinated against rabies by a required age and revaccinated within one year after the initial vaccination, and thereafter before the date that the immunization expires on the certificate of vaccination, or, if no date is specified, within 3 years after the previous vaccination, in the manner required by State law.

6.04.070 Rabies – Dogs or cats removed from Animal Shelter. A person who removes a dog or cat from the animal shelter (whether the former owner or not) shall be required to pay a sum sufficient to cover the cost of rabies vaccination for the dog or cat, and such person shall be given a voucher to be presented to a veterinarian to obtain such rabies vaccination for the dog or cat; the City shall pay such amount to the veterinarian upon presentation of such voucher.

6.04.090 Disturbing the peace. No person shall keep or harbor any dog, cat, or other animal which by frequent or repeated or habitual howling, barking or other sound, disturbs the peace of any person or the public. Any dog, cat, or other animal so disturbing the peace is declared to be a public nuisance.

6.04.100 Impounding dogs and other animals. A suitable enclosure shall be provided by the City as a dog and other animal shelter. The City Police and any authorized agent of the City shall seize and impound any dog or other animal which is running at large, or which is unlicensed, including those without a rabies tag as required by this chapter. The Police, or other authorized agent of the City, impounding such dog or other animals shall notify the owner thereof personally or through the United States mail, if such owner be known to, or can be ascertained with reasonable effort by, such officer or agent, in accordance with the Wisconsin Statutes. Such officer or agent shall carefully read the "Lost and Found" column of local daily newspapers having general circulation in the community to determine whether or not a dog or other animal is therein advertised which answers the description of any such impounded dog or other animal, and shall promptly communicate with the advertiser thereof if such be found. If the owner of such dog or other animal is unknown or cannot be ascertained, then the officer or agent shall post a written notice in three public places in the City, giving a description of the dog or other animal, stating where it is impounded, and the conditions for its release within forty eight hours, Sundays excepted, after such officer or agent shall have taken such dog or other animal into his or her possession. If after seven days from the date of impoundment, the owner does not claim such dog or other animal, such officer or agent shall dispose of the dog or other animal in a proper and humane manner. The owner of any such dog or other animal so impounded shall be liable to the City for the care and confinement of such dog or other animal in the sum of ten dollars plus one dollar per day of confinement, whether or not such dog or other animal is reclaimed by the owner.

Every officer or agent who impounds any such dog or other animal shall keep a record of the disposition of such animal, describing the same with reasonable certainty of identification and listing the name and address of the owner thereof, if known, and the license number and rabies tag number of any such dog or other animal, if known, and the date of impoundment, and disposition.

6.04.105 Cooperative agreements with other municipalities. The Common Council may authorize cooperative agreements with other municipalities for the impoundment in the Viroqua animal shelter of stray dogs found in such other municipalities, upon such terms and conditions as the Common Council may establish by resolution.

6.04.120 Increase in county license fee. The dog license fee established by the county is increased by the sum of fifty cents per license, which shall be levied and collected in the same manner as other dog license taxes, and which amount may be increased by resolution of the council hereafter.

6.04.125 Collecting Officials. The City Clerk and deputy City Clerk are the officials to collect the tax and issue dog licenses. In addition, any veterinarian and any humane society shall be collecting officials, upon the request of any such veterinarian or humane society, who shall then collect the tax and issue dog licenses. (Ord. 537, 2003).

6.04.130 Miscellaneous provisions. (a) The City Assessor shall make a record of all dogs and cats found by the assessor at the time of assessment in the City and report the same to the Council. No person shall lead any animal upon a City Street from a motor vehicle or from a trailer or semitrailer drawn by a motor vehicle. No person may take a dog or cat or other animal of another from one place to another without the owner's consent, excepting officers or duly authorized agents of the City engaged in the exercise of their official duties, or as otherwise permitted in this chapter.

(b) No person who has the care, custody or control of any animal shall allow or permit the animal to defecate upon property not owned by such person, or without such other property owners consent, nor upon any public property, unless the excreta is immediately removed from any such property.

6.04.140 Certain animals prohibited.

(a) No person shall bring into, keep, or maintain in the City any wasps, hornets, poisonous snakes, or any other dangerous or carnivorous wild animal or reptile unless otherwise expressly permitted by this code, or state or federal law.

(b) No person shall bring into, keep or maintain in the City any cows, pigs (including pot-belly pigs), goats, sheep, ducks, geese, horses, mules or the young of any such animals, or any animal raised for fur-bearing purposes unless otherwise expressly permitted by this code, or state or federal law.

(c) Exceptions.

- (i) Animals allowed as a permitted or conditional use in accordance with 17.08.010 for property zoned A-1.
- (ii) Animals that are in the care, custody or control of a veterinarian for treatment.
- (iii) Animals kept on the premises of an itinerant or transient fair, carnival, parade, circus, petting zoo, professional animal acts, rodeo or similar event in the City during the time which that event is being held.
- (iv) Mules or horses used for transportation that are not kept or maintained within the City for more than twenty-four hours.

6.04.150 Violation - Penalty. Any person who violates any provision of this chapter shall, upon conviction, forfeit not more than one hundred dollars and the costs of prosecution, and in default of any payment thereof shall be committed to the county jail for not more than thirty days, unless such forfeiture and costs of prosecution are sooner paid. For a second or subsequent offense, any person who violates any provision of this chapter shall, upon conviction, forfeit not less than fifty dollars nor more than two hundred dollars, and the costs of prosecution, and in default of payment thereof, shall be committed to the county jail for not more than thirty days, unless such forfeiture and costs of prosecution are sooner paid. Nothing contained in this chapter shall prevent the City from proceeding against the owner or keeper of any dog, cat, or other animal, for a violation of this chapter as a public nuisance.

Chapter 6.06CAT LICENSES AND TAXESSections:

6.06.010	Requirement.
6.06.020	Tax.
6.06.030	License Year.
6.06.040	Late fee.
6.06.050	License Requirements.
6.06.060	Collecting Officials.

6.06.010 Requirement. The owner of a cat more than 5 months of age on January 1 of any year, or 5 months of age within the license year, shall annually, or on or before the date the cat becomes 5 months of age, pay the license tax and obtain a license. (Ord. 535, 2003)

6.06.020 Tax. The minimum license tax is \$3.00 for a neutered male or spayed female upon presentation of evidence that the cat is neutered or spayed, and \$8.00 for an unneutered male or unspayed female, or one-half of these amounts if the cat became 5 months of age after July 1 of the license year.

6.06.030 License year. The license year commences on January 1 and ends on the following December 31.

6.06.040 Late fees. The collecting official shall assess and collect a late fee of \$5.00 from every owner of a cat 5 months of age or over, if the owner failed to obtain a license prior to April 1 of each year, or within 30 days of acquiring ownership of a licensable cat or if the owner failed to obtain a license on or before the cat reached licensable age. All late fees received or collected shall be paid into the local treasury as revenue of the City.

6.06.050 License requirements (a) License Required. A cat license is necessary for the keeping of any cat over 5 months of age.

(b) Licenses. Upon payment of the required cat license tax and upon presentation of evidence that the cat is currently immunized against rabies, the collecting official shall complete and issue to the owner a license for the cat bearing a serial number and in the form prescribed by the department stating the date of its expiration, the owner's name and address, and the name, sex, spayed or unspayed, neutered or unneutered, breed and color of the cat.

(c) Copies. The collecting official shall keep a duplicate copy of the license on file.

(d) Tag. After issuing the license the collecting official shall deliver to the owner a tag of durable material bearing the same serial number as the license, the name of the City and the license year.

(e) Tags to be attached. The owner shall securely attach the tag to a collar and a collar with the tag attached shall be kept on the cat for which the license is issued at all times, but this requirement does not apply to a cat during competition or training, to a cat securely confined indoors, to a cat securely confined in a fenced area or to a cat while under the control of its owner.

(f) Duplicate tags. A new tag with a new number shall be furnished to the owner by a collecting official in place of the original tag upon presentation of the license. The collecting official shall then endorse the new tag number on the license and shall keep a record in the file.

6.06.060 Collecting Officials. The City Clerk and deputy City Clerk are the officials to collect the tax and issue cat licenses. In addition, any veterinarian and any humane society shall be collecting officials, upon the request of any such veterinarian or humane society, who shall then collect the tax and issue cat licenses. (Ord 537, 2003)

CHAPTER 6.08

DANGEROUS DOGS

Chapters:

- 6.08.010 Definitions.
- 6.08.020 Exemptions.
- 6.08.030 Determination Hearing.
- 6.08.040 Actions Required by Owner of Dangerous Dogs.
- 6.08.050 Euthanasia Option.
- 6.08.060 Penalties.

6.08.010 Definitions. For the purpose of this chapter, except as otherwise indicated, the following definitions will apply:

- A. "Dangerous Dog" means:
 - 1. Any individual dog that when unprovoked inflicts bites or attacks a human being or other animal either on public or private property;
 - 2. Any individual dog with a known propensity, tendency, or disposition to attack without provocation, to cause injury or to otherwise endanger the safety of human beings or domestic animals;
 - 3. Any individual dog which attacks a human being or domestic animal without provocation; or
 - 4. Any individual dog which has been found to be a "potentially dangerous dog" upon three (3) separate occasions.
- B. "Potentially Dangerous Dog" means any animal:
 - 1. The behavior of which constitutes a physical threat of bodily harm to a person in a place where such person is conducting himself or herself peacefully or lawfully;

2. Which chases or approaches a person upon a street, sidewalk or any public grounds in a menacing fashion or apparent attitude of attack;

3. Which, on three (3) separate occasions within a six (6) month period has been observed by law enforcement personnel or their authorized agent to be unrestrained or uncontrolled off its owner's premises or has been impounded for being unrestrained or uncontrolled of its owner's premises.

C. "Enclosure" means a fence or structure of at least 6 feet in height, and no more than 15 feet by 8 feet in area, forming or creating an enclosure suitable to prevent the entry of young children, and suitable to confine a dangerous dog. Such enclosure shall be securely enclosed and locked and designed with secure sides, top and bottom, and shall be designed to prevent the animal from escaping from the enclosure. If said fence or structure does not have a bottom that is secured to the sides, the sides shall be embedded in the ground. Such enclosure shall be within an area fenced by a fence 6 feet in height, and all gates within said fence shall remain locked at all times.

6.08.020 Exemptions. No dog shall be deemed "dangerous" if it bites, attacks or menaces a trespasser on the property of its owner or harms or menaces anyone who has tormented or abused it or is a professionally trained dog for law enforcement.

6.08.030 Determination Hearing. A Determination Hearing shall be conducted by law enforcement whenever there is cause to believe that an animal may be a dangerous animal as defined in this chapter. Said hearing shall be conducted within seven (7) days of serving notice to the owner by certified letter. Pending the outcome of such a hearing, the animal must be securely confined in a humane manner either on the premises of the owner, with a licensed veterinarian, or approved facility. Law enforcement shall determine whether to declare the animal to be a "dangerous" animal based upon evidence and testimony presented at the time of the hearing by the owner, witnesses to any incidents which may be considered germane to the determination, health department personnel, animal control personnel, police or any other person possessing information pertinent to such determinations. Law enforcement shall issue written findings within five (5) days after the Determination Hearing. The owner or possessor of the animal found to be dangerous by this hearing has the right to appeal the decision within ten (10) days of receiving such decision, by written notice of appeal filed with the Chief of Police, who shall review the record of the determination hearing and render a written decision within twenty (20) days of the filing of the appeal.

6.08.040 Actions Required by Owner of Dangerous Dogs

(a) The owner shall post signage at the front and rear property lines of the premises on which said animal is kept, which signage reads as follows: BEWARE OF VICIOUS DOG.

(b) The owner shall notify law enforcement authorities within 24 hours if the animal is loose, unconfined, has attacked another animal, or has attacked a human being, or has been removed from the City, or has died.

(c) The owner must provide proof that the animal has been neutered.

(d) The owner must keep the dog at all times in a secure enclosure except as otherwise provided herein. The dog may only be allowed out of the enclosure when it is necessary to obtain veterinary care or to comply with court orders.

(e) If it is necessary for the dog to leave the enclosure, the dog must be securely muzzled and restrained with a leash having a tensile strength of 300 pounds and not exceeding 3 feet, and shall be under the direct control and supervision of the owner.

(f) The owner shall allow law enforcement to inspect the premises in which the dangerous dog is kept, without prior notification to the owner. This inspection is to determine if the enclosure is secure, that facilities exist to adequately feed, house, and maintain the animal, and that the location of the enclosure is not likely to endanger the safety of persons in the vicinity of the location.

6.08.050 Euthanasia Option.

(a) If the owner of a dangerous dog is unwilling or unable to comply with this chapter, then the owner shall have the animal humanely euthanized by a licensed veterinarian.

(b) Law Enforcement personnel or their authorized agent may, in order to protect the health, welfare, and safety of the City's residents, order that a dangerous dog be humanely euthanized.

6.08.060 Penalties. Any person who violates this ordinance shall be required to forfeit not less than \$200.00 nor more than \$1,000.00 and the costs of prosecution and upon failure to pay shall be confined in the County Jail until such forfeiture and costs are paid, not exceeding 30 days. Each day a violation continues constitutes a separate offense. A dangerous dog running at large constitutes a public nuisance and the owner thereof may be proceeded against for maintaining a public nuisance.

CHAPTER 6.09

OWNING, KEEPING OR HARBORING CHICKENSSections:

- 6.09.010 Definitions.
- 6.09.020 Licensing Requirements.
- 6.09.030 Use Conditions.
- 6.09.040 Structures.
- 6.09.050 Setbacks.
- 6.09.060 Public Health and Safety Concerns.
- 6.09.070 Complaints.
- 6.09.080 Penalty.

6.09.010 Definitions.

A. Chicken Run or Pen. A fenced or other type of enclosure that is mostly open to the elements, for the purpose of allowing chickens to leave the henhouse or coop while remaining in a predator-safe environment.

B. Henhouse or Chicken Coop. A structure providing shelter for chickens which is completely enclosed.

6.09.020 Licensing Requirements.

A. Any person who owns, keeps or harbors chickens in the City of Viroqua shall obtain a license within thirty (30) days of acquiring the chickens. Residents deciding to own, keep or harbor chickens for successive years do not need to obtain a new license but must pay an annual renewal fee of \$25 for each term year they own, keep or harbor such chickens. The term year of a license commences on January 1 and ends the following December 31.

B. Applicants who don't own the subject property must receive written approval from the owner of the property prior to submission of the application. This paragraph only applies to new license applications.

C. Applicants residing in a two-family dwelling must receive written approval from the other occupant(s) of the two-family dwelling prior to submission of the application. This paragraph only applies to new license applications.

D. A written waste removal and disposal plan shall be submitted with all license applications.

E. Applications must be approved by City Administration. If City Administration denies an application, the applicant may appeal the decision to the City Council. Any such appeal shall be decided by a majority vote of the City Council.

F. Applications shall be made to the City Clerk and the fee for license shall be \$25.

G. If an investigation by the City or its agents reveals that the owner or occupier of the property owns, keeps or harbors chickens in violation of this section or any other section of the Municipal Code, the City shall have authority to require the owner or occupier of the property to fix, abate or alleviate the problem. If the problem is not satisfactorily abated or alleviated within one week of service of an order to abate, the City of Viroqua shall have the authority to revoke the license.

6.09.030 Use Conditions. Any owner, occupier, or user of the property within the City of Viroqua who chooses to own, keep or harbor chickens shall be limited to the following conditions:

A. One property is limited to owning, keeping or harboring up to six (6) chickens. In a two-family dwelling each unit may own, keep or harbor up to six (6) chickens.

B. A person may only own, keep or harbor chickens on property being used as a one-family dwelling or two-family dwelling in areas zoned R-1 or R-2 as defined in Section 17.08.010.

C. No person shall keep any rooster.

D. The chickens shall be provided with a covered enclosure and must be kept in the covered enclosure or a fenced enclosure within the backyard of the property at all times.

E. Noise shall not be perceptible at the lot lines to the extent it results in a public nuisance. It shall be unlawful for any person, firm, corporation or entity operating, having charge of, or occupying any building to own, keep, harbor or allow to be kept any chicken which shall habitually by any noise disturb the peace and quiet of any person in the vicinity thereof.

6.09.040 Structures.

A. Enclosed and Predator Resistant Structure. Chicken runs, pens, henhouses and coops shall be enclosed and constructed of durable materials to prevent entry by predators or the escape of chickens. All walls, ceiling and roof areas shall also be protected against entry by predators.

B. Construction Materials. Chicken runs, pens, henhouses and coops shall be constructed of weather-resistant materials that can readily be cleaned, maintained and kept in good appearance.

C. Elevation of Structures. Henhouses and coops shall be elevated at least eighteen (18) inches above grade, with an elevated floor that will prevent entry by rodents, pests and predators.

D. Minimum Area per Chicken in Henhouse or Coop. The henhouse or coop shall provide not less than four (4) square feet of area per chicken.

E. Minimum Area per Chicken in Run or Pen. A chicken run or pen shall be provided and be large enough to allow freedom of movement, but shall provide not less than four (4) square feet of area per chicken.

F. Feed and Water Required. Adequate feed and water shall be continuously provided in such a manner to provide protection against freezing. Food shall be stored in an enclosed container to prevent rodents or other pests from gaining access thereto or coming into contact therewith.

6.09.050 Setbacks.

A. Chicken runs, pens, henhouses and coops shall be set back from all adjacent residences not occupied by the applicant by not less than twenty-five (25) feet and not less than fifteen (15) feet from any lot line.

B. Chicken henhouses and coops shall be set back not less than twenty (20) feet from the applicant's residence.

C. All structures relating to chickens shall be located in the rear yard of the residence.

D. No facility for storing manure or feed shall be located within one hundred (100) feet of any adjacent residence not occupied by the applicant and not less than fifty (50) feet from any lot line.

6.09.060 Public Health and Safety Concerns.

A. No person shall keep any chicken within the City of Viroqua in any unsanitary condition or within such proximity of dwelling houses or in any manner so as to be a nuisance.

B. All chicken pens, runs, henhouses and coops shall be kept in a clean, sanitary condition and free from all objectionable odors. Odors shall not be perceptible at lot lines. Conditions that cause odor to be perceptible at the lot lines shall be deemed a public nuisance.

C. The City of Viroqua and their agents shall have jurisdiction to inspect the premises upon which chickens are kept and ascertain and determine whether the conditions are unsanitary or if for any reason a nuisance is caused thereby.

D. If the City of Viroqua or its agents determine that conditions are unsanitary, or if for any reason a nuisance exists, they shall have authority to order the owner or occupant of the premises to abate the nuisance and it shall thereupon be unlawful to keep chickens on the premises. If the nuisance is not satisfactorily abated or alleviated within one week of service of an order to abate, the City of Viroqua may take action to abate the nuisance. The cost of abatement shall be assessed against the property as a special tax or charge.

E. No person shall compost chicken manure in violation of Section 8.22.50 of the Viroqua Municipal Code.

6.09.070 Complaints. A complaint against any person owning, keeping or harboring chickens in accordance with this section may be filed with the City Clerk or the Viroqua Police Department.

6.09.080 Penalty. Any person who violates this ordinance shall be required to forfeit not less than \$25 nor more than \$200 for each violation, together with costs of prosecution. Each day a violation occurs shall constitute a separate offense. Any chicken run, pen, henhouse or coop maintained in violation of this ordinance is hereby declared to be a public nuisance.

Chapter 6.12CRUELTY TO ANIMALSSections:

6.12.010 Prohibited acts – Penalty.

6.12.010 Prohibited acts – Penalty. Any person who willfully, maliciously or wantonly kills, maims, mutilates, disfigures or injures any horse, mule, cattle, sheep, dog or other domestic animal of another, except in cases expressly authorized by some law of the state; or who administers poison to any such animal or exposes any poison with the intent that the same may be taken or swallowed by any such animal; or who overdrives, overloads, maims, wounds, tortures, torments cruelly, beats or kills any such animal belonging to himself or another, or, being the owner or having the care or charge thereof, fails to provide necessary food, water or shelter for any such animal; or who turns out and abandons, without proper care and protection, or cruelly works any such animal of which he is the owner or has the care or charge, when such animal is old, disabled or unfit for work; or who carries or confines any live animal, fowl or bird in a cruel or inhumane manner or who causes, procures or abets any cruelty mentioned in this section or the fighting or baiting of dogs or cocks, shall be punished by a fine. (Ord. 281 §4, 1977; Ord. 4 §1, 1904).

Title 7

(RESERVED)

Title 8HEALTH AND SAFETYChapters:

- 8.08 Explosives
- 8.10 Open Burning
- 8.11 Solid Fuel Burning Devices
- 8.12 Fireworks
- 8.14 Smoking Regulated
- 8.18 Regulation of Solid Waste
- 8.28 Property Maintenance
- 8.32 Noxious Weeds and Regulation of Length of Turf Grasses
- 8.36 Trees and Shrubs

Chapter 8.08EXPLOSIVESSections:

- 8.08.010 Storage of certain items prohibited - Use regulated
- 8.08.020 Gunpowder and blasting caps - storage, use
- 8.08.030 Gunpowder - permit to sell or store
- 8.08.040 Violation - Penalty

8.08.010 Storage of certain items prohibited - Use regulated. No person shall store or keep any dynamite, nitroglycerine or other explosives, other than gunpowder, on any premises within the city. No person shall detonate any dynamite without a license as hereinafter provided. An application for a license shall be made in writing, stating the date, time, and place dynamite is to be detonated, and describing the area in which residents may be affected by such detonation, and that the applicant has notified, or will notify, such residents of the date, time, and place of detonation, prior to any detonation. The application shall be accompanied by proof of the applicant's having liability insurance in an amount not less than twenty thousand dollars per person and one hundred thousand dollars per incident, personal injury and property damage, and a certified check made payable to the city in the sum of two hundred dollars as security that the applicant has, or will have, notified residents as set forth in the application. The city clerk shall issue a license to an applicant complying with this section, In the event that any resident within the area described in the application shall complain to the city, within one week after detonation of any dynamite that such resident was not notified of such detonation, the said security of two hundred dollars shall be forfeited to the city, unless the applicant shows that it was not reasonable to notify said resident. If no such complaint is made, such security shall be returned to the applicant. (Ord. 333, 1982).

8.08.020 Gunpowder and blasting caps – storage or keeping restrictions. It is unlawful to store or keep any explosive in excess of one pound in any storeroom, wareroom, building or any premises within the city; provided , that metal canisters in a storeroom or wareroom away from artificial heat or light, and that no more than fifty pounds of gunpowder may be kept, if in a magazine made of fireproof material or of wood covered with sheet iron and mounted on wheels and kept securely locked except when necessarily opened for use by authorized persons, and not more than one thousand blasting caps in a similar but separate magazine. Said magazines shall be conspicuously labeled, in red letters at least four inches high, "EXPLOSIVES," and shall be located within the building on the floor nearest the street level and within ten feet of the street entrance. (Ord. 48, 1921).

8.08.030 Gunpowder – Permit to sell or store. Any person, firm or corporation who sells or stores gunpowder shall obtain a permit from the chief of the fire department, who shall inspect the place where the same is kept, and the dealer shall fully disclose to said chief where the same is kept both day or night. (Ord. 48, 1921).

8.08.040 Violation – Penalty. Any person who violates any provision of this chapter shall be required to forfeit not less than one hundred dollars nor more than five hundred dollars, together with the costs of prosecution, and in default of payment, shall be committed to the county jail until such forfeiture and costs are paid, not exceeding thirty days. Each day of any violation shall constitute a separate offense. (Ord. 333, 1982).

Chapter 8.10

OPEN BURNING

Sections:

- 8.10.010 "Open Burning" defined.
- 8.10.020 Open Burning prohibited; exceptions
- 8.10.030 Certain Open Burning allowed with Permit
- 8.10.040 "Burn Barrels" expressly prohibited
- 8.10.045 Burning of waste and recyclables prohibited
- 8.10.050 Penalty

8.10.010 "Open Burning" defined . "Open Burning" means kindling or maintaining any fire outside of any residence or other building.

8.10.020 Open Burning prohibited; exceptions. No person shall kindle or maintain any open burning except the following:

- (A) Outdoor cooking in a grill or other device manufactured for such purpose;
- (B) Training for fire department personnel;
- (C) Occasional campfire, or bonfire, on the following conditions only: no material may be burned other than untreated wood; the campfire or bonfire burn site shall be no larger than 3 feet by 3 feet; the fire shall be constantly attended by a competent person; no fire later than 12 o'clock midnight; no fire shall be kindled or allowed to continue when the fire chief or the chief's designee determines that the fire poses a risk of spreading beyond control, or because of weather or atmospheric conditions constitutes a nuisance; the owner of property where such campfire or bonfire is kindled is strictly liable for damage to property and injury to person, and for the costs and expenses of the fire department response to any emergency, of which the fire is a cause.

8.10.030 Certain Open Burning allowed with Permit. The fire chief or the chief's designee may permit other open burning (such as, larger bonfires, or the burning of brush) on such conditions as the chief or the chief's designee may determine are consistent with this ordinance, but may not permit what is prohibited by this ordinance

8.10.040 "Burn Barrels" expressly prohibited. No person shall burn anything in any barrel ("burn barrel"); this shall not be construed to prohibit outdoor cooking as permitted in this ordinance.

8.10.045 Burning of waste and recyclables prohibited. Burning of waste and/or recyclables, whether in an open pit, burn barrel or household incinerator is unhealthy, unneighborly, unnecessary, illegal and is prohibited.

8.10.050 Penalty. Any person who violates this ordinance shall be required to forfeit not less than \$100 nor more than \$200, together with the costs of prosecution, and in default of payment of such forfeiture and costs shall be imprisoned in the County jail until such forfeiture and costs are paid, not exceeding 30 days.

Chapter 8.11

SOLID FUEL BURNING DEVICES

Sections:

- 8.11.010 Definitions
- 8.11.020 Prohibited burning
- 8.11.030 Penalty

August 2013 revision

8.11.010 Definitions: (A) "Dry wood" means wood with a moisture content of less than 20 percent.

(B) "Solid fuel burning device" means every thing which uses wood or matter other than gas, liquid, or charcoal, for combustion, including stoves, fire places, hydronic heaters, and water boilers.

8.11.020 Prohibited burning: (A) From and after the effective date of this ordinance no person shall install a solid fuel burning device that is not certified by the United States Environmental Protection Agency, and then only if the chimney extends at least two feet above the highest peak of any residence within 500 feet.

(B) No person shall burn any thing in a solid fuel burning device except dry wood that has no paint, stains or other coating, and that has not been treated with preservatives or chemicals, including but not limited to copper, chromium arsenate, creosote or pentachlorophenol.

(C) No person shall cause or allow emission of a visible smoke plume from any solid fuel burning device for six consecutive minutes in any one hour period.

8.11.030 Penalty: (A) A person who violates this ordinance after having been given a written warning shall be required to forfeit not less than \$50 nor more than \$100 and upon failure to pay such forfeiture and costs of prosecution shall be sentenced to the County jail not exceeding 30 days. Each day a violation occurs is a separate offense.

(B) Repeated violations of this ordinance constitutes a public nuisance. (ORD 13OR004; ORD 08OR003; ORD 04OR006)

Chapter 8.12

FIREWORKS

Sections:

- 8.12.010 Definitions.
- 8.12.020 Permit required.
- 8.12.030 Permit, to whom issued.
- 8.12.040 Indemnity.
- 8.12.050 Penalty.

8.12.010 Fireworks, defined. "Fireworks" has the meaning in Section 167.10, Wis. Stats. (Ord. 436, 1992).

8.12.020 Permit required. No person may possess or use fireworks without a permit granted by the Common Council and issued by the City Clerk. (Ord. 436, 1992).

8.12.030 Permit, to whom issued. A permit may be issued to the following:

- A public authority.
- A fair association.
- An amusement park.
- A park board.
- A civic organization.
- A group of resident or nonresident individuals.
- An agricultural producer for the protection of crops from predatory birds or animals. (Ord. 436, 1992)

8.12.040 Indemnity. No permit may be issued until the applicant files with the City Clerk an indemnity bond or policy of liability insurance for the payment of all claims that may arise by reason of injuries to person or property from the handling, use or discharge of fireworks under the permit. (Ord. 436, 1992).

8.12.050 Penalty. Any person who violates this chapter shall be required to forfeit not less than \$100 nor more than \$500, together with the costs of prosecution, and in default of payment shall be imprisoned in the county jail until such forfeiture and costs are paid, not exceeding 30 days. (Ord. 436, 1992).

8.12.050 Penalty. Any person who violates this chapter shall be required to forfeit not less than \$100 nor more than \$500, together with the costs of prosecution, and in default of payment shall be imprisoned in the county jail until such forfeiture and costs are paid, not exceeding 30 days. (Ord. 436, 1992).

Chapter 8.14

SMOKING REGULATED

Sections:

8.14.010	Definitions.
8.14.020	Prohibition against smoking generally
8.14.030	Prohibition at child care center
8.14.040	Prohibition at certain public facilities
8.14.050	Responsibility of persons in charge
8.14.060	Exceptions
8.14.070	Outside smoking areas may be designated
8.14.080	Penalties

8.14.010 Definitions. In this chapter:

(ab) "Assisted living facility" means a community-based residential facility, as defined in s. 50.01(1g), a residential care apartment complex, as defined in [s. 50.01\(1d\)](#), or an adult family home, as defined in s. 50.01(1)(b).

(abm) "Child care center" has the meaning given in s. 49.136(1) (ad).

(ae) "Educational facility" means any building used principally for educational purposes in which a school is located or a course of instruction or training program is offered that has been approved or licensed by a state agency or board.

(aj) Notwithstanding s. 101.01(5), "employment" means any trade, occupation, or process of manufacture or any method of carrying on such trade, occupation, or process of manufacture in which any person may be engaged.

(ak) "Enclosed place" means a structure or area that has all of the following: a roof and more than 2 substantial walls; "substantial wall" means a wall with no opening or with an opening that either does not allow air in from the outside or is less than 25 percent of the wall's surface area. (12OR002)

August 2012 revision

(b) "Inpatient health care facility" means a hospital, as defined in s. 50.33(2), a county home established under s. 49.70, a county infirmary established under s. 49.72, a nursing home, as defined in s. 50.01(3), a hospice, as defined in s. 50.90(1), a Wisconsin veterans home under s. 45.50, or a treatment facility.

(bn) "Lodging establishment" means any of the following:

1. A bed and breakfast establishment, as defined in s. 254.61(1).
2. A hotel, as defined in s. 254.61(3).
3. A tourist rooming house, as defined in s. 254.61(6).

(d) "Person in charge" means the person, or his or her agent, who ultimately controls, governs or directs the activities aboard a public conveyance or at a location where smoking is prohibited or regulated under this section.

(dj) Notwithstanding s. 101.01(11), "place of employment" means any enclosed place that employees normally frequent during the course of employment, including an office, a work area, an elevator, an employee lounge, a restroom, a conference room, a meeting room, a classroom, a hallway, a stairway, a lobby, a common area, a vehicle, or an employee cafeteria.

(dn) "Private club" means a facility used by an organization that limits its membership and is organized for a recreational, fraternal, social, patriotic, political, benevolent, or athletic purpose.

(e) "Public conveyance" means a mass transit vehicle as defined in s. 340.01(28m), a school bus as defined in s. 340.01(56), or any other device by which persons are transported, for hire, on a highway or by rail, water, air, or guidewire within this state, but does not include such a device while providing transportation in interstate commerce.

(eg) "Public place" means any enclosed place that is open to the public, regardless of whether a fee is charged or a place to which the public has lawful access or may be invited.

(f) "Restaurant" means an establishment as defined in s. 254.61(5).

(g) "Retail establishment" means any store or shop in which retail sales is the principal business conducted.

(gg) "Retail tobacco store" means a retail establishment that does not have a "Class B" intoxicating liquor license or a Class "B" fermented malt beverages license and that generates 75 percent or more of its gross annual income from the retail sale of tobacco products and accessories.

(h) "Smoking" means burning or holding, or inhaling or exhaling smoke from, any of the following items containing tobacco:

1. A lighted cigar.
2. A lighted cigarette.
3. A lighted pipe.
4. Any other lighted smoking equipment.

(hm) "Sports arena" means any stadium, pavilion, gymnasium, swimming pool, skating rink, bowling center, or other building where spectator sporting events are held.

(im) "Tavern" means an establishment, other than a restaurant, that holds a "Class B" intoxicating liquor license or Class "B" fermented malt beverages license.

(io) "Tobacco product" means any form of tobacco prepared in a manner suitable for smoking but not including a cigarette.

(ip) "Treatment facility" means a publicly or privately operated inpatient facility that provides treatment of alcoholic, drug dependent, mentally ill, or developmentally disabled persons.

(j) "Type 1 juvenile correctional facility" has the meaning given in s. 938.02(19).

8.14.020 Prohibition against smoking. Except as provided in section 8.14.060, no person may smoke in any of the following enclosed places:

- 1r. Child care centers.
2. Educational facilities.
3. Inpatient health care facilities.
4. Theaters.
7. Restaurants.
- 7m. Taverns.
- 7r. Private clubs.
8. Retail establishments.

8d. Common areas of multiple-unit residential properties.

8g. Lodging establishments.

8r. State, county, city, village, or town buildings.

9. All enclosed places that are places of employment or that are public places.

8.14.030 No person may smoke anywhere on the premises of a child care center when children who are receiving child care services are present.

8.14.040 No person may smoke in any of the following:

1. A sports arena.

2. A bus shelter.

3. A public conveyance.

8.14.050 Responsibility of persons in charge. (a) No person in charge may allow any person to smoke in violation of this chapter at a location that is under the control or direction of the person in charge.

(b) A person in charge may not provide matches, ashtrays, or other equipment for smoking at the location where smoking is prohibited.

(c) A person in charge shall make reasonable efforts to prohibit persons from smoking at a location where smoking is prohibited by doing all of the following:

1. Posting signs setting forth the prohibition and providing other appropriate notification and information concerning the prohibition.

2. Refusing to serve a person, if the person is smoking in a restaurant, tavern, or private club.

3. Asking a person who is smoking to refrain from smoking and, if the person refuses to do so, asking the person to leave the location.

(d) If a person refuses to leave a location after being requested to do so as provided in par. (c)3., the person in charge shall immediately notify an appropriate law enforcement agency of the violation.

(e) A person in charge may take measures in addition to those listed in pars. (b) and (c) to prevent persons from being exposed to others who are smoking or to further ensure compliance with this section.

8.14.060 Exceptions. The prohibition against smoking does not apply to the following:

(h) A private residence.

(i) A room used by only one person in an assisted living facility as his or her residence.

(j) A room in an assisted living facility in which 2 or more persons reside if every person who lives in that room smokes and each of those persons has made a written request to the person in charge of the assisted living facility to be placed in a room where smoking is allowed.

8.14.070 The person in charge of a restaurant, tavern, private club, or retail establishment located in an area subject to the ordinance may designate an outside area that is a reasonable distance from any entrance to the restaurant, tavern, private club, or retail establishment where customers, employees, or persons associated with the restaurant, tavern, private club, or retail establishment may smoke.

8.14.080 Penalties. Any person who violates this chapter shall be subject to a forfeiture of not less than \$100 nor more than \$250. (Ord 10OR006)

Chapter 8.18REGULATION OF SOLID WASTESections:

<u>8.18.010</u>	<u>Definition</u>
<u>8.18.020</u>	<u>Regulation of Solid Waste</u>
<u>8.18.030</u>	<u>Surcharges</u>
<u>8.18.040</u>	<u>Charges for City removal</u>
<u>8.18.050</u>	<u>Penalty</u>

8.18.010 Definition. "Solid waste" has the meaning described in State statute, presently section 289.01(33), Wis. Stats. (Ord 11OR005)

8.18.020 Regulation of disposition of solid waste. No person shall dispose of solid waste in any manner except: (a) to a licensed solid waste transporter in accordance with a schedule promulgated by such transporter; or (b) to a licensed solid waste facility.

8.18.030 Surcharges. A. Beginning January 1, 2009, a monthly charge shall be assessed to all property as a solid waste and recycling surcharge. The following are the initial rates and may be changed hereafter by resolution or motion adopted by the Council and reflected in the minutes of the meeting (Ord 09OR005; Ord 09OR001):

<u>Class:</u>	<u>Monthly surcharge:</u>
Industrial recycling:	\$5.30
Public recycling:	\$5.30
Commercial recycling:	\$5.30
Residential recycling and solid waste:	\$8.70

B The charges may be billed by statement on the monthly sewer and water statements, or other method as determined by the Public Works Committee or Council. Delinquent charges may be assessed against the property as a special charge in accordance with section 66.0627, Wisconsin Statutes. A charge is delinquent if not paid within 20 days after the end of the month when it is due.

C The City may allocate from the surcharge collected the following percentages, which may be changed hereafter: 5% for Municipal Utilities; 3.95% for legal and accounting. (Ord 08OR015; Ord 09OR001)

November 2011 revision

8.18.040 Charges for City removal. A. The City may remove solid waste from private property when disposed of contrary to City ordinance or state law, and charge the real estate served in the following manner, as authorized by section 66.0627, Wis. Stats. The City Administrator, or Director of Public Works, or the designee of either, or any police officer, alderman, or alderwoman, may give written notice of this section by first class mail to an owner of the property upon which the solid waste is placed, which shall constitute notice that if the solid waste is not lawfully disposed of within 1 week following the date of mailing the notice, that the City may remove the same and charge the cost thereof to the property owner which, if not paid within 30 days, shall be delinquent. A delinquent charge becomes a lien on the property served as of the date of delinquency. The delinquent special charge shall be included in the current or next tax roll for collection and settlement under ch. 74, Wis. Stats.

B. If the solid waste is not lawfully disposed of within 1 week of notice, the person mailing the notice shall furnish a copy to the Director of Public Works who shall arrange for removal of the solid waste, by City workers or by contract, and mail the property owner a notice of the cost of the work, with a copy of the notice to the City Clerk -Treasurer who shall, if such cost is not paid within such 30 days, include the cost in the current or next tax roll for collection and settlement under ch. 74, Wis. Stats.

8.18.050 Penalty. Any person who violates any provision of this chapter shall be required to forfeit not less than \$50 nor more than \$200 together with the cost of prosecution, and in default of payment shall be imprisoned in the county jail until such forfeiture and costs are paid, not exceeding 30 days. Each day a violation of this chapter continues shall constitute a separate offense. A continued violation of this chapter constitutes a public nuisance. (Ord 11OR005)

Chapter 8.22COMPOSTINGSections:

8.22.010	Purpose and Intent
8.22.020	Definitions
8.22.030	Location
8.22.040	Maintenance
8.22.050	Ingredients
8.22.060	Owner Responsibility
8.22.070	Penalty

8.22.010 Purpose and Intent. The purpose of this section is to promote the recycling of organic wastes through composting, and to establish minimum standards for proper compost maintenance.

8.22.020 Definitions.

- A. "Composting" shall mean a controlled biological reduction of organic wastes to humus.
- B. "Yard waste" shall mean leaves, grass clippings, garden debris and brush.

8.22.030 Location.

- A. Compost bins are only allowed in R1 and R2 Districts on property upon which an occupied single-family residence is located.
- B. Compost bins shall not be placed in any yard except a rear yard and shall be placed no less than 20 feet from any habitable structure off the subject property and no less than 10 feet from a property line or any structure on the subject property.

8.22.040 Maintenance. All compost bins shall be maintained using approved composting procedures to comply with the following requirements.

- A. All compost shall be enclosed in a freestanding compost bin. Total volume of all compost bins shall not exceed a volume more than one hundred twenty-five (125) cubic feet. No compost bin shall be taller than five (5) feet.

B. All compost bins shall be so maintained as to prevent the attraction or harborage of rodents and pests.

C. All compost bins shall be so maintained as to prevent unpleasant odors. Compost bins shall be kept covered except when turning.

8.22.050 Ingredients.

A. No compost bin shall contain any of the following:

1. Fish, meat or other animal products;
2. Cooked food scraps, except coffee grounds and tea leaves;
3. Animal waste; or
4. Large items that will impede the composting process.

B. Permitted ingredients shall include:

1. Yard waste;
2. Vegetable and fruit scraps that are suitable for composting; and
3. Commercial compost additives.

8.22.060 Owner Responsibility. Every owner or operator shall be responsible for maintaining all property under his or her control in accordance with the requirements of this subsection.

8.22.070 Penalty. Any person who violates this ordinance shall be required to forfeit not less than \$25 nor more than \$200 for each violation, together with costs of prosecution, and in default of payment thereof shall be imprisoned in the County jail until such forfeiture costs are paid, not exceeding 30 days. Each day a violation occurs shall constitute a separate offense. Any compost bin maintained in violation of this ordinance is hereby declared to be a public nuisance.

Chapter 8.28PROPERTY MAINTENANCESections:

- 8.28.010 Declared nuisance when.
 8.28.020 Property maintenance.
 8.28.030 Penalty.

8.28.010 Declared nuisance when. Storage within the City of old, unused, stripped, junked, unlicensed and other motor vehicles not in condition for normal use or in good and safe operation condition, and of any other vehicles, machinery, implements and/or equipment and personal property of any kind which is no longer usable for the purpose for which it was manufactured, which are collectively described in this chapter as "Said personalty", for a period of five days or more (except in licensed salvage yard), is declared to be a nuisance and dangerous to the public safety. (Ord. 223 §1, 1967).

8.28.020 Property maintenance. The purpose of this section is to secure the private and public benefits resulting from the safe, sanitary and attractive maintenance of residential and nonresidential buildings, structures, yards and vacant areas. Attractive and well-maintained property will maintain and increase property and esthetic values and enhance health and safety.

Every owner and occupier shall improve and maintain all property under his, her, or its control in compliance with the following minimum requirements.

Yards shall be properly graded to divert water away from buildings. Adjacent ground surface shall be sloped away from the structure with a grading of at least one-half (1/2) inch per foot for a minimum of five (5') feet where possible or by other means such as eaves, troughs, and downspout extensions.

Every foundation, floor, wall and roof shall be reasonably weathertight, watertight, rodentproof, capable of affording privacy, and shall be kept in proper repair. Any sagging or bulging shall be properly repaired to a level or plumb position.

Exterior surfaces of buildings and structures that are not inherently resistant to deterioration shall be periodically treated with a protective coating of paint or other suitable preservative which will provide adequate resistance to weathering.

Every window, exterior door, and exterior basement entrance shall be reasonably weathertight, watertight, and rodentproof, and shall be kept in proper working condition and repair.

Every window, door, other openings, plumbing and heating fixture or appurtenance of every building shall be so maintained as to prevent such building from deterioration or dilapidation or blight which causes such building to offend the aesthetic character of the immediate neighborhood.

Every exterior stair, porch, railing, and related accessory shall be constructed and maintained to be safe to use and capable of supporting the load that normal use may place on it.

All chimneys and breeching shall be so constructed and maintained so as to insure that safe removal of products of combustion from the building.

Equipment required by the City Code, water and sewer pipes, and other utility systems, shall be maintained in proper working condition, free from defects, leaks, and obstructions.

Fences and other structures, sidewalks, walks, drives, and other concrete, asphalt, brick, graveled, stone or similarly improved yard areas, shall be kept in sound condition and good repair. Conditions resulting in dust, dirt, loose stones or other aggregate being repeatedly deposited on adjacent public or private property shall not be permitted.

Yards shall be maintained in a clean and sanitary condition.

No person shall store or allow to remain on property owned or occupied by such person, outside of any building or structure, any of the following things: unlicensed or unregistered motor vehicles; junk or discarded property or materials; appliances including refrigerators; furniture; furnaces; wood not intended for heating or construction purposes; bricks, cement blocks, and similar building materials not used within a reasonable time for the purpose for which they were made; scrap iron, steel, or other metal, not used within a reasonable time for the purpose for which they were made; machinery or machinery parts; tires, wheels, or rubber not being used for the purpose for which made; rubbish or garbage not in authorized containers; any personal property or condition presenting a physical hazard, or a place of rodent harborage or insect infestation; any other personal property which was designed to be used within a structure but which is stored outside for more than 30 days; any other article which from its worn condition renders it practically useless for the purpose for which it was made, or which the owner thereof in fact has no intention of using for such purpose.

Firewood may be stored in the rear yard of the property. The firewood must be cut to lengths of less than four (4) feet and less than two (2) feet in diameter.

8.28.030 Penalty. Any person who violates this ordinance shall be required to forfeit not less than \$25 nor more than \$200 for each violation, together with the costs of prosecution, and in default of payment thereof shall be imprisoned in the County jail until such forfeiture and costs are paid, not exceeding 30 days. Each day a violation continues shall constitute a separate offense. Any property on which a violation occurs is hereby declared to be a public nuisance.

Chapter 8.32

NOXIOUS WEEDS AND REGULATION OF LENGTH OF GRASS

Sections:

8.32.010	Public Nuisance Declared.
8.32.020	Weeds designated - Declared noxious.
8.32.030	Unlawful - Destruction required.
8.32.040	Failure to destroy - Penalty.
8.32.050	Abatement.
8.32.060	Failure to destroy - rates for City corrective action.

8.32.010 Public Nuisance Declared. Noxious weeds and grass which exceeds eight (8) inches in length as defined in this Chapter adversely affect property values and public health and safety and are hereby declared to be a public nuisance.

8.32.020 Weeds designated - Declared noxious. The following plants are declared noxious weeds:

A. Ambrosia artemisiifolia (common ragweed), Ambrosia trifida (giant ragweed), Cirsium vulgare (Bull thistle), Cirsium arvense (Canada thistle), Convolvulus arvensis (Field bindweed), Euphorbia esula (Leafy spurge), Toxicodendron radicans (Poison ivy), Toxicodendron diversilobum (Poison oak), Pastinaca sativa (Wild or Poison parsnip) and Conium maculatum (Poison hemlock).

B. Grass over 8 inches in height that is:

1. Located within 3 feet of any property line **or**
2. Located outside of an established landscaping bed. A landscaping bed is defined as an area of plantings clearly and intentionally delineated from the remainder of the property by a natural or manmade border.

8.32.030 Unlawful - Destruction required. No person shall permit any noxious weeds (as defined in section 8.32.020) upon land owned or occupied by said person, nor upon the boulevard or street right of way abutting said person's property; said person shall destroy said noxious weeds. (Ord 428, 1991).

8.32.040 Failure to destroy - Penalty. In the event such person fails to destroy noxious weeds, a citation may be issued for the ordinance violation. Said person shall be required to forfeit not less than \$50 nor more than \$200 for each offense, each day a violation continues being a separate offense, and upon default in payment shall be imprisoned in the county jail until said forfeiture and any costs of prosecution are paid, not exceeding 30 days. (Ord 428, 1991)(Ord 17OR005).

8.32.050 Abatement. If the owner/occupant of the property does not contest the citation or is found guilty of the ordinance violation in municipal court and the property is not brought into compliance with this Chapter within forty-eight (48) hours of the municipal court's decision, the weed commissioner or other designated City employee shall destroy or cause such weeds to be destroyed, in the manner deemed to be the most economical method. If the owner/occupant of the property informs the City Clerk of his or her intent to appeal the municipal court decision before the expiration of the forty-eight (48) hours, the City will not take action to abate until either (1) the period to appeal has expired and no appeal has been filed, or (2) a decision is made on the appeal. The cost of abatement shall be assessed against the property (or in the case of boulevards or street rights of way, against the abutting property). An account showing the amount chargeable to each piece of land shall be filed with the City Clerk who, in turn, shall mail same to the owner and occupant of the premises. If the statement is not paid in full within thirty (30) days thereafter, the City Clerk may enter the charges in the tax role in a column headed "For the Destruction of Weeds" as a special tax against said lot or parcel of land. (Ord 17OR005).

8.32.060 Failure to destroy - rates for City corrective action. The Council shall from time to time by resolution establish rates for the use of City equipment and labor in destroying noxious weeds if any person fails to do so after notification as provided in Section 8.32.030. (Ord 238 §4, 1971).

Chapter 8.36

TREES AND SHRUBS

Sections:

8.36.010	Purpose
8.36.020	Definitions
8.36.030	Authority and Power
8.36.040	Applicability
8.36.050	Authority to Enter Private Premises
8.36.070	Tree Species and Sizes to be Planted
8.36.080	Spacing
8.36.090	Distance from Curb and Sidewalk
8.36.100	Distance from Fire hydrants
8.36.110	Utilities
8.36.120	Public Tree Care
8.36.130	Pruning-Corner Clearance
8.36.140	Dead or Diseased Tree Removal on Private Property
8.36.150	Tree Topping
8.36.155	Protection of Trees in Construction Areas
8.36.160	Sight Triangle
8.36.161	Seasonal pruning and removal of oak trees
8.36.162	Landscape plans
8.36.170	Permits Required
8.36.180	Penalty
8.36.190	Appeal

8.36.010 Purpose. Trees are a valuable resource which enhances the aesthetics of the community. They prevent soil erosion, filter airborne pollutants, reduce atmospheric carbon dioxide, produce oxygen and ameliorate harsh climates, thereby reducing energy consumption. In addition, trees contribute significantly to property values and provide many other benefits, both locally and globally.

It is the intention of this ordinance to promote the planting and maintenance of trees and shrubs on public and private lands.

This will be achieved with a minimum of danger or damage to persons, buildings, streets, curbs, sidewalks, overhead wires and all underground utilities. It is also the intent of this ordinance to guard against the spread of disease and to avoid damage to or the unnecessary removal of trees and shrubs on public and private lands. (Ord 06OR002)

8.36.020 Definitions. Whenever the following words or terms are used in this chapter, they shall be construed to have the following meanings:

- a) Person. Person, firm, association or corporation.
- b) Public Areas. Includes all public parks and other lands owned, controlled or leased by the City. (Ord 06OR002)
- c) Public Trees and Shrubs. All trees and shrubs located or to be planted in or upon public areas, which include boulevards, alley right of ways, parks, waterways and easements.
- d) Boulevard. That portion of the right-of-way lying between the normal location of the improved roadway and the boundary of the street right-of-way (the "lot line") shall be deemed to be the boulevard for the purpose of this chapter.
- e) [blank]
- f) Tree. Any woody plant, normally having one stem or trunk.
- g) Parks Commission. See Chapter 2.20, Board of Park Commissioners.
- h) Tree Board. Refer to 8.36.030 for composition and duties of Tree Board.
- i) Topping. The severe cutting back of limbs to stubs within a tree's crown to such a degree as to remove the normal canopy and disfigure the tree.
- j) Contractor. A person or company who is hired by the City to do work outlined by the City.
- k) Street Trees. Street trees are trees, shrubs, and woody vegetation that lie in street and/or alley right of way and on the boulevard.
- l) City Trees. City trees are Street Trees as defined above and trees, shrubs, and woody vegetation located in parks, on City owned property, on waterways and easements.
- m) Sight Triangle. A triangle formed by measuring 15 feet back in both directions from the intersection of two right-of-ways at the sidewalk, or if there are no sidewalks, from where the walks normally would be located.
- n) Hazard Tree. Any defective tree or tree part, that poses a high risk upon its failure or fracture to cause injury to people or damage to property.
- o) City Forester. The Council shall designate a City Forester or assign such duties to a City employee. Qualifications for the position shall include up to date knowledge of sound forestry practices in an urban environment. The forester shall attend regular workshops and conferences, as appropriate, commensurate with his or her background, education and knowledge.

8.36.030. Authority and Power.

1. The Council hereby creates the Tree Board which shall have control of all Street Trees and City Trees. This shall include planting, transplanting, removing, pruning, treating and otherwise caring for and protecting all trees, shrubs and plants on all public lands not specifically delegated to other City Boards, in order to preserve and enhance the beauty and general welfare of the community.

b. The Tree Board is empowered to require landowners to remove or prune specified trees, shrubs or plants deemed a safety hazard. The Tree Board may prohibit the planting of certain trees or tree species, shrubs, or plants on private lands within the City of Viroqua.

c. The Tree Board is empowered to require landowners to treat specified trees that have been infested by insects or are infected by a disease and will work with the landowner to ensure that this is done in a safe manner.

2. The City Tree Board shall consist of two Council members and five citizen members. One of the Council members shall be from a Council committee that oversees public works and one from a committee that oversees the city parks. If available, two of the five citizen members shall be individuals with training or expertise in the field of arboriculture or a related discipline. All citizen members shall possess a known interest in the value of trees in the urban environment. Citizen members shall be appointed by the mayor with the approval of the Council.

a. The term of the five citizen members shall be three years, except that the term of two of the members appointed to the first board shall be for one year, the next two will be two years, and the fifth will be for 3 years. In the event that a vacancy shall occur during the term of any one member, his/her successor shall be appointed for the unexpired portion of the term. A member may succeed him or her self.

b. The two Council members shall be appointed by the Mayor, subject to Council approval. This shall occur annually at such time as each new Council organizes itself after the spring election.

c. The tree board shall organize annually by appointing a chairperson. The tree board shall keep a record of its proceedings.

3. The city forester shall be subject to the direction and authorization of the tree board. (Ord 06OR002)

8.36.040. Applicability. This ordinance provides full power and authority over all trees, plants, and shrubs located within the boulevards and public places of the City and to trees, plants, shrubs located on private property that constitute a hazard or threat as described herein. Trees and Shrubs within city parks are the responsibility of the Board of Park Commissioners, Chapter 2.20. (Ord 06OR002)

8.36.050. Authority to Enter Private Premises. The City, its agents and employees, may enter upon private premises at all reasonable times for the purpose of examining any tree or shrub located upon or over such premises and carrying out any of the provisions of this chapter. If a request to inspect such trees or shrubs is denied by the person responsible for the property, an inspection warrant may be obtained pursuant to relevant Wisconsin Statutes. (Ord 06OR002)

8.36.070. Tree species and size to be planted. The City Tree Board shall develop and maintain a list of trees for planting as street trees. Only small (under 25 feet) and medium (25 to 45 feet) trees will be allowed to be planted as street trees except as otherwise permitted by the Tree Board. Any tree planted within areas defined in 8.36.020(l) under "City trees" becomes the property of the City. A permit is required to plant "City trees". (Ord 06OR002)

8.36.080. Spacing. The City Forester shall determine the spacing of City trees. (Ord 06OR002)

8.36.090. Distance from Curb and Sidewalk. The City Forester will determine the distance street trees may be planted from the curb and sidewalks. (Ord 06OR002)

8.36.100. Distance from Fire Hydrants. No street tree shall be planted within 10 feet of any fire hydrant. (Ord 06OR002)

8.36.110. Utilities. No street trees other than those listed as small trees may be planted under any overhead wire. (Ord 06OR002)

8.36.120 Public Tree Care. Whenever the City proposes the pruning, or removal of any tree, it shall give 2 weeks written notice to the owner of the abutting lot or parcel of land, and if there be a tenant occupying said property, then also to such tenant, of a time and place at which contemplated work will be considered by the City; specifying in detail the street or portion thereof, upon or from which trees are proposed to be planted, pruned or removed, and the general nature and character of the changes and improvements contemplated. This notice is not required for routine maintenance of City trees by the City or its agents. This chapter may be waived due to emergency conditions (determined by the Forester) or signed permission from the owner. Any tree deemed a hazard by the City Forester may be removed without notice. (Ord 06OR002)

8.36.130. Pruning - Corner Clearance. Private property owners of any tree overhanging any street or right of way within the City shall prune the branches so that such branches shall not severely obstruct the light from any street lamp or obstruct the view of any street intersection and so that there shall be a clear space of thirteen feet (13') above street surface or eight feet (8') above the sidewalk surface. Said owners shall remove all dead, or dangerous trees, or broken or decayed limbs which constitute a menace to the safety of the public. The City shall have the right to prune any tree or shrub on private property when it interferes with the proper spread of light, or interferes with visibility of any traffic control device or sign or sight triangle at intersections. A written notice will be given to the landowner, giving them two weeks to do the work

described above. Within that written notice the city shall provide materials describing proper pruning methods. If compliance is not made, the city will do the work and charge the cost thereof to the landowner or assess it to the property as a special charge. Tree limbs that grow near high voltage electrical conductors shall be maintained clear of such conductors by the electric utility company in compliance with any applicable franchise agreements. A utility tree pruning policy must be reviewed by the Tree Board and the City Forester prior to any pruning by the utility company. (Ord 06OR002)

8.36.140. Dead or Diseased Tree Removal on Private Property. The City shall have the right to remove any dead or diseased trees on private property within the City, when such trees constitute a hazard to life or property, or harbor insects or disease which constitutes a potential threat to other trees within the City. The City Forester will notify in writing the owners of such trees. Removal shall be done by said owners at their own expense within 30 days after the date of service of notice. In the event of failure of owners to comply with such provisions, the City shall have the authority to remove such trees and charge the cost of removal to the landowner or assess it to the property as a special charge. The City Forester may remove a tree or parts thereof on private property without notice to the owner where the tree is an immediate public safety hazard. (Ord 06OR002)

8.36.150. Tree Topping. It shall be unlawful for any person, to top any Street tree, City tree, or other tree on public property. Trees severely damaged by storms or other causes, or certain trees under utility wires or other obstructions where other pruning practices are impractical may be exempted from this ordinance at the determination of the Tree Board. (Ord 06OR002)

8.36.155 Protection of Trees in Construction Areas. All Street Trees and City Trees near any excavations or construction of any building, structure or street work shall be sufficiently guarded and protected by those responsible for such work as to prevent any injury to said trees.

The Tree Board shall develop construction policies and procedures and submit same to the Council for review and approval. (Ord 06OR002)

8.36.160. Sight Triangle. No trees can be planted in the "sight triangle" without obtaining a permit from the City Forester. (Ord 06OR002)

8.36.161 Seasonal pruning and removal of oak trees. To prevent the disease known as "oak wilt", no one shall remove, prune or cause fresh wounds to any oak tree or portion thereof, including roots between April 1 and November 1 without first securing written permission from the Tree Board. If storm damage work on oaks is required during this period, a sterile wound dressing shall be applied to all cut surfaces in accordance with current arboricultural standards. (Ord 06OR002)

8.36.162 Landscape plans. Public projects including but not limited to streets, parking facilities, boulevards, parks and public buildings shall have a landscape plan identifying the proposed planting and layout of trees and shrubs. Private projects involving multifamily residential, parking facilities, residential subdivision, institutional, commercial and industrial shall have a landscape plan identifying the proposed planting and layout of trees and shrubs. Landscape plans shall be presented to and approved by the Tree Board in accordance with published guidelines and standards.

The Tree Board shall develop such landscape guidelines and standards and submit same to the Council for review and approval. (Ord 06OR002)

8.36.170. Permits Required.

A. Planting, Maintenance and Removal.

1. No person shall plant, spray, fertilize, preserve, prune, remove, cut above ground, excavate or otherwise disturb any "City tree" without first filing an application and procuring a permit from the City Forester or otherwise specified municipal authority. The person receiving the permit shall abide by any arboricultural specifications and standards of practice adopted by the Tree Board.

2. Applications for permits must be made at City Hall not less than 5 (five) business days in advance of the time the work is to be done.

3. Standards of Issuance. The City Forester shall issue the permit provided for herein if, in his or her judgment, the proposed work is desirable and will be carried out in accordance with current arboricultural standards. Any permit granted shall contain a definite date of expiration and the work shall be completed in the time allowed on the permit and in the manner as therein described. Any permit shall be void if its terms are violated.

4. Notice shall be given within five days of completion of the work to the City Forester to provide for his inspection.

B. Planting.

1. Application Data. The application required herein shall state the number of trees to be set out, the location, size, species, cultivars or variety of each tree, the method of planting, and such other information, including landscape plans, as the City Forester shall find reasonable and necessary to a fair determination of whether a permit should be issued. (Ord 06OR002)

2. Improper Planting. Whenever any tree shall be planted in conflict with the provisions of this ordinance, it shall be lawful for the City Forester to remove or cause removal of the same, and the exact cost thereof shall be assessed to the owner as provided by law in the case of assessments.

C. Maintenance.

1. Application Data. The application required herein shall state the number and kinds of trees to be sprayed, fertilized, pruned, or otherwise preserved; the kind of treatment to be administered; the composition of the spray material to be applied; and such other information as the City Forester shall find reasonable and necessary to a fair determination of whether a permit should be issued. (Ord 06OR002)

8.36.180. Penalty. Any person violating any provision of this ordinance shall be, upon conviction or a plea of guilty, subject to a fine from \$25.00 to \$2,500.00. (Ord 06OR002)

8.36.190. Appeal. Any person who receives a determination, order, or denial of permit under this ordinance and objects to all or any part thereof, shall have the right to appeal such determination, order or denial to the Tree Board within ten (10) days of receipt of written notice of the order. The Tree Board shall hear such appeal within thirty (30) days of receipt of written notice of the appeal. After such hearing, the Tree Board may reverse, affirm or modify the determination, order, or denial and the grounds for its decision shall be stated in writing. The Tree Board shall, by letter, notify the party appealing the order of its decision within ten (10) days after the hearing has been concluded. The Tree Board shall file its written decision with the City Clerk-Treasurer. (Ord 06OR002)

Title 9PUBLIC PEACE, MORALS AND WELFAREChapters:

- 9.02 Unlawful discrimination in housing
- 9.04 Gambling
- 9.06 Resisting an Officer
- 9.08 Immoral Conduct
- 9.10 Destruction of Property; Theft; Worthless Checks
- 9.12 Intoxicating Liquors and Fermented Malt Beverages
- 9.14 Marijuana
- 9.16 Disorderly Conduct
- 9.18 Battery
- 9.20 Loitering on School Grounds
- 9.22 Truancy and School Dropout
- 9.24 Playing Ball in Streets Prohibited
- 9.26 Trespassing
- 9.28 Curfew
- 9.32 Pool and Billiard Halls
- 9.36 Firearms
- 9.37 Prohibiting Fraud on hotel or restaurant keeper
- 9.38 Shoplifting
- 9.40 Pornographic Materials and Performances
- 9.41 Drug Paraphernalia use by persons under 17 years of age
- 9.42 Harassment
- 9.44 Procedure for Citations
- 9.46 Prohibiting certain electronic messages
- 9.48 False Statement or Record

Chapter 9.02UNLAWFUL DISCRIMINATION IN HOUSINGSections:

- 9.02.010 Unlawful discrimination in housing.
- 9.02.020 Prevention and removal of unlawful discrimination.
- 9.02.030 Complaints

9.02.010 Unlawful discrimination in housing. Section 106.50, Wisconsin Statutes, as amended, and all subsequent amendments thereto, is hereby adopted. (OR09004)

July 2014 revision

9.02.020 Prevention and removal of unlawful discrimination. The officials and employees of the City of Viroqua shall assist in the orderly prevention and removal of all discrimination in housing within the City by implementing the authority and enforcement procedures set forth in Section 106.50, Wisconsin Statutes, as amended. (OR09004)

9.02.030 Complaints. The Municipal Clerk shall maintain any forms for complaints to be filed under Section 106.50, Wisconsin Statutes, as amended, and shall assist any person alleging a violation thereof in the City to file a complaint thereunder with the Wisconsin Department of Work Force Development, Equal Rights Division, for enforcement of Section 106.50, Wisconsin Statutes, as amended. (OR09004)

Chapter 9.04

GAMBLING

Sections:

- 9.04.010 Setting up an establishment - Prohibited - Penalty.
- 9.04.020 Prohibited - Penalty.
- 9.04.030 Suffering or permitting - Prohibited - Penalty.

9.040.010 Setting up an establishment - Prohibited - Penalty. Any person who sets up, keeps, manages or uses any table, wheel or other construction, or any cards, dice or other device, scheme, contrivance or thing of any name or description adapted, suitable, devised or designed, or which description adapted, suitable, devised or designed, or which can or shall be used for gambling purposes, and induces, entices or permits any person to gamble, bet or play for gain with, at or upon or by means of such table, wheel or other construction, or such cards, dice or other device, scheme, contrivance or thing, or to bet or wager anything at or upon any game whatever played by such keeper, manager or any other person by means or use thereof; or who opens, keeps or manages any common gambling house, shall be punished by a fine not exceeding five hundred dollars nor less than one hundred dollars. (Ord. 281 §1, 1977; Ord. 3 §1, 1904).

9.04.020 Prohibited – Penalty. Any person who bets or wagers any money, property or thing of value at or upon any game played by himself or by another with, at, upon or by means of the use of any table, wheel or other construction, or with, at, upon or by any cards, dice or other device, scheme, contrivance or thing adapted, suitable, devised, designed, or which can or shall be used for gambling purposes, shall be punished by a fine not exceeding one hundred dollars. (Ord. 281 §2, 1977; Ord. 3 §2, 1904).

9.04.030 Suffering or permitting – Prohibited – Penalty. Any person who knowingly suffers or permits any table, wheel or other construction, or any cards, dice or other device, scheme, contrivance or thing adapted, suitable, devised, designed or which can or is used for gambling purposes to be set up, kept, managed or used, or suffers or permits any gambling or betting therewith, thereon, or by means thereof in any house, building, shed, booth or on any lot or premises by him owned, occupied or controlled, shall be punished by a fine of not more than one hundred dollars. (Ord. 281 §3, 1977; Ord. 3 §3, 1904).

Chapter 9.06

RESISTING AN OFFICER

Sections:

9.06.010 Disobedience to, or interference with, a police officer.

9.06.010 Disobedience to, or interference with, a police officer. Whoever knowingly resists or obstructs an officer while such officer is doing any act in an official capacity shall be required to forfeit not more than two hundred dollars together with the costs of prosecution and in default in payment thereof shall be committed to the county jail until such forfeiture and costs are paid, not exceeding thirty days. "Obstruction" includes, without limitation, knowingly giving false information to the officer with intent to mislead him or her in the performance of his or her duties, including the service of any summon or civil process. "Officer" means a peace officer or other public officer or public employee having the authority by virtue of his office or employment to take another into custody. (Ord. 315 §1, 1980; Ord. 313 §1, 1980).

Chapter 9.08

IMMORAL CONDUCT

Sections:

9.08.010 Procreation of jackasses, stallions and bulls – Permission required.

9.08.020 Procreation of jackasses, stallions and bulls – Violation – Penalty.

9.08.010 Procreation of jackasses, stallions and bulls – Permission required. No person shall use any stallion, jackass or bull for procreative purposes in any residence part of the City except by permission of the Council. (Ord. 28 §1, 1915).

9.08.020 Procreation of jackasses, stallions and bulls – Violation – Penalty. Any person who violates Section 9.08.010 shall pay a fine not to exceed twenty -five dollars and costs of prosecution. (Ord. 28 §2, 1915).

Chapter 9.10

DESTRUCTION OF PROPERTY; THEFT; WORTHLESS CHECKS

Sections:

9.10.010 Destruction of Property.

9.10.020 Theft.

9.10.030 Worthless checks.

9.10.010 Destruction of property. Whoever intentionally causes damage to any physical property of another without the person's consent shall be required to forfeit not more than two hundred dollars together with costs of prosecution and in default in payment thereof, shall be committed to the county jail until such forfeiture and costs are paid, not exceeding thirty days. (Ord. 312 §1 (part), 1980).

9.10.020 Theft. A. Whoever does any of the following shall be penalized as provided in subsection B of this section:

1. Intentionally takes and carries away, uses, transfers, conceals, or retains possession of movable property of another without his consent and with intent to deprive the owner permanently of possession of such property;

2. Having a legal interest in movable property, intentionally and without consent, takes such property out of the possession of a pledgee or other person having a superior right of possession, with intent thereby to deprive the pledgee or other person permanently of the possession of such property;

3. Obtains title to property of another by intentionally deceiving him with a false representation which is known to be false, made with intent to defraud, and which does defraud the person to whom it is made. "False representation" includes a promise made with intent not to perform it if it is a part of a false and fraudulent scheme.

B. Whoever does any of the foregoing shall be required to forfeit not more than two hundred dollars together with the costs of prosecution and in default in payment thereof, shall be committed to the county jail until such forfeiture and costs are paid, not exceeding thirty days. (Ord. 312 §1 (part), 1980).

9.10.030 Worthless Checks. A. Whoever issues any check or other order for the payment of money which, at the time of issuance, he or she intends shall not be paid, shall be required to forfeit not less than \$100 nor more than \$300 for a first offense within a 12 month period, and not less than \$300 nor more than \$500 for a second or subsequent offense within a 12 month period, together with the costs of prosecution and in default of payment shall be imprisoned in the County Jail until such forfeiture and costs are paid but not more than thirty days. A judge may order a violator to make restitution under section 800.93, Wis. Stats., or similar or subsequent statute providing for restitution.

B Any of the following is prima facie evidence that the person at the time he or she issued the check or other order for the payment of money, intended it should not be paid:

(1) Proof that, at the time of issuance, the person did not have an account with the drawee; or

(2) Proof that, at the time of issuance, the person did not have sufficient funds or credit with the drawee and that the person failed within 5 days after receiving written notice of nonpayment or dishonor to pay the check or other order, delivered by regular mail to either the person's last-known address or the address provided on the check or other order; or

(3) Proof that, when presentment was made within a reasonable time, the person did not have sufficient funds or credit with the drawee and the person failed within 5 days after receiving written notice of nonpayment or dishonor to pay the check or other order, delivered by regular mail to either the person's last-known address or the address provided on the check or other order.

C. This section does not apply to a postdated check or to a check given for a past consideration, except a payroll check. (Ord. 393 §1, 1987; 05OR007).

Chapter 9.12

ALCOHOL BEVERAGES
INTOXICATING LIQUORS AND FERMENTED MALT BEVERAGES

Sections:

- 9.12.010 Open containers – Possession prohibited when in public places generally.
- 9.12.020 Open containers – Possession prohibited in areas used by motor vehicles.
- 9.12.030 Open containers – Possession prohibited when on business premises.
- 9.12.040 Penalty for violation of sections 9.12.010 through 9.12.030.
- 9.12.050 Underage persons, presence in places of sales.
- 9.12.060 Underage persons, restrictions, penalties.
- 9.12.070 Underage persons, prohibitions, penalties.
- 9.12.090 Intoxicated persons, sales to; penalty.

9.12.010 Open containers – Possession prohibited when in public places generally.
 No person shall be in possession of any intoxicating liquor or fermented malt beverage in an open container while in or upon any public street, alley, sidewalk, public parking lot or any public way, or any portion of the county fairgrounds or buildings during such time that there is any activity in progress at the fairgrounds which is open to the public, except where written permission therefor has been granted by the Vernon Agricultural Society. (Ord. 277, 1977; Ord. 243, 1972).

9.12.020 Open containers – Possession prohibited in areas used by motor vehicles.
 No person shall be in possession of any intoxicating liquor or fermented malt beverage in an open container while in or upon any premises held out to the public for use of motor vehicles, whether such premises are publicly or privately owned and whether or not a fee is charged for the use thereof. (Ord. 243, 1972).

9.12.030 Open containers – Possession prohibited when on business premises. No person shall be in possession of any intoxicating liquor or fermented malt beverage in an open container while in or upon any retail business establishment, professional office, gasoline service station, manufacturing plant or similar business premises generally opened to the public, unless such possession is with the permission of the owner, occupant or person in charge of such premises. (Ord. 243, 1972).

9.12.040 Violation - Penalty. Any person who violates any provision of section 9.12.010 through 9.12.030 shall be required to forfeit not less than twenty-five dollars nor more than two hundred dollars for each offense, together with the costs of prosecution, and upon default of payment of such forfeiture and costs shall be imprisoned in the county jail until such forfeiture and costs are paid, but not to exceed thirty days for each offense. (Ord. 433, 1992).

9.12.050 Presence in places of sales; penalty. (a) Restrictions. An "underage" person is defined in this chapter as a person who has not attained age 21. An underage person not accompanied by his or her parent, guardian or spouse who has attained the legal drinking age may not enter, knowingly attempt to enter or be on any premises for which a license or permit for the retail sale of alcohol beverages has been issued, for any purpose except the transaction of business pertaining to the licensed premises with or for the licensee or his or her employee. The business may not be amusement or the purchase, receiving or consumption of edibles or beverages or similar activities which normally constitute activities of a customer of the premises. This paragraph does not apply to:

1. An underage person who is a resident, employee, lodger or boarder on the premises controlled by the proprietor, licensee or permittee of which the licensed premises consists or is a part.
2. An underage person who enters or is on a "Class A" retail intoxicating liquor premises for the purpose of purchasing edibles or beverages other than alcohol beverages. An underage person so entering the premises may not remain on the premises after the purchase.
3. Hotels, drug stores, grocery stores, bowling alleys, cars operated by any railroad, regularly established athletic fields, stadiums, public facilities as defined in §125.51 (5)(b) 1.d which are owned by a county or municipality or centers for the visual or performing arts.
4. Premises in the state fair park, concessions authorized on state -owned premises in the state parks and state forests as defined or designated in chs. 27 and 28, and parks owned or operated by agricultural societies.
5. Ski chalets, golf clubhouses, racetracks licensed under the ch. 562, curling clubs, private soccer clubs and private tennis clubs.
6. Premises operated under both a Class "B" or "Class B" license or permit and a restaurant permit where the principal business conducted is that of a restaurant. If the premises are operated under both a Class "B" or "Class B" license or permit and a restaurant permit, the principal business conducted is presumed to be the sale of alcohol beverages, but the presumption may be rebutted by competent evidence.
7. An underage person who enters or remains on a Class "B" or "Class B" premises for the purpose of transacting business at an auction or market as defined in §125.32 (4)(b)1, Wis. Stats., if the person does not enter or remain in a room where alcohol beverages are sold or furnished.

8. An underage person who enters or remains in a room on Class "B" or "Class B" licensed premises separate from any room where alcohol beverages are sold or served, if no alcohol beverages are furnished or consumed by any person in the room where the underage person is present and the presence of underage persons is authorized under this subdivision. An underage person may enter and remain on Class "B" or "Class B" premises under this subdivision only if the municipality which issued the Class "B" or "Class B" license adopts an ordinance permitting underage persons to enter and remain on the premises as provided in this subdivision and the law enforcement agency responsible for enforcing the ordinance issues to the Class "B" or "Class B" licensee a written authorization permitting underage persons to be present under this subdivision on the date specified in the authorization. Before issuing the authorization, the law enforcement agency shall make a determination that the presence of underage persons on the licensed premises will not endanger their health, welfare or safety or that of other members of the community. The licensee shall obtain a separate authorization for each date on which underage persons will be present on the premises.

9. A person who is at least 18 years of age and who is working under a contract with the licensee, permittee or corporate agent to provide entertainment for customers on the premises.

10. An underage person who enters or remain on Class "B" or "Class B" licensed premises on a date specified by the licensee or permittee during times when no alcohol beverages are consumed, sold or given away. During those times, the licensee, the agent name in the license if the licensee is a corporation or a person who has an operator's license shall be on the premises unless all alcohol beverages are stored in a locked portion of the premises. The licensee shall notify the local law enforcement agency, in advance, of the times underage persons will be allowed on the premises under this subdivision.

(b) Penalties. A licensee or permittee who directly or indirectly permits an underage person to enter or be on a licensed premises in violation of par. (a) is subject to a forfeiture of not more than \$500. (Ord. 433, 1992).

9.12.060 Restrictions relating to underage persons; penalties. (a) Restrictions.

1. No person may procure for, sell, dispense or give away any alcohol beverages to any underage person not accompanied by his or her parent, guardian or spouse who has attained the legal drinking age.

2. No licensee or permittee may sell, vend, deal or traffic in alcohol beverages to or with any underage person not accompanied by his or her parent, guardian or spouse who has attained the legal drinking age.

3. No adult may knowingly permit or fail to take action to prevent the illegal consumption of alcohol beverages by an underage person on premises owned by the adult or under the adult's control. The subdivision does not apply to alcohol beverages used exclusively as part of a religious service.

4. No adult may intentionally encourage or contribute to a violation of section 9.12.070.

(b) Penalties.

1. In this paragraph "violation" means a violation of this section.

2. A person who commits a violation is subject to a forfeiture of:

a. Not more than \$500 if the person has not committed a previous violation within 12 months of the violation; or

b. Not less than \$200 nor more than \$500 if the person has committed a previous violation within 12 months of the violation.

3. A court shall suspend any license or permit issued under this chapter to a person for:

a. Not more than 3 days, if the court finds that the person committed a violation within 12 months after committing one previous violation.

b. Not less than 3 days nor more than 10 days, if the court finds that the person committed a violation within 12 months after committing 2 other violations; or

c. Not less than 15 days nor more than 30 days, if the court finds that the person committed the violation within 12 months after committing 3 other violations.

4. The court shall promptly mail notice of a suspension under this paragraph to the department and to the clerk of each municipality which has issued a license or permit to the person. (Ord. 433, 1992).

9.12.070 Underage persons; prohibitions; penalties. (a) Any underage person who does any of the following is guilty of a violation:

1. Procures or attempts to procure alcohol beverages.

3. Enters, knowingly attempts to enter or is on licensed premises in violation of section 9.12.050.

4. Falsely represents his or her age for the purpose of receiving alcohol beverages from a licensee or permittee.

(b) Except as provided in par. (bm), any underage person not accompanied by his or her parent, guardian or spouse who has attained the legal drinking age who knowingly possess or consumes alcohol beverages is guilty of a violation.

(bm) An underage person may possess alcohol beverages in the course of employment during his or her working hours if employed by any of the following:

1. A brewer.
2. A fermented malt beverages wholesaler.
3. A permittee other than a Class "B" or "Class B" permittee.
4. A facility for the production of alcohol fuel.
5. A retail licensee or permittee under the conditions specified in §125.32(2) or 125.68(2) Wis. Stats. or for delivery of unopened containers to the home or vehicle of a customer.
6. A campus, if the underage person is at least 18 years of age and is under the immediate supervision of a person who has attained the legal drinking age.

(c) Any person violating par. (a) or (b) is subject to the following penalties:

1. For a first violation, a forfeiture of not more than \$50.00.
2. For a violation committed within 12 months of a previous violation, a forfeiture of not more than \$100.00.
3. For a violation committed within 12 months of 2 or more previous violations, forfeiture of not more than \$500.00.

(cd) For purposes of par. (c), all violations arising out of the same incident or occurrence shall be counted as a single violation. (Ord. 433, 1992).

9.12.090 Sales of alcohol beverages to intoxicated persons; penalty.

(a) Restrictions.

1. No person may procure for, sell, dispense or give away alcohol beverages to a person who is intoxicated.
2. No licensee or permittee may sell, vend, deal or traffic in alcohol beverages to or with a person who is intoxicated.

(b) Penalties. Any person who violates par. (a) shall be fined not less than \$100 nor more than \$500 or imprisoned for not more than 60 days or both.

Chapter 9.14

MARIJUANA

Sections:

- 9.14.010 Possession of marijuana prohibited.
9.14.020 Violation – Penalty.

9.14.010 Possession of marijuana prohibited. It is unlawful for any person to possess the controlled substance of marijuana, as the same is defined in Section 161.01(14), Wis. Stats., except where such possession is lawful pursuant to Chapter 161, Wis. Stats. (Ord. 332, 1982).

9.14.020 Violation – penalty. Any person who violates Section 9.14.010 shall, upon conviction, be required to forfeit not less than fifty dollars nor more than two hundred dollars together with the costs of prosecution, and in default of payment thereof shall be committed to the county jail until said forfeiture and costs are paid, not exceeding thirty days. (Ord. 332 §1(part), 1982).

Chapter 9.16

DISORDERLY CONDUCT

Sections:

- 9.16.010 Assemblies – Interruption or molestation prohibited – Penalty
- 9.16.020 False alarms – Prohibited – Penalty
- 9.16.030 Prohibited acts generally – Designated.
- 9.16.040 Prohibited acts generally – Violation by minors – Referral to juvenile court
- 9.16.050 Prohibited acts generally – Violation – Penalty.

9.16.010 Assemblies – Interruption or molestation prohibited – Penalty. Any person who at any time willfully or wantonly interrupts or molests any assembly or meeting of people for religious worship or for other purposes, lawfully and peacefully assembled, shall be punished by a fine not less than five dollars nor more than fifty dollars and the costs of prosecution. (Ord. 6 §4, 1904).

9.16.020 False alarms – Prohibited – Penalty. (A) FALSE FIRE ALARMS. In addition to any fee that may be imposed for the circumstances described in section 3.22.010 of the Viroqua Municipal Code for a false fire alarm, any person who intentionally makes a false alarm of fire shall be required to forfeit not less than \$250 nor more than \$500 together with the costs of prosecution and in default of payment shall be imprisoned in the County jail, not exceeding 30 days.

(B) FALSE POLICE ALARMS. Any person who intentionally makes a false police alarm shall be required to forfeit not less than \$250 nor more than \$500 together with the costs of prosecution and in default of payment shall be imprisoned in the County jail, not exceeding 30 days. The owner of an alarm system who by negligence alerts the police when in fact no emergency exists, for the third and each subsequent such negligent alerts within the previous 12 months, shall be required to forfeit not less than \$250 nor more than \$500 together with the costs of prosecution and in default of payment shall be imprisoned in the County jail, not exceeding 30 days. [Ord. 6 §5, 1904; Ordinance 06OR007]

9.16.030 Prohibited acts generally – Designated. No person shall make or use loud or boisterous language or any language tending to excite a breach of the peace; or shall be engaged in fighting or shall make or assist in making any riot, noise or other disturbance in the city; or shall aid or abet any riotous or disorderly assembly therein; or shall commit any disorderly or improper conduct tending to cause or provoke a disturbance. (Ord. 253 §1, 1973).

9.16.040 Prohibited acts generally – Violation by minors – Referral to juvenile court. The violation of Section 9.16.030 by a minor shall be basis for referring such minor to the juvenile court for appropriate action. (Ord. 253 §2, 1973).

9.16.050 Prohibited acts generally – Violation – Penalty. Any person who violates the provisions of Section 9.16.030 and 9.16.040 shall be required to forfeit not less than \$50.00 nor more than \$200.00, together with the costs of prosecution, and in default of payment of such forfeiture and costs shall be imprisoned in the county jail until such forfeiture and costs are paid, not exceeding 30 days. (Ord. 418, 1990; Ord. 253 §3, 1973).

Chapter 9.18

BATTERY

Section:

9.18.010 Battery

9.18.010 Battery. Whoever causes bodily harm to another by an act done with intent to cause bodily harm to that person or another without the consent of the person so harmed shall be required to forfeit \$500.00 together with the costs of prosecution and in default of payment shall be imprisoned in the County Jail not exceeding 30 days. (Ord 08OR009)

Chapter 9.20

LOITERING ON SCHOOL GROUNDS

Sections:

9.20.010	Applicability.
9.20.020	Unlawful when – Authorized person defined.
9.20.030	Explanation of presence required when.
9.20.040	Unauthorized entry prohibited – Notice on school building entrances.
9.20.050	Minibikes and snowmobiles – Operation unlawful when.
9.20.060	Use of controlled substances unlawful.
9.20.070	Violation – penalty.

9.20.010 Applicability. This chapter shall only apply to property under the jurisdiction of the Viroqua Area School District within the jurisdictional limits of the city. (Ord. 266 §7, 1975).

9.20.020 Unlawful when – Authorized person defined. A. It is unlawful for any student who is under suspension, expulsion, exemption or other discipline excluding him or her from attending school under the jurisdiction of the Viroqua Area School District; or for any person not a student presently enrolled to attend school under the jurisdiction of the Viroqua Area School District; or not an employee of said Viroqua Area School District; or not a parent or guardian of a student so enrolled; or not an otherwise “authorized person”, to be present within any school building or upon any school grounds under the jurisdiction of said school district without having first secured authorization to be there from the principal or other person in charge of said school building or school grounds, except while in direct route to secure said authorization.

B. “Authorized person” includes any person who is present at any school building or school grounds for any purpose previously authorized by the school board or its designee. (Ord. 266 §1, 1975).

9.20.030 Explanation of presence required when. Any person shall, upon request of the principal or other person in charge of any school building, or upon any school grounds under the jurisdiction of the Viroqua Area School District, or upon request of any police officer, display any written authorization to be present which he or she may have in his or her possession or otherwise explain his or her presence or his or her status as such student, employee, parent, guardian, or “authorized person” as defined in subsection B of Section 9.20.020. (Ord. 266 §2, 1975).

9.20.040 Unauthorized entry prohibited – Notice on school building entrances. All entrances to the school buildings referred to in Section 9.20.020 shall be posted with a notice stating “Entry into School Building by Unauthorized Persons Prohibited.” (Ord. 266 §3, 1975).

9.20.050 Minibikes and snowmobiles – operation unlawful when. It is unlawful to use or operate minibikes and snowmobiles upon any school grounds under the jurisdiction of the Viroqua Area School District except upon or along such trails as may from time to time be authorized by said District for such operation. (Ord. 266 §4, 1975).

9.20.060 Use of controlled substances unlawful. It is unlawful for any person to possess or use any controlled substance, as that term is defined in the Wisconsin Statutes, within any school building or upon any school grounds under the jurisdiction of the Viroqua Area School District. (Ord. 266 §5, 1975).

9.20.070 Violation – Penalty. Any person who violates any of the provisions of this chapter shall, upon conviction, be subject to a forfeiture of not less than ten dollars nor more than five hundred dollars for each offense. (Ord. 266 §6, 1975).

Chapter 9.22

TRUANCY AND SCHOOL DROPOUT

Sections:

9.22.010	Definitions
9.22.020	Truancy prohibited
9.22.030	Habitual Truancy prohibited
9.22.040	Dropping out prohibited

Section 9.22.010 Definitions.

(a) “Dropout” means a child who ceased to attend school, does not attend a public or private school, technical college or home-based private educational program on a full-time basis, has not graduated from high school and does not have an acceptable excuse under state statute section 118.15. (Ord 520, 2000)

(b) “Habitual truant” means a pupil who is absent from school for part or all of 5 or more days on which school is held during a school semester without an acceptable excuse according to school policy and state statute section 118.15

(c) “Operating privilege” has the meaning given in state statute section 340.01(40).

(d) “Truant” means a pupil who is absent from school for part or all of any day on which school is held during a school semester without an acceptable excuse under state statute sections 118.15 and 118.16 (4).

Section 9.22.020 Truancy prohibited: It is prohibited for a person under 18 years of age to be a truant. A person who violates this section is subject to the following dispositions:

- a) An order for the person to attend school.
- b) A forfeiture of not more than \$50 plus costs for a first violation, or a forfeiture of not more than \$100 plus costs for any 2nd or subsequent violation committed within 12 months of a previous violation, subject to s. 938.37 and subject to a maximum cumulative forfeiture amount of not more than \$500 for all violations committed during a school semester. All or part of the forfeiture plus costs may be assessed against the person, the parents or guardian of the person, or both.

Section 9.22.030 Habitual Truancy prohibited It is prohibited for a person under 18 years of age to be a habitual truant. A person who violates this section is subject to the following dispositions:

- a) Suspension of the person's operating privilege for not less than 30 days nor more than one year. The court shall immediately take possession of any suspended license and forward it to the department of transportation together with a notice stating the reason for and the duration of the suspension.
- b) An order for the person to participate in counseling or a supervised work program or other or other community service work as described in s. 938.34(5g). The costs of any such counseling, supervised work program or other community service work may be assessed against the person, the parents or guardian of the person, or both. Any county department of human services or social services, community agency, public agency or nonprofit charitable organization administering a supervised work program or other community service work to which a person is assigned pursuant to an order under this paragraph acting in good faith has immunity from any civil liability in excess of \$25,000 for any act or omission by or impacting on that person.
- c) An order for the person to remain at home except during hours in which the person is attending religious worship or a school program including travel time required to get to and from the school program or place of worship. The order may permit a person to leave his or her home if the person is accompanied by a parent or guardian.
- d) An order for the person to attend an educational program as described in s. 938.34(7d).
- e) An order for the department of workforce development to revoke, under s. 103.72, a permit under s. 103.70 authorizing the employment of the person.
- f) An order for the person to be placed in a teen court program as described in s. 938.342(1g)(f).

- g) An order for the person to attend school.
- h) A forfeiture of not more than \$500.00 plus costs, subject to s. 938.37. All or part of the forfeiture plus costs may be assessed against the person, the parents or guardian of the person, or both.
- i) Any other reasonable conditions consistent with this subsection, including a curfew, restrictions as to going to or remaining on specified premises and restrictions on associating with other children or adults.
- j) An order placing the person under formal or informal supervision, as described in s. 938.34(2), for up to one year.
- k) An order for the person's parent, guardian or legal custodian to participate in counseling at the parent's guardian's or legal custodian's own expense or to attend school with the person, or both.

Section 9.22.040 Dropping out prohibited: It is prohibited for a person who is at least 16 years of age but less than 18 years of age to be a dropout. The court may suspend the operating privilege of a person who violates this section until the person reaches the age of 18. The court shall immediately take possession of any suspended license and forward it to the department of transportation with a notice stating the reason for and the duration of the suspension.

Chapter 9.24

PLAYING BALL IN STREETS PROHIBITED

Sections:

9.24.010 Playing ball in streets prohibited – Penalty.

9.24.010 Playing ball in streets prohibited – Penalty. Any person who throws or in any manner plays with a baseball or other ball in any of the streets of the city shall be punishable by a fine not to exceed five dollars and costs of prosecution. (Ord. 8 §1, 1904).

Chapter 9.26

TRESSPASSING

Sections:

- 9.26.010 Prohibited.
- 9.26.020 Violation – Penalty.

9.26.010 Prohibited. No person may enter or remain on any land of another after having been notified by the owner or occupant or his or her agent not to enter or remain on the premises. (Ord. 331 §1, 1982).

9.26.020 Violation – Penalty. Any person who violates this chapter shall be required to forfeit not less than twenty-five dollars nor more than one hundred dollars, together with the costs of prosecution, and in default of payment, shall be committed to the county jail until such forfeiture and costs are paid, not exceeding thirty days. (Ord. 332 §2, 1982).

Chapter 9.28

CURFEW

Sections:

- 9.28.010 Hours designated – Exceptions.
- 9.28.020 Violation by child – Penalty.
- 9.28.030 Violation by parent or guardian – Penalties.

9.28.010 Hours designated – Exceptions. No child who has not reached his sixteenth birthday shall be or remain in or upon any of the streets, alleys or public places in the city between the hours of ten p.m. and five a.m., and no parent or guardian of a child who has not reached his sixteenth birthday shall permit such child to be or remain in said places during such hours unless such child is accompanied by a parent, guardian or some person of lawful age having the legal custody of such child; or unless he is in the performance of an errand or duty as directed by such parents, guardian or other persons; or unless he is going home from school activities, church programs or approved organizational activities; or unless his employment makes it necessary for him to be upon said streets, alleys or public places, in which case this section shall not apply. (Ord. 251 §1, 1973).

9.28.020 Violation by child – Penalty. Any child violating the provisions of Section 9.28.010 shall be warned by any police officer to go home and, if such person disobeys such warning, he may be taken to his home by the police officer. Habitual violators of the terms of this chapter may be referred to the juvenile court for appropriate action. (Ord. 251 §1(2), 1973).

9.28.030 Violation by parent or guardian – Penalties. Any parent or guardian who permits his child or children to violate the provisions of Section 9.28.010, after having been warned in writing, shall, upon conviction, forfeit the sum of five dollars without costs for the first offense, ten dollars without costs for the second offense, and twenty -five dollars together with costs for any subsequent offense. Upon default of the payment of such forfeiture or costs, the offender may be imprisoned in the county jail until such forfeiture and costs are paid, but not to exceed five days for each offense. (Ord. 251 §1(3), 1973).

Chapter 9.32

POOL AND BILLARD HALLS

Sections:

- | | |
|----------|--|
| 9.32.010 | Purpose. |
| 9.32.020 | Prohibited hours of operation. |
| 9.32.030 | Prohibited presence on premises – Ejection by owner required when. |
| 9.32.040 | Permit to be present – Procedure. |
| 9.32.050 | Violation – Penalty. |

9.32.010 Purpose. This chapter shall be deemed an exercise of the home rule amendment to the Constitution of this state by the city, as an exercise of the police power of the city to promote the public welfare and the morals of minors, as an aid to the public safety and health. (Ord. 114 §1, 1945).

9.32.020 Prohibited hours of operation. All pool halls and billiard halls shall be closed and remain closed between the hours of midnight and eight a.m. all nights of the week except Saturday night, when they shall be closed at one a.m. and shall remain closed from said time until one p.m. Sunday. (Ord. 114 §2, 1945).

9.32.030 Prohibited presence on premises – Ejection by owner required when. No person under eighteen years of age shall be permitted to frequent, loiter, enter or remain in any pool hall or billiard hall, or to loiter or loaf within such licensed place, unless accompanied by a parent; provided, however, that persons between the ages of fourteen and eighteen years shall be permitted to enter a pool hall or billiard hall, unaccompanied by a parent, to play pool or billiards if they have first obtained a permit to play as provided in Section 9.32.040. If such person under the age of fourteen years, or between fourteen and eighteen years of age who has no such permit to play, enters any such licensed premises unaccompanied by a parent, they shall be immediately ejected therefrom by the licensee or person in charge thereof, and failure to eject any such minor from such premises forthwith shall be deemed a violation of this chapter and the license of such pool hall or billiard hall keeper may be summarily revoked by the council and such licensed premises closed and abated. (Ord. 193 §1, 1961; Ord. 114 §3, 1945).

9.32.040 Permit to be present – Procedure. No owner or keeper of any pool hall or billiard hall, and no agent or servant of such owner or keeper, shall allow or in any manner permit any person between the ages of fourteen and eighteen years to play any game therein unless the parent or guardian of such minor person has first applied to the city clerk for a permit authorizing such minor to play pool or billiards and has secured such permit. Permits shall be issued only upon the application of the parent or guardian of any such minor, which permit shall be signed by the parent or guardian in the presence of and witnessed by the city clerk. Such permit shall be executed in triplicate: one copy shall be kept on file in the city clerk's office; one copy shall be kept on file at the city police station; and one copy shall be given to the parent of such minor child. Such permit shall be exhibited to the pool hall or billiard hall proprietor before any such minor between the ages of fourteen and eighteen years is permitted to play any game in such licensed places. It shall be the duty of the licensee of any such pool hall or billiard hall to see to it that all such prohibited persons are ejected therefrom forthwith. (Ord. 114 §4, 1945).

9.32.050 Violation – Penalty. Any person who violates any of the provisions of this chapter shall, in addition to all other penalties, be fined not less than twenty-five dollars nor more than fifty dollars, and the costs of prosecution, and shall stand committed to the common jail of the county until said fine and costs are paid, not to exceed three months. (Ord. 114 §5, 1945).

Chapter 9.36

FIREARMS

Sections:

- 9.36.010 Unlawful use or possession – Exceptions.
- 9.36.020 Possession as presumptive evidence.
- 9.36.030 Violation by minor – Referral to juvenile court.
- 9.36.040 Violation – Penalty.

9.36.010 Unlawful use or possession – Exceptions. It is unlawful to use, discharge or possess with intent to use or discharge any firearm, airgun, BB gun or pellet gun; or any so-called slingshot or similar device which projects a missile by the use of rubber bands, tubing or straps; or any toy gun projecting any type of missile, except those type of missiles which clearly are incapable of causing injury or property damage, except in a regularly established shooting range. This section shall not be construed to prohibit any officer of the law from discharging a firearm in the performance of his duty, nor to prohibit any citizens from discharging a firearm when lawfully defending person or property. (Ord. 254 §q, 1973).

9.36.020 Possession as presumptive evidence. The possession of any of the devices prohibited in Section 9.36.010 except in the home/or upon the business premises of the possessor, shall be presumptive evidence of possession with intent to use or discharge in violation of this chapter unless such device is securely enclosed in a holster, wrapping or case. (Ord. 254 §2, 1973).

9.36.030 Violation by minor – Referral to juvenile court. The violation of this chapter by a minor shall be basis for referring such minor to the juvenile court for appropriate action. (Ord. 254 §3, 1973).

9.36.040 Violation – Penalty. Any person who violates the provisions of this chapter shall forfeit not less than ten dollars nor more than fifty dollars for each offense, together with the costs of prosecution. Upon default of the payment of such forfeiture or costs, the offender may be imprisoned in the county jail until such forfeiture and costs are paid, but not to exceed ten days for each offense. (Ord. 254 §4, 1973).

CHAPTER 9.37

PROHIBITING FRAUD ON HOTEL OR RESTAURANT KEEPER

Sections:

- 9.37.010 May be required to pay a forfeiture.
- 9.37.020 Prima facie evidence of an intent to defraud.
- 9.37.030 Forfeitures for violations.
- 9.37.040 Judge ordered restitution.
- 9.37.050 Judgment may not be entered.

9.37.010 May be required to pay a forfeiture. Whoever does either of the following may be required to pay a forfeiture as provided in Section 9.37.030:

(a) Having obtained any beverage, food, lodging or other service or accommodation at any campground, hotel, motel, boarding or lodging house, or restaurant, intentionally absconds without paying for it.

(b) While a guest at any campground, hotel, motel, boarding or lodging house, or restaurant, intentionally defrauds the keeper thereof in any transaction arising out of the relationship as guest.

9.37.020 Prima facie evidence of an intent to defraud. Under this section, prima facie evidence of an intent to defraud is shown by:

(a) The refusal of payment upon presentation when due, and the return unpaid of any bank check or order for the payment of money, given by any guest to any campground, hotel, motel, boarding or lodging house, or restaurant, in payment of any obligation arising out of the relationship as guest. Those facts also constitute prima facie evidence of an intent to abscond without payment.

(b) The failure or refusal of any guest at a campground, hotel, motel, boarding or lodging house, or restaurant, to pay, upon written demand, the established charge for any beverage, food, lodging or other service or accommodation actually rendered.

(c) The giving of false information on a lodging registration form or the giving of false information or presenting of false or fictitious credentials for the purpose of obtaining any beverage or food, lodging or credit.

(d) The drawing, endorsing, issuing or delivering to any campground, hotel, motel, boarding or lodging house, or restaurant of any check, draft or order for payment of money upon any bank or other depository, in payment of established charges for any beverage, food, lodging or other service or accommodation, knowing at the time that there is not sufficient credit with the drawee bank or other depository for payment in full of the instrument drawn.

9.37.030 Forfeitures for violations. Whoever violates this chapter:

(a) Shall be required to forfeit not more than \$300 when the value of any beverage, food, lodging, accommodation or other service is \$1,000 or less.

(b) Shall be required to forfeit not more than \$500 when the value of any beverage, food, lodging, accommodation or other service exceeds \$1,000.

9.37.040 Judge ordered restitution. In addition to the other penalties provided for violation of this chapter, a judge may order a violator to pay restitution.

9.37.050 Judgment may not be entered. A judgment may not be entered for a violation of this chapter, regarding conduct that was the subject of a judgment including exemplary damages under s.943.212.

Chapter 9.38SHOPLIFTINGSections:

9.38.010 Shoplifting.

9.38.010 Shoplifting. A. Whoever intentionally alters indicia of price or value of merchandise or who takes and carries away, transfers, conceals or retains possession of merchandise held for resale by a merchant without his consent and with intent to deprive the merchant permanently of possession, or the full purchase price, of such merchandise may be penalized, as provided in subsection C.

B. The intentional concealment of unpurchased merchandise which continues from one floor to another or beyond the last station for receiving payments in a merchant's store is evidence of intent to deprive the merchant permanently of possession of such merchandise without paying the purchase price thereof. The discovery of unpurchased merchandise concealed upon the person or among the belongings of such person or concealed by a person upon the person or among the belongings of another is evidence of intentional concealment on the part of the person so concealing such goods.

C. Whoever violates this section shall, upon conviction, be required to forfeit not less than twenty-five dollars nor more than two hundred dollars, together with the costs of prosecution, and upon default in payment, shall be committed to the county jail until said forfeiture and costs are paid, not exceeding thirty days. (Ord. 309 §1, 1980).

Chapter 9.40PORNOGRAPHIC MATERIALS AND PERFORMANCESSections:

9.40.010 Definitions.
 9.40.020 Distribution of material prohibited.
 9.40.030 Performance prohibited.
 9.40.040 Library, school and religious material – Presumption of legality.
 9.40.050 Unlawful performance – May be enjoined.
 9.40.060 Right of legal proceedings.
 9.40.070 Violation of Sections 9.40.020 and 9.40.030 – Penalty.

9.40.010 Definitions. As used in this chapter:

- A. "Distribute" means to transfer possession of, with or without consideration.
- B. "Material" means any printed matter, visual representation, or sound recording, and includes but is not limited to books, magazines, photographs, drawings, sculpture, and tape or wire recordings.
- C. "Nudity" means uncovered or less than opaquely covered postpubertal human genitals, pubic areas, the postpubertal human female breast below a point immediately above the top of the areola, or the covered human male genitals in a discernibly turgid state. For purposes of this definition, a female breast is considered uncovered if the nipple only and the areola only are covered.
- D. "Performance" means any play, motion picture film, dance or other exhibition performed before an audience.
- E. "Person" means any individual, partnership, firm, association, corporation or other legal entity.
- F. "Pornographic" means any material or performance which:
 1. Taken as a whole, the dominant theme of the material or performance appeals to a prurient interest in sex, and
 2. Is patently offensive because it affronts contemporary community standards relating to the description or representation of sexual matter; and
 3. Is utterly without redeeming literary, artistic, political, scientific or social value.
- G. "Sado-masochistic abuse" means either:
 1. Flagellation or torture by or upon a person who is nude or clad in undergarments or in revealing or bizarre costume; or,
 2. The condition of being fettered, bound or otherwise physically restrained on the part of a person who is nude or clad in undergarments or in revealing or bizarre costume.
- H. "Sexual conduct" means ultimate sexual acts including but not limited to masturbation, homosexuality, lesbianism, bestiality, sexual intercourse, fellatio or cunnilingus. (Ord. 294 §1, 1970).

9.40.020 Distribution of material prohibited. It is unlawful for any person to exhibit, distribute or offer to distribute or have in his possession with intent to distribute any material portraying sado-masochistic abuse, sexual conduct or nudity which is pornographic. (Ord. 294 §3, 1978).

9.40.030 Performance prohibited. It is unlawful for any person to give, advertise, produce, exhibit or perform in any performance which portrays sado-masochistic abuse, sexual conduct or nudity which is pornographic in any playhouse, theatre, hall or other place within the city. (Ord. 294 §3, 1978).

9.40.040 Library, school and religious material – Presumption of legality. It shall be presumed, until competent evidence to the contrary is admitted, that material in the city library, Viroqua Area Schools, and bona fide religious organizations is not pornographic. (Ord. 294 §4, 1978).

9.40.050 Unlawful performance – May be enjoined. Any performances declared by this chapter to be unlawful constitutes a public nuisance and may be enjoined. (Ord. 294 §5, 1978).

9.40.060 Right of legal proceedings. Any resident of the city is given standing to institute legal proceedings to obtain a declaratory judgment whether any material or performance portraying sado-masochistic abuse, sexual conduct or nudity is, or is not, pornographic. (Ord. 294 §6, 1978).

9.40.070 Violation of Sections 9.40.020 and 9.40.030 – Penalty. Any person who violates any of the provisions of Section 9.40.020 and 9.40.030 shall, upon conviction, be required to forfeit not less than two hundred dollars nor more than five hundred dollars, together with the costs of prosecution, and in default of payment thereof shall be committed to the county jail until said fine and costs are paid, not exceeding thirty days. (Ord. 294 §7, 1978).

Chapter 9.41

DRUG PARAPHERNALIA

Sections:

9.41.010	Definitions.
9.41.020	Determinations.
9.41.030	Possession of drug paraphernalia.
9.41.040	Manufacture or delivery of drug paraphernalia.
9.41.050	Delivery of drug paraphernalia to a minor.

9.41.010 Definitions. In this Chapter:

(1)(a) "Drug paraphernalia" means all equipment, products and materials of any kind that are used, designed for use or primarily intended for use in planting, propagating, cultivating, growing, harvesting, manufacturing, compounding, converting, producing, processing, preparing, testing, analyzing, packaging, repackaging, storing, containing, concealing, injecting, ingesting, inhaling or otherwise introducing into the human body a controlled substance or controlled substance analog in violation of this chapter. "Drug paraphernalia" includes, but is not limited to, any of the following:

1. Kits used, designed for use or primarily intended for use in planting, propagating, cultivating, growing or harvesting of any species of plant that is a controlled substance or from which a controlled substance or controlled substance analog can be derived.
2. Kits used, designed for use or primarily intended for use in manufacturing, compounding, converting, producing, processing or preparing controlled substances or controlled substance analogs.
3. Isomerization devices used, designed for use or primarily intended for use in increasing the potency of any species of plant that is a controlled substance.
4. Testing equipment used, designed for use or primarily intended for use in identifying, or in analyzing the strength, effectiveness or purity of, controlled substances or controlled substance analogs.
5. Scales and balances used, designed for use or primarily intended for use in weighing or measuring controlled substances or controlled substance analogs.
6. Dilutents and adulterants, such as quinine hydrochloride, mannitol, mannite, dextrose and lactose, used, designed for use or primarily intended for use in cutting controlled substances or controlled substance analogs.
7. Separation gins and sifters used, designed for use or primarily intended for use in removing twigs and seeds from, or in otherwise cleaning or refining, marijuana.
8. Blenders, bowls, containers, spoons and mixing devices used, designed for use or primarily intended for use in compounding controlled substances or controlled substance analogs.
9. Capsules, balloons, envelopes and other containers used, designed for use or primarily intended for use in packaging small quantities of controlled substances or controlled substance analogs.
10. Containers and other objects used, designed for use or primarily intended for use in storing or concealing controlled substances or controlled substance analogs.
11. Objects used, designed for use or primarily intended for use in ingesting, inhaling or otherwise introducing marijuana, cocaine, hashish or hashish oil into the human body, such as:
 - a. Metal, wooden, acrylic, glass, stone, plastic or ceramic pipes with or without screens, permanent screens, hashish heads or punctured metal bowls.
 - b. Water pipes.
 - c. Carburetion tubes and devices.

- d. Smoking and carburetion masks.
- e. Roach clips: meaning objects used to hold burning material, such as a marijuana cigarette, that has become too small or too short to be held in the hand.
- f. Miniature cocaine spoons and cocaine vials.
- g. Chamber pipes.
- h. Carburetor pipes.
- i. Electric pipes.
- j. Air-driven pipes.
- k. Chilams.
- L. Bongs.
- m. Ice pipes or chillers.

(b) "Drug paraphernalia" excludes:

1. Hypodermic syringes, needles and other objects used or intended for use in parenterally injecting substances into the human body.
2. Any items, including pipes, papers and accessories, that are designed for use or primarily intended for use with tobacco products.

(2) "Primarily" means chiefly or mainly. [Ord 489, 1999; Ord 06OR006]

9.41.020 Determinations. (1) In determining whether an object is drug paraphernalia, a court or other authority shall consider, in addition to all other legally relevant factors, the following:

- (a) Statements by an owner or by anyone in control of the object concerning its use.
- (b) The proximity of the object, in time and space, to a direct violation of this chapter.
- (c) The proximity of the object to controlled substances or controlled substance analogs.
- (d) The existence of any residue of controlled substances or controlled substance analogs on the object.

(e) Direct or circumstantial evidence of the intent of an owner, or of anyone in control of the object, to deliver it to persons whom he or she knows intend to use the object to facilitate a violation of this chapter; the innocence of an owner, or of anyone in control of the object, as to a direct violation of this chapter shall not prevent a finding that the object is designed for use or primarily intended for use as drug paraphernalia.

(f) Instructions, oral or written, provided with the object concerning its use.

(g) Descriptive materials accompanying the object that explain or depict its use.

(h) Local advertising concerning its use.

(i) The manner in which the object is displayed for sale.

(j) Whether the owner, or anyone in control of the object, is a legitimate supplier of like or related items to the community, such as a licensed distributor or dealer of tobacco products.

(k) The existence and scope of legitimate uses for the object in the community.

(L) Expert testimony concerning its use.

(2) In determining under this subchapter whether an item is designed for a particular use, a court or other authority shall consider the objective physical characteristics and design features of the item.

(3) In determining under this subchapter whether an item is primarily intended for a particular use, a court or other authority shall consider the subjective intent of the defendant. [Ord 489, 1999; Ord 06OR006]

9.41.030 Possession of drug paraphernalia. (1) No person may use, or possess with the primary intent to use, drug paraphernalia to plan, propagate, cultivate, grow, harvest, manufacture, compound, convert, produce, process, prepare, test, analyze, pack, repack, store, contain, conceal, inject, ingest, inhale or otherwise introduce into the human body a controlled substance or controlled substance analog in violation of this chapter. Any person who violates this subsection may be required to forfeit not more than \$500 together with the costs of prosecution.

(2) No person may use, or possess with the primary intent to use, drug paraphernalia to manufacture, compound, convert, produce, process, prepare, test, analyze, pack, repack or store methamphetamine or a controlled substance analog of methamphetamine in violation of this chapter. Any person who violates this subsection may be required to forfeit not more than \$500 together with the costs of prosecution. [Ord 489, 1999; Ord 06OR006]

9.41.040 Manufacture or delivery of drug paraphernalia. (1) No person may deliver, possess with intent to deliver, or manufacture with intent to deliver, drug paraphernalia, knowing that it will be primarily used to plant, propagate, cultivate, grow, harvest, manufacture, compound, convert, produce, process, prepare, test, analyze, pack, repack, store, contain, conceal, inject, ingest, inhale or otherwise introduce into the human body a controlled substance or controlled substance analog in violation of this chapter. Any person who violates this subsection may be required to forfeit not more than \$1,000 together with the costs of prosecution.

(2) No person may deliver, possess with intent to deliver, or manufacture with intent to deliver, drug paraphernalia, knowing that it will be primarily used to manufacture, compound, convert, produce, process, prepare, test, analyze, pack, repack or store methamphetamine or a controlled substance analog of methamphetamine in violation of this chapter. Any person who violates this subsection may be required to forfeit not more than \$1,000 together with the costs of prosecution. [Ord 489, 1999; Ord 06OR006]

9.41.050 Delivery of drug paraphernalia to a minor. (1) Any person 17 years of age or over who violates 9.41.040 by delivering drug paraphernalia to a person 17 years of age or under who is at least 3 years younger than the violator may be required to forfeit not more than \$2,000 together with the costs of prosecution. [Ord 489, 1999; Ord 06OR006]

Chapter 9.42

HARASSMENT

Sections:

- 9.42.010 Harassment prohibited.
- 9.42.020 Penalty.

9.42.010 Harassment prohibited. No person shall, with intent to harass or intimidate another person, do any of the following:

- a) strikes, shoves, kicks, or otherwise subjects the person to physical contact or attempts or threatens to do the same;
- b) engages in a course of conduct or repeatedly commits acts which harass or intimidate the person and which serve no legitimate purpose. (Ord. 392 S. 1, 1987).

9.42.020 Penalty. Any person who violates this Chapter shall be required to forfeit not less than \$50 nor more than \$200 together with the costs of prosecution, and in default of payment thereof, shall be committed to the county jail until such forfeiture and costs are paid, not exceeding 30 days. (Ord. 392 §1, 1987).

Chapter 9.44

CITATION PROCEDURE AND BOND AMOUNTS

Sections:

- 9.44.010 State law adopted.
- 9.44.020 Form of Citation.
- 9.44.030 Citations issued by officers.
- 9.44.040 Deposits.
- 9.44.050 Bond Amounts.
- 9.44.060 Violator’s options; procedure on default.

9.44.010 State law adopted. Pursuant to the provisions of Section 66.119, Wisconsin Statutes, the form and use of a citation is hereby authorized. (Ord. 406, 1989)

9.44.020 Form of Citation. The form of the citation shall provide for the following:

- 1. The name and address of the alleged violator.

2. The factual allegations describing the alleged violation.
3. The time and place of the offense.
4. The section of the ordinance violated.
5. A designation of the offense in such manner as can be readily understood by a person making a reasonable effort to do so.
6. The time at which the alleged violator may appear in court.
7. A statement which in essence informs the alleged violator:
 - a) That the alleged violator may make a cash deposit of a specified amount to be mailed to a specified official within a specified time.
 - b) That if the alleged violator makes such a deposit, he or she need not appear in court unless subsequently summoned.
 - c) That if the alleged violator makes a cash deposit and does not appear in court, either he or she will be deemed to have tendered a plea of no contest and submitted to a forfeiture, a penalty assessment imposed by §165.87 and a jail assessment imposed by §53.46(1) not to exceed the amount of the deposit or will be summoned into court to answer the complaint if the court does not accept the plea of no contest.
 - d) That if the alleged violator does not make a cash deposit and does not appear in court at the time specified, an action may be commenced against the alleged violator to collect the forfeiture, the penalty assessment imposed by §165.87 and the jail assessment imposed by §53.46(1).
 - e) A direction that if the alleged violator elects to make a cash deposit, the alleged violator shall sign an appropriate statement which accompanies the citation to indicate that he or she read the statement required under this paragraph. (Ord. 406, 1989)

9.44.030 Citations issued by officers. Citations may be issued by any law enforcement officer. (Ord. 406, 1989).

9.44.040 Deposits. Deposits may be given to the Clerk of Circuit Court for Vernon County, and to the City of Viroqua police dispatcher on duty. A receipt for the deposit shall be given to the person making the deposit. (Ord. 406, 1989).

9.44.050 Bond amounts. The cash deposits which are to be required for the various ordinance violations shall be as follows:

Section/Description	Forfeiture Amount	Penalty Assessment (20%)	Automation Fee (1.00) and Court Costs (5.00)	Jail Assessment (10.00)	Bond Amount
9.06.010 Obstructing a police officer	212.50	42.50	6.00	10.00	271.00
9.10.010 Destruction of property	212.50	42.50	6.00	10.00	271.00
9.10.020 Theft	212.50	42.50	6.00	10.00	271.00
9.12.010 Public possession of open intoxicants	62.50	12.50	6.00	10.00	91.00
9.12.020 Open intoxicants in parking lot	62.50	12.50	6.00	10.00	91.00
9.12.030 Open intoxicants on business premises	62.50	12.50	6.00	10.00	91.00
9.12.102 Possession of liquor by minor	62.50	12.50	6.00	10.00	91.00
8.12.105 Misrepresentation of age – minor	62.50	12.50	6.00	10.00	91.00
9.16.030 Disorderly conduct	212.50	42.50	6.00	10.00	271.00
9.38.010 shoplifting	212.50	42.50	6.00	10.00	271.00
10.040.020 State traffic code	(As provided in the State traffic bond schedule)				
10.38.020 Tire squealing	62.50	12.50	6.00	10.00	91.00
9.26.010 Trespassing	62.50	12.50	6.00	10.00	91.00
9.14.010 Possession of marijuana	112.50	22.50	6.00	10.00	151.00
8.28.010 Storage of junked or unlicensed vehicle	47.50	9.50	6.00	10.00	73.00
6.04.010 Permitting dogs to run at large	47.50	9.50	6.00	10.00	73.00
6.04.090 Allowing dogs to disturb the peace	47.50	9.50	6.00	10.00	73.00
5.44.020 Transient merchant license required	62.50	12.50	6.00	10.00	91.00
9.10.030 Worthless checks	112.50	22.50	6.00	10.00	151.00
8.18.060 Garbage or refuse removal (a) through (c)	162.50	22.50	6.00	10.00	211.00
9.42.010 Harassment	112.50	22.50	6.00	10.00	151.00
5.20.010 Closing hours, Class B premises	212.50	42.50	6.00	10.00	271.00

(Ord 406, 1989; Ord 413, 1989)

9.44.060 Violator's options; procedure on default. (a) The person named as the alleged violator in a citation may appear in court at the time specified in the citation or may mail or deliver personally a cash deposit in the amount, within the time and to the court, clerk of court or other official specified in the citation. If a person makes a cash deposit, the person may nevertheless appear in court at the time specified in the citation, provided that the cash deposit may be retained for application against any forfeiture penalty assessment or jail assessment which may be imposed.

(b) If a person appears in court in response to a citation, the citation may be used as the initial pleading, unless the court directs that a formal complaint be made, and the appearance confers personal jurisdiction of over the person. The person may plead guilty, no contest or not guilty. If the person pleads guilty or no contest, the court shall accept the plea, enter a judgment of guilty and impose a forfeiture the penalty assessment imposed by §165.87 and the jail assessment imposed by §53.46(1). A plea of not guilty shall put all matters in the case at issue, and the matter shall be set for trial.

(c) If the alleged violator makes a cash deposit and fails to appear in court, the citation may serve as the initial pleading and the violator shall be deemed to have tendered a plea of no contest and submitted to a forfeiture the penalty assessment imposed by §165.87 and the jail assessment imposed by §53.46(1) not exceeding the amount of the deposit. The court may either accept the plea of no contest and enter judgment accordingly or reject the plea. If the court accepts the plea of no contest, the defendant may move within 10 days after the date set for the appearance to withdraw the plea of no contest, open the judgment and enter a plea of not guilty if the defendant shows to the satisfaction of the court that the failure to appear was due to mistake, inadvertence, surprise or excusable neglect. If the plea of no contest is accepted and not subsequently changed to a plea of not guilty, no costs or fees may be taxed against the violator, but a penalty assessment and a jail assessment shall be assessed. If the court rejects the plea of no contest or if the alleged violator does not make a cash deposit and fails to appear in court at the time specified in the citation, an action for collection of the forfeiture penalty assessment and jail assessment may be commenced. The citation may be used as the complaint in the action for the collection of the forfeiture penalty assessment and jail assessment. (Ord. 406, 1989).

Chapter 9.46

PROHIBITING CERTAIN ELECTRONIC MESSAGES

Section 9.46.010: Whoever repeatedly sends information to another person by electronic means with the intent to annoy, offend, demean, ridicule, degrade, belittle, disparage, or humiliate any person and which serves no legitimate purpose shall be required to forfeit not less than \$50 nor more than \$500 together with the cost of prosecution and in default of payment shall be sentenced to the County Jail until such forfeiture and costs are paid, not exceeding 30 days. (Ord. 12OR001)

Chapter 9.48

PENALTY FOR FALSE STATEMENT OR RECORD

Sections:

- 9.48.010 False statement or record – penalty
- 9.48.020 Void permit, license, or other benefit

9.48.010 Whoever makes a false statement or record which he or she knows, or in the exercise of ordinary care should know, is false, when such statement or record is authorized or required by law or is required by any public officer or governmental agency as a prerequisite to such officer or agency taking some official action, shall be required to forfeit not less than \$50 nor more than \$200 together with the costs of prosecution, and in default of payment thereof may be committed to the county jail until such forfeiture and costs are paid, not exceeding 30 days.

9.48.020 A permit, license, or other benefit issued, granted, or conferred because of a false statement or record is void.

Title 10

VEHICLES AND TRAFFIC

Chapters:

- 10.04 Traffic Code
- 10.08 Enforcement - Penalties
- 10.12 Traffic Control Devices
- 10.16 Speed Restrictions
- 10.20 Heavy Traffic
- 10.24 Through Highways
- 10.26 One Way Streets
- 10.28 Parking and abandoned vehicles
- 10.36 Accident Reports
- 10.38 Squealing Tires
- 10.40 Airport Traffic
- 10.42 Bicycles, Skateboards, Roller Skates/Skis, Play Vehicles
- 10.44 Compression Brakes
- 10.46 Neighborhood Electric Vehicles
- 10.48 Races on City Streets
- 10.50 All-Terrain Vehicles and Utility Terrain Vehicles
- 10.52 Golf Carts

Chapter 10.04

TRAFFIC CODE

Sections:

- 10.04.010 References to Statutes
- 10.04.020 State Statutes adopted by reference
- 10.04.030 State Statutes - negligent or drunken driving

10.04.010 Reference to Statutes. References to specific statutory sections, whenever used in this title, shall mean the Revised Wisconsin Statutes. (Ord. 282, 1977; Ord. 248, 1973).

10.04.020 State Statutes adopted by reference - Generally. A. Except as otherwise specifically provided in this title, all provisions of Chapters 340 to 348 of the Wisconsin Statutes, describing and defining regulations with respect to vehicles and traffic for which the penalty is a forfeiture only, including penalties to be imposed and procedure for prosecution, are adopted and by reference made a part of this title as if fully set forth in this section. Any act required to be performed or prohibited by any statute incorporated in this title by reference is required or prohibited by this title.

B. Sections of Chapters 340 to 348 of the Wisconsin Statutes, adopted by reference shall include but not be limited to the following:

340.01	Words and phrases defined
341.11(4)	Display of registration plates
341.15	Display of registration plates
341.16(4)	Issuance of duplicated plates
341.42(4)	Reciprocity permits
341.55	Penalty for misuse of plates
341.57(3)	Registration of finance companies and banks
341.63	When registration is to be suspended
342.05(4)	Certificate of title required
342.15(5), (6) and (7)	Transfer of interest in vehicle
342.23	Secured party's and owner's duties
342.30, 342.31, 342.34	ANTI-THEFT AND ANTI-FRAUD PROVISIONS
343.01	Words and phrases defined
343.305	Implied consent
343.35	Surrender of licenses upon cancellation, revocation or suspension
343.45 to 343.46	UNLAWFUL PRACTICES RELATIVE TO LICENSES
343.60 to 343.72	LICENSING OF DRIVE SCHOOLS AND INSTRUCTORS
343.73	Penalty
344.01	Words and phrases defined
344.45 to 344.47	PENALTIES FOR VIOLATION OF CHAPTER
344.51	Financial responsibility for domestic rented vehicles
345.01	Words and phrases defined
345.20 to 345.53	GENERAL PROVISIONS IN TRAFFIC FORFEITURE ACTIONS
345.55	Traffic officers not to profit from arrests
346.01	Words and phrases defined
346.02	Applicability of chapter
346.03	Applicability of rules of the road to authorized emergency vehicles.
346.04(1) and (2), 346.05 to 346.16	DRIVING, MEETING, OVERTAKING, AND PASSING
346.17	Penalty for violating Sections 346.04 to 346.16
346.18 to 346.21	RIGHT OF WAY

346.22	Penalty for violating sections 346.18 to 346.21
346.23 to 346.29	DRIVERS AND PEDISTRIANS
346.30	Penalty for violating Sections 346.23 to 346.29
346.31 to 346.35	TURNING AND STOPPING AND REQUIRED SIGNALS
346.36	Penalty for violating Sections 346.31 to 346.35
346.37 to 346.42	TRAFFIC SIGNS, SIGNALS AND MARKINGS
346.43	Penalty for violating Sections 346.37 to 346.42
346.44 to 346.48	REQUIRED STOPS
346.49	Penalty for violating Sections 346.44 to 346.48
346.50 to 346.55	RESTRICTIONS ON STOPPING AND PARKING
346.56	Penalty for violating Sections 346.50 to 346.55
346.57(2), (3) and (4)(a) to (c)	SPEED RESTRICTIONS – first offense in a year
346.57(4)(d), (5) and (6) to 346.595	SPEED RESTRICTIONS
346.60	Penalty for violating Sections 346.57 to 346.595
346.61	Applicability of sections relating to reckless and drunken driving
346.62(1) and (3)	Reckless driving – first offense in four years
346.63(1), (3) and (4)	Operating under “influence” of intoxicant – first offense in five years
346.64	Employment of drunk operators – first offense in a year
346.65(1) and (2)	Penalty for violating Sections 346.62 to 346.64
346.66	Applicability of sections relating to accident and accident reporting
346.68 and 346.69	Duty upon striking unattended vehicle – upon striking property on or adjacent to highway – first offense within a year
346.70(1), (2) or (3), 346.71, 346.72, 346.73	Duty to report accident, etc.
346.70(4)	Police and traffic agencies to report
346.70(5)	Falsifying reports – first offense within a year
346.77 to 346.81	BICYCLES AND PLAY VEHICLES
346.82	Penalty for violating Sections 346.77 to 346.81
346.87 to 346.94	MISCELLANEOUS RULES
346.95	Penalty for violating Sections 346.87 to 346.94

347.01 to 347.05	GENERAL PROVISIONS
347.06 to 347.29	LIGHTING EQUIPMENT
347.30	Penalty for violating lighting equipment requirements
347.35 to 347.49	OTHER EQUIPMENT
347.50	Penalty for violating Sections 347.35 to 347.49
348.01 to 348.02	SIZE, WEIGHT, LOAD – General provisions
348.05 to 348.10	SIZE AND LOAD
348.11	Penalty for violating size and load limitations
348.15 to 348.20	WEIGHT
348.21	Penalty for violating weight limitations
348.25 to 348.27	PERMITS
348.28	Permits to be carried – PENALTY

(Ord. 248 §1(1), 1973).

10.04.030 State statutes adopted by reference – Negligent or drunken driving. There are adopted by reference the following sections of the Wisconsin Statutes, but the prosecution of such offenses under this title shall be as provided in Chapters 340 to 348 of the Wisconsin Statutes, and the penalty for violation thereof shall be limited to a forfeiture as provided in Section 10.08.070.

942.01(1)	Negligent operation of vehicle off highway
947.045	Drinking in motor vehicle on highway

(Ord. 248 §1(2), 1973).

Chapter 10.08

ENFORCEMENT – PENALTIES

Sections:

10.08.010	Enforcement – Generally
10.08.020	Enforcement – Stipulation of guilt or no contest – Permissible when
10.08.030	Enforcement – Stipulation of guilt or no contest – Deposits
10.08.040	Enforcement – Receipt of moneys by officer – Recordkeeping duty
10.08.050	Enforcement – Receipt of moneys by officer – Delivery – Oath
10.08.060	Penalty – Generally
10.08.070	Penalty – Uniform offenses
10.08.080	Penalty – Offenses generally

10.08.010 Enforcement – Generally. This title shall be enforced in accordance with the provisions of Sections 345.20 to 345.53, Chapter 299, and Section 66.12 of the Wisconsin Statutes. (Ord. 248 §8 (part), 1973).

10.08.020 Enforcement – Stipulation of guilt or no contest – Permissible when. Stipulations of guilt or no contest may be made by persons arrested for violations of this title, in accordance with Section 66.12(1)(b) of the Wisconsin Statutes, whenever the provisions of Section 345.27 are inapplicable to such violations. Stipulations shall conform to the form contained on the uniform traffic citation and complaint under Section 345.11 of the Wisconsin Statutes, and may be accepted within five days of the date of the alleged violation. Stipulations may be accepted by the police department. (Ord. 248 §8(1), 1973).

10.08.030 Enforcement – Stipulation of guilt or no contest – Deposits. Any person stipulating guilt or no contest under Section 10.08.020 must make the deposit required under Section 345.26 of the Wisconsin Statutes or, if the deposit is not established under such statute, shall deposit a forfeited penalty as provided in the schedule established by the chief of police and approved by the Council. Deposits may be brought or mailed to the office of the municipal justice as directed by the arresting officer. Deposits for parking or nonmoving violations shall be mailed or brought to the police department. (Ord. 248 §8(2), 1973).

10.08.040 Enforcement – Receipt of moneys by officer – Recordkeeping duty. Every officer accepting a forfeited penalty or money deposit under this title shall receipt therefor in triplicate as provided in Section 356.26(3)(b) of the Wisconsin Statutes. Every officer accepting a stipulation under the provisions of this title shall comply with the provisions of Sections 343.27, 343.28, 345.26(1)(a) and 345.27 of the Wisconsin Statutes, and shall require the alleged violator to sign a statement of notice in substantially the form contained on the uniform traffic citation and complaint promulgated under Section 345.11 of the Wisconsin Statutes. (Ord. 248 §8(3), 1973).

10.08.050 Enforcement – Receipt of moneys by officer – Delivery – Oath. Any officer accepting deposits or forfeited penalties under this title shall deliver them to the city treasurer - assessor within twenty days after receipt. Any officer authorized to accept deposits under Section 345.26 of the Wisconsin Statutes or this title shall qualify by taking the oath prescribed by Section 19.01 of the Wisconsin Statutes and filing an official bond of one thousand dollars as described by Section 19.01 of the Wisconsin Statutes. (Ord. 248 §8(4), 1973).

10.80.060 Penalty – Generally. The penalty for violation of any provision of this title shall be a forfeiture, as provided in Sections 10.08.040 and 10.08.050, together with the cost of prosecution imposed as provided in Sections 345.20 to 345.53 of the Wisconsin Statutes. (Ord. 248 §7 (part), 1973).

10.08.070 Penalty – Uniform offenses. Forfeitures for violation of any provision of Chapters 341 to 348 of the Wisconsin Statutes adopted by reference in Sections 10.04.020 and 10.04.030 shall conform to forfeitures for violation of the comparable state offense, including any variations or increases for second offenses. (Ord. 248 §7(1), 1973).

10.08.080 Penalty – Offenses generally. The forfeiture for violation of Sections 10.12.010, 10.12.020, 10.16.010, 10.24.010, 10.28.010, through 10.28.070, and 10.36.010 shall not be less than five dollars nor more than two hundred dollars for the first offense and not less than ten dollars for each separate offense; except that the amount of forfeiture for violations of this title pertaining to overtime parking shall be one dollar if paid within twenty - four hours of said violation and two dollars if paid more than twenty -four hours after such violation. (Ord. 257 §3, 1974; Ord. 248 §7(2), 1973).

Chapter 10.12

TRAFFIC-CONTROL DEVICES

Sections:

- 10.12.010 Street commissioner’s duty to procure, erect and maintain.
- 10.12.020 Prohibited placement – Removal.
- 10.12.030 Barriers or signs – Prohibited removal or entry – Violation – Penalty.
- 10.12.040 School bus warning lights.

10.12.010 Street commissioner’s duty to procure, erect and maintain. The street commissioner is authorized and directed to procure, erect and maintain appropriate standard traffic signs, signals and markings, conforming to the rules of the state highway division, giving such notice of the provisions of this title as required by state law. Signs shall be erected in such locations and manner as the street commissioner determines will best effect the purposes of this title and give adequate warning to users of the street or highway. (Ord. 248 §6(1), 1973).

10.12.020 Prohibited placement – Removal. The street commissioner shall have the authority granted by Section 349.09 of the Wisconsin Statutes and is directed to order the removal of a sign, signal, marking or device placed, maintained or displayed in violation of this title or Section 346.41 of the Wisconsin Statutes. Any charge imposed on a premises for removal of such an illegal sign, signal or device shall be reported to the Council at its next regular meeting for review and certification. (Ord. 248 §6(2), 1973).

10.12.030 Barriers or signs – Prohibited removal or entry – Violation – Penalty. Any person who removes any barrier or sign erected for the purpose of prohibiting traffic on any street, or who enters upon or traffics over and upon any such street so closed, shall be punished by a fine not to exceed one hundred dollars. (Ord. 281 §9, 1977; Ord. 60 §1, 1922).

10.12.040 School bus warning lights. Flashing red warning lights shall be used by school bus operators in a residence or business district when pupils or other authorized passengers are to be loaded or unloaded at a location at which there are no traffic signals and such persons must cross the street or highway before being loaded or after being unloaded. (Ord. 317 §1, 1981).

Chapter 10.16

SPEED RESTRICTIONS

Sections:

- 10.16.010 Speed limits – Increases.
- 10.16.015 Speed limits – Decreases.
- 10.16.020 Speed limits – Decreases.

10.16.010 Speed limits – Increases. The Council determines that the statutory speed limits on the following streets or portions thereof are unreasonable, unsafe or imprudent and modifies such speed limits under authority granted by Section 349.11 of the Wisconsin Statutes as follows: Speed limits established by Section 346.57(4)(e), (f) and (g) of the Wisconsin Statutes are increased upon the following streets or portions thereof:

- A. Forty-five miles per hour on South Main Street from the south city limits to two hundred feet east of Rusk Avenue;
- B. Thirty-five miles per hour on South Main Street from two hundred feet east of Rusk Avenue to two hundred feet south of Maple Street;

C. Fifty miles per hour on North Main Street from the intersection of County Highway "BB" to one thousand feet south of such intersection;

D. Forty miles per hour on North Main Street from one thousand feet south of the intersection of County Highway "BB" to the entrance to the county fair grounds. (Ord. 248 §2, 1973).

10.16.015 Speed limits – Decreases. The Council determines that the speed limit on the following street or portion thereof, should conform to Section 346.57(4)(e) of the Wisconsin Statutes, being the speed limit of: "25 miles per hour on any highway within the corporate limits of a city or village, other than on highways and outlying districts in such city or village," pursuant to the authority of Section 349.11, Wisconsin Statutes, said street being as follows: West Broadway, from the intersection with Highway 14 to the intersection of the street into Abbey Estates. (Ord. 306 §1, 1980).

10.16.020 Speed limits - Decreases. The Council determines that the statutory speed limit on the following streets is greater than is reasonable or safe and modifies statutory speed limits pursuant to Section 349.11 and 346.57, Stats., and establishes the speed limits of 15 mph on the following streets or portions thereof:

A. All of the streets in Westview Mobile Home Park;

B. All of the streets in the Vernon Estate Mobile Home Park;

C. That part of Rock Street adjacent to the Municipal Pool and recreation area when children are going to or from or are playing within such area. (Ord. 365, S. 1, 1984; Ord. 248A, S.1, 1973; Ord. 248, S.2, 1, 1973).

D. Lewison Lane adjacent to the Washington Street playground shall be 15 miles per hour when children are present. (Ord. 497, 1999)

Chapter 10.20

HEAVY TRAFFIC

Sections:

- 10.20.01 0 Definitions
- 10.20.020 Heavy traffic routes designated; exceptions
- 10.20.030 Heavy traffic route signs

10.20.010 Definition. In this Chapter, "heavy traffic" means all vehicles not operating completely on pneumatic tires and all vehicles or combination of vehicles, other than motor busses, designed or used for transporting property of any nature and having a gross weight of more than 26,000 pounds, but does not include City-owned motor vehicles, and does not include motor vehicles responding to an emergency. (Ord 08OR011)

10.20.020 Heavy traffic routes designated; exceptions. Heavy traffic is prohibited in the City except on State Trunk Highway 56, US Highway 14/61, Fairlane Drive, and that part of County Trunk Highway BB within the City, and those parts of County Trunk Highways NN and SS within the City, but this shall not prohibit heavy traffic from using other streets but only for the purpose of moving or delivering supplies or commodities to or from any place of business or residence which has an entrance on such street. (Ord 08OR011)

10.20.030 Heavy traffic route signs. The heavy traffic route shall be designated by appropriate signs to be erected giving notice thereof. (Ord 08OR011)

Chapter 10.24

THROUGH HIGHWAYS

Sections:

- 10.2 4.010 Designated.
- 10.24.020 Chief of Police may designate.
- 10.24.030 Traffic by Municipal Pool.
- 10.2 4.031 Chicago Avenue
- 10.24.032 Certain intersections with Chicago Avenue
- 10.24.033 Certain intersections on Rusk Avenue

10.24.010 Designated.

A. In the interest of public safety and pursuant to Section 349.07 of the Wisconsin Statutes, the following street or portions thereof are declared to be through highways, and traffic signs or signals giving notice thereof shall be erected by the City in accordance with Chapter 10.12:

1. Main Street and South Highway 14 from the north City limits to the south City limits;
2. Decker Street from the east City limits to the west City limits;
3. Jefferson Street between the east side of East Avenue and the west side of Rock Street;
4. Rock Street between the north side of South Street and the south side of Jefferson Street, and between the north side of Jefferson Street and the south side of Decker Street, and between the north side of Decker Street and the south side of Broadway;
5. West South Street;
6. West Broadway;
7. East Broadway;
8. East Terhune Street;
9. East South Street;
10. East Linton Street, except as provided in subsection M of this section;
11. West Maple Street.

B. Traffic approaching South Washington Avenue from Coe Court shall stop at the east limit of South Washington.

C. Traffic approaching East Avenue from Walnut Street shall stop at the east limit of East Avenue.

D. Traffic approaching Lincoln Avenue from Terhune Street shall stop at the west limit of Lincoln Avenue.

E. Traffic approaching East Avenue from Gillette Street shall stop at the west limit of East Avenue.

F. Traffic on East Avenue shall stop before entering East Linton Street.

G. Traffic going westerly on West Decker shall stop at the east limit of Hillyer Street before crossing Hillyer Street entering the school property.

H. Traffic going westerly on old Highway 14 past the Great Rivers FS Cooperative mill shall stop before entering South Main Street.

I. Traffic from Birchwood Lane shall stop before entering West South Street.

J. Traffic on West Gillette Street shall stop before entering North Dunlap Street.

K. Traffic on East Court Street shall stop before entering Lincoln Avenue.

L. Traffic from Dyson Street and from Fairview Lane and from Sherry Lane shall stop before entering Northeast Avenue.

M. Traffic on East Linton Street shall stop before entering Rusk Street.

N. Traffic from Dairyland Hills Subdivision shall stop before entering South Street and before entering Sidie Hollow Road.

O. Traffic on Rock Street shall stop before entering the intersection with Oak Street.

P. Traffic on Williams Street shall stop before entering the intersection of Western Avenue.

Q. Traffic on Conner Street shall stop before entering the intersection of Western Avenue.

- R. Traffic on Bekkedal Court shall stop before entering the intersection with West Broadway.
- S. Traffic on Willow shall stop before entering the intersection with South Main Street.
- T. Traffic on Sunset Street shall stop before entering the intersection with South Main Street.
- U. Traffic on Heritage Street shall stop before entering the intersection with Western Avenue. (Ord. 373; Ord. 370; Ord. 367; Ord. 363; Ord. 358; Ord. 351; Ord. 274; Ord. 259; Ord. 248)

10.24.020 Chief of Police may designate. On and after August 1, 1988, the Chief of Police of the City may prohibit, limit the time of or otherwise restrict the stopping, standing or parking of vehicles, by official traffic signs or markings. (Ord. 402, 1988).

10.24.030 Motor Vehicle Traffic by the Municipal Pool. Motor vehicle traffic by the Municipal Pool, on South Rock Avenue, shall obey any official stop or yield sign or speed limit sign placed in the street by resolution of the Public Safety Committee or by direction of the Chief of Police. (Ord. 454, 1995).

10.24.031 Chicago Avenue. Motor vehicles shall stop at the intersection of the following streets and Chicago Avenue;

- (a) Traffic eastbound on Airport Lane.
- (b) Traffic eastbound on Sands Road.
- (c) Independence Street.

10.24.032 Certain intersections with Chicago Avenue. Motor vehicles on the following streets shall stop at the intersection of Chicago Avenue: (Ord. 491, 1999)

- (a) Chase Street.
- (b) Connor Street.
- (c) Williams Street.

10.24.033 Certain intersections on Rusk Avenue. Motor vehicles shall stop at the following intersections ("four way stop"): Rusk Avenue with East Hickory Street; and Rusk Avenue with East Oak Street.

Chapter 10.26ONE WAY STREETSSections:

- 10.26.010 East Court Street
 10.26.020 West Court Street

10.26.010 East Court Street. Motor vehicles and bicycles shall travel only in an Easterly direction on that part of East Court Street between Main and Center streets. (Ord. 400, 1988).

10.26.020 West Court Street. Motor vehicles and bicycles shall travel only in a Westerly direction on that part of West Court Street between Main and Rock Streets. (Ord. 400, 1988).

Chapter 10.28PARKINGSections:

- 10.28.010 Limits Generally
 10.28.020 Prohibited Parking
 10.28.030 Limited Through Streets
 10.28.040 Winter Snow Event
 10.28.050 Temporary Parking Restrictions
 10.28.060 48-Hour Parking Limitation
 10.28.070 Dumpsters
 10.28.080 Trailers, Boats and Campers
 10.28.090 Parking of Certain Commercial Vehicles Restricted
 10.28.100 Removal of Illegally Parked Vehicles
 10.28.110 Abandoned Vehicles – Municipal Parking Lots – Nuisance
 10.28.120 Abandoned Vehicles – Highways, Public or Private Property – Nuisance
 10.28.130 Abandoned Vehicles – Junked
 10.28.140 Abandoned Vehicles – Notice and Disposal
 10.28.150 Penalties

10.28.010 Limits generally.

A. To the extent allowed by law, the Public Works Director or the City Police Chief may prohibit, limit the time of or otherwise restrict the stopping, standing or parking of vehicles, by official traffic signs, meters or markings in accordance with Wis. Stat. §349.13(1e)(c).

B. The following days are considered legal holidays for the purpose of parking restrictions: New Year's Day, Memorial Day, Independence Day, Labor Day, Thanksgiving Day and Christmas Day.

C. All vehicles shall park parallel to and within one foot of the curb except where streets are marked for angle parking.

D. No person shall intentionally obliterate or obscure any marking or device used by the City in measuring the amount of time that vehicles are parked.

E. No person, other than the vehicle owner or operator, shall remove a City parking citation from a motor vehicle.

10.28.020 Prohibited parking. Except temporarily for the purpose of and while actually engaged in loading or unloading or in receiving or discharging passengers or property and while the vehicle is attended by a licensed operator so that it may be moved promptly in case of an emergency or to avoid obstruction of traffic, no person shall at any time park or leave standing any vehicle:

- A. Within an intersection.
- B. On a crosswalk.
- C. On a sidewalk.
- D. On the roadway side of any parked vehicle, unless double parking is clearly indicated by official traffic signs or markers.
- E. Within twenty (20) feet of the driveway entrance to a fire station.
- F. Upon any portion of a highway where and at the time when stopping or standing is prohibited by official traffic signs indicating the prohibition of any stopping or standing.
- G. In any place or manner so as to obstruct, block or impede traffic.
- H. Within 10 feet of a fire hydrant, unless a greater distance is indicated by an official traffic sign.
- I. Upon any portion of a highway where and at the time when parking is prohibited, limited or restricted by official traffic signs.
- J. Upon any street or highway within the City limits any vehicle which faces a direction different from the direction of normal traffic flow for the lane of traffic in which said vehicle is stopped or standing.

- K. In a loading zone.
- L. Within four feet of the entrance to an alley, private road or driveway.

10.28.030 Limited Through Streets. The Council from time to time may designate streets or portions thereof as limited through streets, and traffic entering such streets shall yield the right-of-way to traffic travelling upon such streets. (Ord 196 §13 (part), 1978; Ord. 248 §4 (1) (part), 1973).

10.28.040 Winter Snow Event. In the event of a snowfall of one and a half inches (1 ½ inches) or more, the Director of Public Works or City Police Chief, or their designees, may declare a "Winter Snow Event." When a winter snow event is declared the following parking restrictions shall apply:

A. In the Haul Zone, parking shall be prohibited on any City street or alley between the hours of midnight until 7 a.m. until that street or alley has been plowed and the snow has been removed past the curblin to the sidewalk. The Haul Zone is defined as all of Highway 14/Main Street, the area including and bounded to the north by Decker Street/Highway 56, to the south by South Street, to the west by Dunlap Street, and to the east by Center Street.

B. In all other areas, parking on City streets and alleys shall be prohibited until that street or alley has been plowed and the snow has been removed to the curblin.

10.28.050 Temporary Parking Restrictions

A. Street Maintenance. Whenever it is necessary to clear or repair a city street, alley or any part of the street right-of-way, the Public Works Director or City Police Chief shall post "No Parking" signs at least two hours prior to the time that street maintenance work is to be commenced. No person shall park a motor vehicle in violation of such signs.

B. Special Events. Pursuant to the provisions of Wis. Stat. §349.13, the City Police Chief, or their designee, may direct that "No Parking" signs be erected during parades, festivals and other authorized events that require the regulation of vehicle stopping, standing or parking on City streets or alleys. The temporary regulation shall be limited to the time the event exists or is likely to exist.

C. Snow Removal. No person shall park, place or leave standing any automobile, truck or other vehicle on any City street or alley from one hour after the time such area has been designated and marked with signs or barriers by the City Police Department or Public Works Department until said signs or barriers are removed.

10.28.060 48-Hour Parking Limitation.

A. No person, firm or corporation shall park or leave standing any automobile, truck, tractor, trailer or vehicle of any description on any City Street or Alley or in any public parking lot in the City for a period of forty-eight (48) or more consecutive hours in the same location, except that where more restrictive parking restrictions have been established the more restrictive limits shall apply.

10.28.070 Dumpsters.

A. No person shall place a dumpster on any City street, alley or other public place within the City of Viroqua without first obtaining a permit from the Office of the City Clerk.

B. Any person desiring to obtain a Dumpster Permit shall pay an application fee of \$10 and provide the following information to the City Clerk:

1. The address where said dumpster shall be placed and the exact location of placement at said address.
2. The name, address and telephone number where the applicant may be reached during the time of placement of said dumpster.
3. The precise dates of placement of said dumpster, which should not exceed seven (7) days. In the event extenuating circumstances require the dumpster to be there longer than seven (7) days, the applicant must submit an explanation as to why a longer timeframe is necessary. The decision to allow the dumpster to be placed for any period longer than seven (7) days is at the discretion of the City Police Chief or their designee.

C. Applications must be received at least forty-eight (48) hours ahead of dumpster arrival, excluding weekends and holidays.

D. Upon receipt of an application by the City Clerk, a copy of the application shall be sent to the City Police Chief, or their designee, for approval of the location. In the event the City Police Chief, or their designee, has reasonable concern for public safety in the location designated, he or she shall notify the applicant that the location is considered unsuitable. Applicants may reapply within seven (7) days to place the dumpster in a different location without paying the application fee.

E. No dumpster may be placed on any City street, alley or other public place without either of the following:

1. Reflective barricades clearing marking the location of the dumpster. One barricade shall be placed in front of the dumpster and one barricade shall be placed behind the dumpster; or
2. Reflective tape in a sufficient amount that the dumpster can be easily seen during the day or night, both on the front and back of the dumpster.

10.28.080 Trailers, Boats and Campers. No person shall leave a boat, camper, motorhome or trailer standing upon any City street, alley or public parking lot in the City of Viroqua for storage purposes. Storage is defined as leaving a boat, camper, motorhome or trailer standing on any City street, alley or public parking lot for a continuous period of forty-eight (48) hours or more.

10.28.090 Parking of Certain Commercial Vehicles Restricted. No person owning or having control of any truck, trailer, truck power unit, tractor, bus or recreational vehicle in excess of 10,000 pounds gross weight or over 16 feet in length, or having an enclosed height of more than eight feet from the roadway shall park the same upon any City street or alley in any residential zone in the City between the hours of 6:00 p.m. and 7:00 a.m. One-hour parking will be allowed in residential zones between 7:00 a.m. and 6:00 p.m. The provisions of this subsection shall not be deemed to prohibit the lawful parking of such equipment upon any City street or alley for the actual loading or unloading of goods, ware or merchandise, providing, however, that the "loading" and "unloading" shall be limited to the actual time consumed in such operation. The City Council may, however, designate specific truck parking zones.

10.28.100 Removal of Illegally Parked Vehicles.

A. Hazard to public safety. Any vehicle parked, stopped or standing upon a City street, alley or public parking lot in violation of any of the provisions of this chapter is declared to be a hazard to traffic and public safety.

B. Removal by operator. Such vehicle shall be removed by the operator in charge, upon request of any City police officer, to a position where parking is permitted or to a private or public parking or storage premises.

C. Removal by City police officer. Any City police officer after issuing a citation for illegal parking, stopping or standing of an unattended vehicle in violations of this Chapter, is authorized to remove such vehicle to a position where parking is permitted.

D. Removal by private service. The City police officer may order a motor carrier holding a permit to perform vehicle towing services, a licensed motor vehicle salvage dealer or a licensed motor vehicle dealer who performs vehicle towing services to remove and store such vehicle in any public storage garage or rental parking grounds or any facility of the person providing the towing services.

E. Towing and storage charges. In addition to other penalties provided in this chapter, the owner or operator of a vehicle so removed shall pay the actual cost of moving, towing and storage. If the vehicle is towed or stored by a private motor carrier, motor vehicle salvage dealer or licensed motor vehicle dealer, actual charges regularly paid for such services shall be paid. If the vehicle is stored in a public storage garage or rental facility, customary charges for such storage shall be paid. Upon payment, a receipt shall be issued to the owner of the vehicle for the towing or storage charge.

10.28.110 Abandoned vehicles – Municipal parking lots – When designated nuisance. Any vehicle parked and left standing in any municipal parking lot in the city in excess of a continuous period of forty-eight hours, in violation of Section 10.28.060, shall be deemed to be abandoned and shall constitute a public nuisance.

10.28.120 Abandoned vehicles – Highways, public or private property – When designated nuisance. No person shall leave unattended any motor vehicle, trailer, semitrailer or mobile home on any public highway or private or public property, for such time and under such circumstances as to cause the vehicle to reasonably appear to have been abandoned. Except as otherwise provided in this section, whenever any vehicle has been left unattended without the permission of the property owner for more than forty-eight hours, the vehicle is deemed abandoned and constitutes a public nuisance. A motor vehicle shall not be considered an abandoned motor vehicle when it is out of ordinary public view or when designated as not abandoned by the chief of police. (Ord. 361 §1 (part), 1984).

10.28.130 Abandoned vehicles – when junked. Any vehicle in violation of this section shall be impounded until lawfully claimed or disposed of under Section 10.28.140; except that if it is deemed by the chief of police that the cost of towing and storage charges for the impoundment would exceed the value of the vehicle, the vehicle may be junked or sold by the city prior to expiration of the impoundment period upon determination by the chief of police that the vehicle is not stolen or otherwise wanted for evidence or other reason. All substantially complete vehicles in excess of nineteen model years of age shall be disposed of in accordance with Section 10.28.140. (Ord. 361 §1 (part), 1984).

10.28.140 Abandoned vehicles – Notice and disposal. Any vehicle which is deemed abandoned and not disposed of under Section 10.28.130 shall be retained in storage for a minimum period of ten days after certified mail notice has been sent to the owner and lienholders of record to permit reclamation of the vehicle after payment of accrued charges. Such notice shall set forth the year, make, model, and serial number of the abandoned motor vehicle, the place where the vehicle is being held, and shall inform the owner and any lienholder of their right to reclaim the vehicle. The notice shall state that the failure of the owner or lienholders to exercise their rights to reclaim the vehicle under this section shall be deemed a waiver of all right, title, and interest in the vehicle and a consent to the sale of the vehicle. Each retained vehicle not reclaimed by its owner or lienholder may be sold. The city may dispose of the vehicle by sealed bid or auction sale, and at such sale the highest bid for any such vehicle shall be accepted unless the same is deemed inadequate by the chief of police, in which event all bids may be rejected. If all bids are rejected or no bid is received, the city may either readvertise the sale, adjourn the sale to a definite date, sell the motor vehicle at a private sale, or junk the vehicle. Any interested person may offer bids on each abandoned vehicle to be sold. A public notice shall be posted at the office of the city police department and the courthouse. Upon sale of an abandoned vehicle, the city shall supply the purchaser with a completed form designed by the Department of Transportation enabling the purchaser to obtain a certificate of title for the vehicle. The purchaser shall have ten days to remove the vehicle from the storage area, but shall pay a reasonable storage fee established by the city for each day the vehicle remains in storage after the second business day subsequent to the sale date.

Ten days after the sale, the purchaser shall forfeit all interest in the vehicle and the vehicle shall be deemed to be abandoned and may be sold again. Within five days after the sale or disposal of a vehicle as provided in this section, the city shall inform the Department of Transportation of the sale or disposition on my forms provided for that purpose by the Department. The owner of any abandoned vehicle except a stolen vehicle is responsible for the abandonment and all costs of impounding and disposing of the vehicle. Costs not recovered from the sale of the vehicle may be recorded in a civil action by the city against the owner. (Ord. 361 §1 (part), 1984).

10.28.150 Penalties. The penalty for violation of the provisions of this Chapter shall be \$20 if paid within ten (10) days of the date of issuance of the citation, together with costs of prosecution. The penalty for any citation not paid within ten (10) days of issuance shall increase to \$40, together with the costs of prosecution. The penalty for any citation unpaid after sixty (60) days shall increase to \$76.20, together with the costs of prosecution, and the vehicle owner's license plates shall be suspended. Penalties assessed shall be in addition to any costs of removal and/or storage as provided for in this Chapter. In default of payment of same, violators shall be committed to the county jail until such forfeiture and costs are paid, not to exceed thirty (30) days.

Chapter 10.36

ACCIDENT REPORTS

Sections:

10.36.010 Responsibility of operator or rider.

10.36.010 Responsibility of operator or rider. The operator of any vehicle involved in an accident shall within ten days after such accident file with the police department a copy of the report required by Section 346.70 of the Wisconsin Statutes, if any. If the operator is unable to make such report, any occupant of the vehicle at the time of the accident capable of making such report shall have the duty to comply with this section. Such reports shall be subject to the provisions and limitation in Sections 346.70(4)(f) and 346.73 of the Wisconsin Statutes. (Ord. 248 §5, 1973).

Chapter 10.38SQUEALING TIRESSections:

- 10.38.010 Council's findings
- 10.38.020 Squealing tires prohibited
- 10.38.030 Penalty.

10.38.010 Council's findings. The Common Council finds and determines that in the normal and prudent operation of a motor vehicle no sound or noise is audible from vehicle tires running on pavement, and that in those instances when a squealing noise is audible, such sound or noise is caused by rapid acceleration, excessive speed at corners, or application of brakes in a manner causing the tires to skid on pavement. (Ord. 302 §1 (part) 1979).

10.38.020 Squealing tires prohibited. No person shall operate a motor vehicle in a manner which causes the tires to squeal. (Ord. 302 SS1 (part), 1979)

10.38.030 Penalty. Any person who intentionally violates Section 10.38.020 shall, upon conviction, be required to forfeit not less than twenty-five dollars nor more than one hundred dollars, together with costs, and in default in payment thereof, shall be committed to the county jail until said forfeiture and costs are paid, not exceeding thirty days. (Ord. 302 SS1 (part), 1979).

Chapter 10.40VIROQUA AIRPORTSections:

- 10.40.010 Definitions
- 10.40.020 Airport operation policies
- 10.40.025 Parking and pedestrians at airport
- 10.40.030 Hangar use
- 10.40.040 Severability
- 10.40.050 Violation – penalty

10.40.010. Definitions.

- A. Airport – The Viroqua Municipal Airport.
- B. Airport Hazard – Any structure, natural or manmade, that may obstruct the airspace required for taking off or landing of aircraft at the airport.

C. Owner – The City of Viroqua, Wisconsin.

D. Fixed Base Operator, normally called “FBO” – Any person, firm, business or corporation or association that provides aeronautical services, that may include, but is not limited to: Repair and maintenance of aircraft, sale of fuel for aircraft, flight instruction, carrying of property or persons for hire, sale of aircraft supplies, and operates out of a building or hangar for that purpose at the airport.

E. Private Hangar – A building housing one or more aircraft for the personal or business use of the hangar owner or lessee.

F. Commission – A group of five persons, appointed by the City, which has jurisdiction for the construction, improvement, equipment maintenance and operation of the airport, formally known as the Airport Commission.

G. Emergency Equipment – Crash, fire and rescue, police motor vehicles, and any other equipment that may be designated by the Commission or airport manager as necessary to safeguard runways, taxiways, ramps, buildings and other property.

H. Vehicle – Any device in, upon or by which any person or property is or may be transported or drawn, except aircraft.

I. Shop – A building capable of housing one or more aircraft while such aircraft are being repaired.

J. Administration building – Any building constructed and used for the sole purpose of housing office space used in the management and operation of the airport by the Commission, or other entity so designated by the Commission. (Ord. 427, 1991).

10.40.020: Airport Operation Policies. The Commission, in carrying out its duties and responsibilities shall adhere to the following policies:

A. The owner shall refrain from engaging in any activity or service, excluding airport maintenance, that could be provided by private enterprise through proper lease agreement.

B. The owner shall encourage the development of the airport by providing long term leases of land for hangars, or land for other building construction that may be approved.

C. All building plans, hangar or otherwise, must be submitted for approval to the Commission.

D. All fuel storage and dispensing equipment shall be located in the designated fuel farm area.

There shall be no fuel storage in hangars or other buildings except in the standard tanks of the aircraft in those buildings.

E. No building or structure, hangar or otherwise, shall extend more than thirty five (35) feet above the ground.

10.40.025 Parking and Pedestrians at Airport.

A. No person shall park a vehicle, nor shall the owner of a vehicle allow the same to be parked, at the Viroqua Municipal Airport except as permitted by the manager or other designee of the Viroqua Airport Commission. The Commission may establish a parking fee.

B. No vehicle shall enter, drive upon, or operate upon any airport runway, ramp, or tie-down area, apron, taxiway, or any area posted by signs prohibiting the entrance thereon, except as follows:

(1) The above restrictions shall not apply to emergency equipment, service, maintenance and construction equipment, when engaged in performing their normal duties.

(2) Aircraft owners may drive their vehicle to reach their aircraft in a tie-down area, or at their owned or leased hangar, providing such entry does not interfere with the movement of aircraft. Aircraft owners shall not leave vehicles parked in any area around hangars that may interfere with the movement of emergency vehicles.

C. No pedestrian shall be allowed beyond the administration area or upon the aircraft ramp or apron or tie-down area, unless for the purpose of embarking or disembarking from an aircraft, or unless authorized by the Commission or the airport manager. Pedestrian traffic is prohibited on runways, taxiways and outlying areas of the airport, except for those employees of the City of Viroqua, State of Wisconsin, Federal Government, or contractors engaged in airport construction or maintenance work.

10.40.030. Hangar Use. Any building constructed on the airport and designated as an aircraft hangar must be used for the housing of aircraft as the number one priority. Any hangar owner shall not make the building unavailable for aircraft, through such means as unrealistic rental fees or unrealistically high sale price.

Any such policies by any hangar owner may result in the terminations of the owners land lease. (Ord. 427, 1991).

10.40.040. Severability. The several provisions of this ordinance shall be deemed severable, and it is expressly declared that the owner would have passed the other provisions of this ordinance, irrespective of whether or not one or more provision may be declared invalid.

And, if any provision of this ordinance or the application thereof to any person or circumstances is held invalid, the remainder of the ordinance and the application of such provisions to other persons or circumstances shall not be affected thereby. (Ord. 427, 1991).

10.40.050. Violation – Penalty. Any person who violates any provision of this ordinance shall be required to forfeit not less than \$50.00 nor more than \$500.00, together with the costs of prosecution, and in default of payment of said forfeiture and costs shall be incarcerated in the county jail until said forfeiture and costs are paid, not exceeding 30 days. The City and the Airport Commission may restrain a violation or threatened violation of this ordinance. (Ord. 427, 1991).

Chapter 10.42

BICYCLES, SKATEBOARDS, ROLLER SKATES/SKIS, PLAY VEHICLES

Sections:

- 10.42.010 Regulation of bicycles.
- 10.42.020 Regulation of skateboards, roller skates, roller skis, play vehicles.
- 10.42.030 Regulation on certain sidewalks.
- 10.42.040 Violation – Penalty.

10.42.010 Regulation of bicycles. A. It shall be unlawful for any person the age of 10 or older to operate or ride a bicycle on any sidewalk in the City of Viroqua except to cross a sidewalk to enter a street or private property.

B. From and after August 1, 1990, it shall be unlawful for any person who is a resident of the City to operate a bicycle in the City of Viroqua without a license issued by the City. A bicycle license issued by the City shall be valid so long as the same is not obliterated or otherwise rendered illegible. A bicycle without a license after August 1, 1990, may be impounded until a license has been paid for and issued.

10.42.020 Regulation of skateboards, roller skates, roller skis or play vehicles. It shall be unlawful for any person to operate or ride on any skateboards, roller skates, roller skis or play vehicles as defined in Sec. 340.01, Wis. Stats., within the City of Viroqua in any of the following places:

(a) On any street or sidewalk within the following zone: Commencing at the Northeast corner of property now occupied by Hardees; thence West along the North line thereof to the NW corner thereof; thence South along the West line of the Hardee property to the Section 30 section line; thence West on the section line to a point intersecting Chicago Avenue extended; thence South along Chicago Avenue to the Northern-most corner of the

Noggle Addition; thence Southeast along the Northeast line of the Noggle Addition, and along the Northeast boundary of the Noggle Addition to Rock Street extended; thence South on Rock Street to Broadway; thence West on Broadway to Dunlap extended North; thence South on Dunlap extended North and Dunlap to Oak Street; thence East along Oak Street to Main Street; thence South on Main Street to Maple Street; thence East on Maple Street to Center Avenue; thence North on Center to Court Street; thence East on Court Street to Rusk Avenue; thence North on Rusk Avenue to Broadway Street; thence West on Broadway Street to Center Avenue; thence North on Center Avenue to the Fairgrounds; thence West to Main Street; thence North on Main Street to a point East of the Northeast corner of the Hardee property; thence West to the point of beginning.

(b) In or on any municipal parking lot.

(c) On any private property where a sign installed by the owner or person in lawful possession thereof prohibits such activity.

10.42.030 Regulation on other sidewalks. A person operating or riding on a skateboard, roller skates, roller skis or play vehicle on the sidewalk outside the business or commercial districts of the City zoning ordinance shall yield the right-of-way to pedestrians using City sidewalks.

10.42.040 Violation – Penalty. Any person who violates Section 10.42.010 (A), 10.42.020 or 10.42.030 shall, upon conviction, be required to forfeit not less than \$25 nor more than \$100, together with the costs of prosecution, and in default of payment of such forfeiture shall be incarcerated in the County Jail until such forfeiture and costs are paid, not exceeding 30 days. Any person who violates Section 10.42.010 (B) shall, upon conviction, be required to forfeit not less than \$1.00 nor more than \$25.00, together with the costs of prosecution, and in default of payment of such forfeiture shall be incarcerated in the County Jail until such forfeiture and costs are paid, not exceeding 30 days; provided, that an unlicensed bicycle may be impounded until a license has been paid for and issued. (Ord. 422, 1990)

Chapter 10.44

COMPRESSION BRAKES

Sections:

10.44.010 Compression brakes
10.44.020 Violation – Penalty

10.44.010 Compression brakes. No person shall employ the type of motor vehicle brake (commonly known as a "jake brake" or engine retarder), which is activated by compression of the engine or any unit or part thereof, except to avoid damage to property or injury to person.

10.44.020 Penalty. A person who violates this ordinance shall be required to forfeit not less than \$10.00 nor more than \$50.00, together with the costs of prosecution, and in default of payment shall be imprisoned in the County jail until such forfeiture and costs are paid, not exceeding 30 days (ORD 547, 2003)

Chapter 10.46

Neighborhood Electric Vehicles

Sections:

10.46.010	Definition
10.46.020	Permitted Use of Neighborhood Electric Vehicles on City Streets
10.46.030	Permitted Users of Neighborhood Electric Vehicles
10.46.040	License and Title
10.46.050	Operation of Neighborhood Electric Vehicles
10.46.060	Charging Devices
10.46.070	Enforcement

10.46.010 Definition. "Neighborhood electric vehicle" means a motor vehicle that is propelled by electric power and that conforms to the definition and requirements for low-speed vehicles as adopted in the federal motor vehicle safety standards for low-speed vehicles under 49 CFR 571.3(b) and 571.500. "Neighborhood electric vehicle" does not include a golf cart.

10.46.020 Permitted Use of Neighborhood Electric Vehicles on City Streets. A neighborhood electric vehicle may be operated on any street, connecting highway or state trunk highway intersection within the City that has a posted speed limit of 35 miles per hour or less. Neighborhood Electric Vehicles may only cross intersections where both of the intersecting streets or highways have a posted speed limit of 35 miles per hour or less.

10.46.030 Permitted Users of Neighborhood Electric Vehicles. Any person who operates a neighborhood electric vehicle on any street, connecting highway or state trunk highway intersection as set forth in Section 10.46.020 above must have a valid driver's license.

10.46.040 License and Title. Neighborhood electric vehicles shall be licensed by the City and the license shall be issued to the owner of the vehicle. The annual fee for a license shall be set by the City Council from time to time. Licenses shall be issued by the City Clerk and shall be valid from April 1 to March 31. No partial licenses shall be issued and no refunds shall be made for neighborhood electric vehicles sold before the license year ends. Neighborhood electric vehicle licenses are not transferrable between owners. The license shall be clearly displayed on the rear of the neighborhood electric vehicle. Owners of neighborhood electric vehicles shall also obtain a certificate of title from the Wisconsin Department of Transportation.

10.46.050 Operation of Neighborhood Electric Vehicles. Neighborhood electric vehicle shall comply with all state and local traffic laws, including but not limited to Section 10.04.020 of the Viroqua Municipal Code. Owners and operators shall of neighborhood electric vehicles shall be subject to citations and forfeitures for any such violation.

10.46.060 Charging Devices. Electrical cords, connections or other charging devices shall not cross public land including but not limited to a sidewalk, terrace, street, etc.

10.46.070 Enforcement. Each violation of a State or local traffic code not contained within this chapter shall subject the operator of the neighborhood electric vehicle to the citations and penalties set forth for such violations in the applicable State Statues and City Ordinances. If not otherwise provided, the penalty for violation of this chapter shall be \$30 per occurrence, plus additional costs and penalties.

Chapter 10.48

Races on City Streets

Sections:

10.48.010	Definitions
10.48.020	Permit Required
10.48.030	Application for Permit
10.48.040	Permit Issuance or Denial
10.48.050	Time for Action on Application
10.48.060	Notice of Permit to Officials
10.48.070	Duties of Permittee and Race Coordinator
10.48.080	Revocation of Permit
10.48.090	Fees
10.48.100	Indemnification

10.48.010 Definitions. As used in this Chapter:

- A. "Chief of Police" is the chief of the City of Viroqua Police Department, or his or her designee.
- B. "Person" is any person, firm, partnership, association, corporation, company or organization of any kind.
- C. "Race" is any organized competition of speed and endurance. It shall include, but not be limited to, bicycle races, foot races, race walking, wheelchair racing, rollerblading, marathons and jogging or running events.

10.48.020 Permit Required. No person shall engage in, participate in, aid, form or start any race unless a race permit therefor has been obtained from the Chief of Police.

10.48.030 Application for Permit. A person seeking issuance of a race permit shall file an application with the Chief of Police on forms provided at the Police Department or City Hall.

- A. Time for application. Race permit applications should be filed as soon as possible in advance of the race. In any case, race permit applications must be filed not less than thirty (30) calendar days before the date on which the race is proposed to take place. Failure to timely file may be grounds for denial of the permit.

B. Content of application. The application for a race permit shall set forth the following information:

1. If the race is proposed to be conducted for, on behalf of, or by an organization, the name, address and telephone number of the headquarters of the organization, and of the authorized and responsible heads of such organization.
2. The name, address and telephone numbers of the person who will be the race coordinator and who will be responsible for its conduct.
3. The date when the race is to be conducted.
4. The details of the proposed route requested, including the starting point and termination point, and a legible route map.
5. The approximate number of persons who will constitute such race.
6. The hours when the race will assemble, start and terminate. No permit shall be issued unless the race is held on a Saturday, Sunday or a legal holiday starting no earlier than one hour after sunrise and finishing no later than one hour prior to sunset.
7. A statement as to whether the race will occupy all or only a portion of the width of the streets proposed to be traversed.
8. The desired location by streets of any assembly areas for the race.
9. The time at which participants will begin to assemble at any such assembly area or areas.
10. If applicable, the interval of space between units of the race.
11. If the race is designed to be held by, and on behalf of or for any person other than the applicant, the applicant shall file with the Chief of Police a communication in writing from the person proposing to hold the race authorizing the applicant to apply for the permit on behalf of the person proposing to hold the race.
12. A detailed traffic control plan, including who will provide traffic control and police supervision.
13. Any other information as the Chief of Police shall find necessary to the enforcement of this chapter.

:

10.48.040. Permit Issuance or Denial. The Chief of Police shall issue a permit as provided herein. However, the Chief of Police shall deny the application for such permit if, after review of the application and other pertinent information as may be obtained, the Chief of Police finds any of the following

A. The conduct of the race will substantially interrupt the safe and orderly movement of other traffic contiguous to its route or will interfere with street maintenance or other legally permitted events.

B. The concentration of persons at the assembly points of the race will unduly interfere with the proper fire and police protection of, or ambulance service to, areas contiguous to the assembly areas.

C. The conduct of the race will interfere with the movement of firefighting equipment or emergency vehicles en route to a fire or emergency.

D. The applicant will not agree to pay the fees listed in section 10.48.090.

E. To ensure that no such conditions exist and to avoid denial of the application, the Chief of Police or the applicant may recommend amendments to the application before the time for action in section 10.48.050 has expired. If such amendments are accepted in writing by the applicant, the application shall be amended in conformance therewith and without affecting the timeliness of the application.

10.48.050 Time for Action on Application. The Chief of Police shall grant or deny an application for race permit applications within five (5) business days after the receipt of the application.

10.48.060 Notice of Permit to Officials. Immediately upon the issuance of a race permit, the Chief of Police shall send a copy thereof to the City Clerk.

10.48.070 Duties of Permittee.

A. Within two (2) hours immediately following the end of the race, the permittee will clean up, remove and dispose of all litter or material of any kind which is placed or left on the street because of the race. Should the permittee fail to do so the City of Viroqua will bill the permittee for all costs related to the cleanup, removal and disposal of litter left on the street because of the race. If the permittee fails to satisfy this obligation within the time specified in the invoice, the City of Viroqua may commence appropriate legal action to collect all debts owed to the City. In addition, no future applications by the permittee will be considered until all obligations are satisfied.

B. Permittee will provide, at its own expense, either traffic control agents or police personnel at all intersections requiring traffic control as determined by the Chief of Police. The Chief of Police, at his or her discretion, may require the permittee to post a deposit to cover the cost of providing traffic control agents or police personnel for the event.

C. The permittee will provide volunteers to monitor the barricades at intersections not requiring traffic control personnel.

D. The permittee will provide, install and remove the barricades, signs and delineation equipment as directed by the Chief of Police or his or her designee.

10.48.080 Revocation of Permit. Permits issued hereunder may be subject to immediate revocation by the Police Department if the Department determines that there is a violation of this Chapter or of the permit whenever any race departs from or is conducted in a manner substantially different from that indicated in the application or lacks adequate traffic control to protect public safety. In such event the permit shall be deemed to be automatically revoked and the race shall be automatically terminated. This provision may be invoked when the permittee either violates the terms of the permit or refuses to conform to the terms of the permit after advised to do so by the police.

10.48.090 Fees. No application fee shall be charged if the application is received by the Chief of Police more than thirty (30) days prior to the event. Applicants seeking a race permit less than thirty (30) days from the event shall pay a fee of \$100. The application fee is non-refundable.

10.48.100 Indemnification. Permittee agrees to defend, indemnify and hold the City of Viroqua, its officers and employees harmless from any liability, claim, damages, costs, judgments or expenses, including attorney's fees, resulting directly or indirectly from an act or omission of the permittee, its agents or employees, arising out of the activity authorized by such permit and against all loss caused in any way by reason of the failure of the permittee to fully perform all obligations under this agreement.

Chapter 10.50ALL-TERRAIN VEHICLES AND UTILITY TERRAIN VEHICLES

Sections:

10.50.010	Purpose
10.50.020	Adoption of Statutory and Administrative Code Provisions
10.50.030	ATV/UTV Routes
10.50.040	Closure of Routes
10.50.050	Signs
10.50.060	Rules of Operation
10.50.070	Licensing, Registration and Insurance
10.50.080	Penalty

10.50.010 PURPOSE. The purpose of this Chapter is to establish All-Terrain Vehicle ("ATV")/Utility Terrain Vehicle ("UTV") routes in the City of Viroqua and to regulate operation of said vehicles to ensure safe and enjoyable ATV/UTV recreation consistent with public rights and interests.

10.50.020 ADOPTION OF STATUTORY AND ADMINISTRATIVE CODE PROVISIONS. The provisions of Wis. Stat. §§23, 340 to 348 and Wisconsin Administrative Code NR64, and any subsequent amendments thereto, are hereby incorporated by reference as part of this Chapter, except those provisions thereof that conflict with this Chapter.

10.50.030 ATV/UTV ROUTES.

A. Designated ATV/UTV routes include all public streets and alleys within the City of Viroqua except Main Street (US HWY 14). Under Wis. Stat. §23.33(11)(am)(4) ATVs and UTVs are authorized to operate on State Highway 56 (Decker Street/W. Broadway Street) where the posted speed limit is 35 MPH or less.

B. No person may operate an ATV/UTV in City parks, cemeteries or any property owned or leased by the City, other than the designated ATV/UTV routes, without written permission from the City of Viroqua.

C. No person may operate an ATV/UTV on private property within the City of Viroqua without permission of the property owner.

10.50.040 CLOSURE OF ROUTES.

A. Temporary Closures. The Mayor or Viroqua Police Department may temporarily close an ATV/UTV route whenever conditions or circumstances require closure.

B. Permanent Closures. The Common Council may permanently close any route designated herein as an ATV/UTV route at any time, for any reason. Upon any such closure, the City will provide public notice and update route signage to reflect the closure.

10.50.050 SIGNS.

A. Routes must be signed in accordance with Wisconsin Administrative Code NR 64.12. The City of Viroqua has sole responsibility and authority to post ATV/UTV Route Signs. No person may install any sign on a designated ATV/UTV route without written authorization from the City of Viroqua.

B. No person may erect, remove, obscure or deface any authorized ATV/UTV route sign without written authorization from the City of Viroqua.

10.50.060 RULES OF OPERATION. The following rules of operation shall apply to all routes:

A. Speed. The maximum speed limit for ATV/UTV routes shall be the posted speed limit of the road. For alleys where no speed limit is posted, the maximum speed limit shall be 15 (fifteen) MPH.

B. ATV/UTV operators will observe all applicable rules of the road governing motorized vehicles while operating on designated routes in accordance with Wis. Stat. §23.33 and Wis. Stat. Ch. 346.

C. ATV/UTV operation is only authorized to the extreme right side of the paved roadway and with the flow of traffic, except that left turns may be made from any part of the roadway which is safe giving the prevailing conditions. Operation on sidewalks, boulevards, lanes intended for bicycles or pedestrians, unpaved shoulders, grassy in- slopes, ditches or other road right of way areas is prohibited.

D. All ATV/UTVs shall be operated in single file.

E. Equipment. No ATV or UTV may be operated on any designated routes within the City of Viroqua unless it conforms to all equipment requirements as set forth in Wis. Stat. §23.33. All ATVs and UTVs must display a lighted headlamp and tail lamp at all times during operation on designated routes within the City of Viroqua. All ATVs and UTVs must have functioning brake lights.

F. Exhaust system and muffler modifications prohibited. No person may operate any ATV/UTV on any route within the City of Viroqua unless the ATV or UTV is equipped with a functioning muffler to prevent excessive or unusual noise and with a functioning spark arrester of a type approved by the United States Forest Service. Muffler systems shall not emit any noise greater than 96 decibels on the A scale.

G. Radios or electronic sound amplification devices. No person may operate or park any ATV/UTV within the City of Viroqua while using a radio or other electronic sound amplification device emitting noise greater than 96 decibels on the A scale.

H. Seatbelts. All UTV operators and passengers must wear manufacturer installed seatbelts at all times.

I. Head Protection. All ATV/UTV operators and passengers who are under 18 years of age must wear head protection that meets or exceeds United States Department of Transportation minimum standards.

J. Parking Violations. ATVs and UTVs may only be parked in the same manner and in the same places designated for the parking of motor vehicles. The parking rules and regulations set forth in Viroqua Municipal Code Chapter 10.28 shall apply to ATV/UTV parking.

K. Open Intoxicants. No person may drink alcohol beverages while in or on an ATV or UTV on any route within the City of Viroqua. No person may possess any bottle, can, or receptacle containing alcohol beverages in or on an ATV or UTV on any route within the City of Viroqua unless said bottle, can or receptacle is unopened and sealed. The use or possession of open intoxicants by operators and passengers of ATVs and UTVs is strictly prohibited while utilizing ATV/UTV routes within the City of Viroqua.

L. Intoxicated Operation of ATVs and UTVs. Pursuant to Wis. Stat.

§23.33(4c):

1. No person may operate an ATV or UTV while under the influence of an intoxicant to a degree which renders the person incapable of safe operation of an ATV or UTV.
2. No person may engage in the operation of an ATV or UTV while the person has a blood alcohol concentration of 0.08 or more.
3. If a person has not attained the age of 21, the person may not engage in the operation of an ATV or UTV while the person has an alcohol concentration over 0.0.
4. No person may engage in the operation of an ATV or UTV while the person has a detectable amount of restricted controlled substance in his or her blood.

10.50.070 LICENSING, REGISTRATION AND INSURANCE.

- A. ATV/UTV operators must have a valid state-issued motor vehicle operator's license.
- B. ATV/UTV operators born after January 1, 1988 shall have a valid safety certificate issued by the Wisconsin Department of Natural Resources, another state or a province of Canada.
- C. ATV/UTV operators shall carry their motor vehicle license, safety certificate and proof of insurance while operating an ATV/UTV and shall display proof to a law enforcement officer upon request.
- D. ATV/UTV operators holding a probationary license are limited to one passenger other than their immediate family members.
- E. All ATVs and UTVs shall be registered for public use in accordance with Wisconsin Department of Natural Resources regulations and proof of registration shall be displayed as required by Wis. Stat. §23.33(2)(dg) and Wisconsin Administrative Code NR 64.04.
- F. No person may operate an ATV/UTV, or allow another person to operate an ATV/UTV, on any ATV/UTV route within the City of Viroqua unless the owner of the ATV/UTV carries liability insurance covering the vehicle being operated. The operator shall have display proof of insurance to a law enforcement officer upon request.

10.50.080 PENALTY.

A. The penalties set for in Wis. Stat. §23.33(13), and subsequent amendments thereto, are hereby adopted by reference as if fully set forth herein and shall establish the penalties for the violations referred to therein.

B. Any forfeiture for a parking violation will be as set forth in Viroqua Municipal Code Chapter 10.28.

C. If the violation has no corresponding penalty under Wis. Stat. §23.33(13), the penalty for a first offense violation of any provision of this Chapter shall be a forfeiture of at least \$50 (fifty dollars) and not more than \$250 (two hundred and fifty dollars), together with costs of prosecution. The penalty for any subsequent violation within the same calendar year shall be a forfeiture of at least \$100 (one hundred dollars) and not more than \$500 (five hundred dollars), together with costs of prosecution.

D. In addition to any forfeiture, a court may order restitution to repair any damage caused by a violation of this Chapter.

Chapter 10.52GOLF CARTS

Sections:

10.52.010	Purpose
10.52.020	Definitions
10.52.030	Operation of golf carts allowed; exceptions.
10.52.040	License required
10.52.050	Registration
10.52.060	Proof of liability insurance
10.52.070	Inspection
10.52.080	Denial and revocation
10.52.090	Operational regulations.
10.52.100	Disclaimer and liability
10.52.110	Enforcement

10.52.010 Purpose. The purpose of this section is to establish regulations to ensure the safety and welfare of persons and property relative to the operation of golf carts on public streets within the City.

10.52.020 Definitions. As used in this section, "golf cart" is defined as a vehicle designed and manufactured for operation on a golf course for sporting or recreational purposes and that is not capable of exceeding 20 miles per hour on a paved, level surface.

10.52.030 Operation of golf carts allowed: exceptions.

(a) Allowed. The operation of golf carts on the public streets within the City, except Main Street (US HWY 14), where the speed limit is 25 miles per hour or less in compliance with the provisions of this section shall be permitted. Golf carts may only operate across a state trunk or connecting highway if the state trunk or connecting highway has a speed limit of 35 miles per hour or less, the highway crossing will connect highways designated for golf cart operation and the highway crossing is marked with a highway crossing sign. It shall be unlawful to operate any golf cart that is not properly registered with the City or operate any golf cart at any place, time or in any manner not authorized herein or in violation of the provisions of this section.

(b) Exceptions. The operation of golf carts is not subject to the provisions of this section under the following circumstances:

(1) The operation of golf carts at golf courses or on private property with the consent of the owner.

(2) The use of a golf cart in connection with a parade, a festival or other special event, provided the consent of the event sponsor is obtained and provided the golf cart is used only during such event.

10.52.040 License required. No person who is less than 16 years of age or who does not have a valid driver's license issued by the State of Wisconsin or some other state may operate a golf cart on any public street within the City. For purposes of this section, a learner's permit shall not be considered as a valid driver's license, nor shall any license that has been revoked or suspended for any reason be considered as a valid driver's license during the period of suspension or revocation.

10.52.050 Registration. Golf carts shall be licensed by the City and the license shall be issued to the owner of the vehicle. The annual fee for a license shall be set by the City Council from time to time. Licenses shall be issued by the Chief of Police and shall be valid from April 1 to March 31. No partial licenses shall be issued and no refunds shall be made for golf carts sold before the license year ends. Golf cart licenses are not transferrable between owners. The license shall be clearly displayed on the rear of the golf cart. Owners of golf cart shall also obtain a certificate of title from the Wisconsin Department of Transportation.

10.52.060 Proof of liability insurance. The owner of the golf cart must provide a certificate of insurance listing the company, policy term, and minimum limits of liability of \$100,000 per person, \$300,000 per accident and \$5,000 for medical.

10.52.070 Inspection. Prior to issuing the initial registration permit or any renewal thereof, the golf cart shall either be inspected by the Chief of Police to determine that:

(a) The golf cart is equipped with headlights, taillights, turn signals, a rear vision mirror and at least two red rear reflectors at least three inches in height and width;

(b) The golf cart is equipped with a reflective "slow moving" sign or flag on the rear of the cart;

(c) The brakes provided by the manufacturer of the golf cart are in proper working order;

(d) The golf cart has all of the standard safety features provided by the manufacturer and has not been modified to exceed a speed of 20 miles per hour, nor otherwise modified in any way that creates a hazard; and

(e) The golf cart is equipped with all mechanical systems and safety equipment required by this section.

10.52.080 Denial and revocation. The initial registration of a golf cart may be denied or subsequently revoked by the Chief of Police if it is determined that:

(a) The application contains any material misrepresentation;

(b) The golf cart is not in compliance with the requirements of this section;

- (c) The golf cart has been altered or customized and no longer meets the definition of a "golf cart";
- (d) Equipment supplied by the manufacturer, especially safety equipment, has been removed from the golf cart or the vehicle identification or serial number has been removed; or
- (e) Other good cause shown, including repeated violations of this section.

10.52.090 Operational regulations. Golf carts shall not be operated on the public streets of the City, except in full compliance with the following:

(a) Dates and hours of operation. Golf carts may be driven on approved public streets from March 1 to October 31 between sunrise until sunset. Golf carts may not be operated when fog, smog, smoke, snow or other conditions reduce visibility so that the golf cart is not visible for a distance of 250 feet.

(b) Motor vehicle laws. All laws regarding the use of motor vehicles in the State of Wisconsin and all ordinances regarding the use of motor vehicles in the City not inconsistent therewith shall be observed, except that no golf cart may be operated at a speed in excess of 20 miles per hour.

(c) Right-of-way. The operator of a golf cart shall yield the right-of-way to motor vehicles and pedestrians. Golf carts shall operate in a single file on the far right side of the roadway with the flow of traffic.

(d) Public property and sidewalks. Golf carts shall not be operated on any sidewalk, pedestrian walkway, public park, bike path, or public trail, except by City personnel while on City business. Notwithstanding anything herein to the contrary, golf carts shall not be operated on property owned or leased by the City, except with the express written consent of the City Council and upon the terms and conditions as may be set forth in such written consent, or to gain access to a parking lot for purposes of parking.

(e) Golf cart capacity. The number of occupants in a golf cart shall be limited to the number of persons for whom individual seating is installed, and all riders must remain seated at all times while the golf cart is in operation.

(f) Commercial purposes. Golf carts may not be used for the commercial carrying of passengers or the hauling of freight.

(g) Parking. Golf carts may only be parked in the same manner and at the same places designated for the parking of motor vehicles. The stopping, standing, or parking of golf carts in an area where parking is not allowed or in any place that impedes the flow of traffic, pedestrian walkways or a passageway is prohibited.

(h) Towing. Golf carts may not be used for the purpose of towing another cart, trailer, or vehicle of any kind or for towing a person on roller skates, a skateboard, or a bicycle.

10.52.100 Disclaimer and liability .

(a) Disclaimer. Golf carts are not designed for nor manufactured to be used on public streets, and the City neither advocates nor endorses the golf cart as a safe means of travel on public streets, roads, and highways. The City in no way shall be liable for accidents, injuries or death involving the operation of a golf cart.

(b) Assumption of risk. Any person who owns, operates, or rides upon a golf cart on a public street, road or highway within the City does so at his or her own risk and peril and assumes all liability resulting from the operation of the golf cart.

10.52.110 Enforcement. Each violation of a State or local traffic code not contained within this chapter shall subject the operator of the golf cart to the citations and penalties set forth for such violations in the applicable State Statutes and City Ordinances. If not otherwise provided, the penalty for violation of this chapter shall be \$30 per occurrence, plus additional costs, and penalties.

Title 11

(RESERVED)

Title 12STREETS AND SIDEWALKSChapters:

- 12.04 Sidewalk Construction
- 12.08 Excavations
- 12.12 Obstructing Streets, Sidewalks and other Public Ways
- 12.16 Snow Removal
- 12.20 Removing Trees in Right of Way
- 12.24 House Numbering
- 12.26 Grade of Streets
- 12.28 Public work without bidding

Chapter 12.04SIDEWALK CONSTRUCTIONSections:

- 12.04.010 Standard cement sidewalk required.
- 12.04.020 Grading - Construction materials and methods.
- 12.04.030 Rough grading - City's responsibility.
- 12.04.040 Existing sidewalks - Repair or replacement width.
- 12.04.050 New sidewalks - Width.
- 12.04.060 Sidewalk repair or replacement; expense.

12.04.010 Standard cement sidewalk required. There shall be one standard sidewalk in the City, known as "a standard cement sidewalk", to be constructed as provided in Section 12.04.020. (Ord. 117 §1, 1946).

12.04.020 Grading - Construction materials and methods. All standard cement sidewalks shall be constructed as follows:

A. The ground shall be graded even and smooth on such grade as the Council determines and establishes.

B. The sidewalk shall be constructed of four inches of concrete made as follows:

1. One part Portland cement, two and one-half parts washed sand, and not less than three nor more than three and one-half parts washed crushed limestone or washed gravel not exceeding one inch in diameter shall be used, all to be machine mixed for not less than one and one-half minutes with water sufficient to make workable concrete having not more than a six-inch slump;

2. All forming and preparing of fine grade before placing concrete shall be in a good workmanlike manner;

November 2011 revision

3. The concrete shall be thoroughly spaded and worked into place and shall be trowelled and light-brush finished with suitable grooves to control cracking of the slab with not more than a one-half inch expansion joint for each sixty linear feet of sidewalk. (Ord. 117 §2, 1946).

12.04.030 Rough grading - City's Responsibility. All necessary rough grading, including dirt removal and fill, shall be done by the City, at its expense, to the grade as set forth in subsection A of Section 12.04.020. (Ord. 117 §3, 1946).

12.04.040 Existing sidewalks - Repair or replacement width. From and after June 25, 1946, all existing sidewalks repaired or replaced shall be repaired or replaced to the same width as the existing sidewalk, unless otherwise ordered by the Council. (Ord 117 §4, 1946).

12.04.050 New sidewalks - width. All new construction of sidewalks shall be of such width as the council from time to time determines and orders. (Ord 117 §5, 1946).

12.04.060 Sidewalk repair or replacement; expense. The director of public works may order repair or replacement of unsafe, defective or insufficient sidewalks, and either serve such order upon the owner(s) of the property affected personally or by certified mail, or by publishing such order in the official newspaper as a class 1 notice together with mailing such order by 1st class mail to the owner(s), and to keep an accurate record of the expense of laying, removing, and repairing such sidewalks in front of each lot or parcel of land, and to report such expense to the City Clerk, who shall enter the amount in the tax roll as a special tax against said lot or parcel, pursuant to Section 66.615, Wisconsin Statutes. The expense so incurred may be paid in 10 annual installments with deferred payments to bear interest at the rate set by the Council by resolution on the basis of the then-current interest rate.

Chapter 12.08

EXCAVATIONS

Sections:

12.08.010	Public way defined.
12.08.020	Permit – Required.
12.08.030	Permit – Fee.
12.08.040	Permit – Conditions of bonding.
12.08.050	Permit – Liability insurance required.
12.08.060	Regulations generally.
12.08.070	Notification procedure – Minimum interval between excavations.
12.08.080	Permissible emergency measures.
12.08.090	Utilities–Underground wiring–Placement permissible with lawful authority.
12.08.100	Utilities – Underground wiring – Filing of plan or map – Permit.
12.08.110	Utilities – Underground wiring – Emergency repair.
12.08.120	Nonapplicability to city work.
12.08.130	Violation – Penalty.

12.08.010 Public way defined. As used in this chapter, “public way” means public streets, highways and alleys, including boulevards, sidewalks and municipally -owned easements. (Ord. 215 §1, 1966).

12.08.020 Permit required. No person shall make or cause to be made any excavation or opening in any public way within the city without first obtaining a permit therefor from the superintendent of streets. (Ord. 215 §2, 1966).

12.08.030 Permit – Fee. The fee for a street opening permit shall be two dollars and shall be paid to the city treasurer -assessor who shall issue his receipt therefor. (Ord. 215 §3, 1966).

12.08.040 Permit – Conditions of bonding. A. Before a permit for excavating or opening any street or other public way may be issued, the applicant must execute and deposit with the city clerk an indemnity bond approved by the insurance and claims committee of the Council in the sum of three thousand dollars, conditioned that the applicant will fill up and place in good repair and safe condition all excavations and openings made in the street and will replace and restore the pavement over any openings he may make as near as can be to the state and condition in which he found it. Such bond shall also guarantee that if the city elects to make the street repair, the person opening the street will pay all costs of making such repair. Such bond shall be further conditioned that the applicant will observe the provisions of all state laws, ordinances, rules and regulations governing the issuance of permits under this section.

B. Such bonds may be filed individually for each excavation or an annual bond may be given covering all excavation done by the principal for one year beginning January 1. (Ord. 215 §4, 1966).

12.08.050 Permit – Liability insurance required. Prior to commencement of excavation work, a permittee must furnish the superintendent of streets satisfactory written evidence that he has in force and will maintain during the life of the permit and the period of excavation, public liability insurance of not less than one hundred thousand dollars for one person, three hundred thousand dollars for one accident, and property damage insurance of not less than fifty thousand dollars. (Ord. 215 §5, 1966).

12.08.060 Regulations generally. A. No opening in the streets or other public ways for any purpose shall be permitted when the ground is frozen, except where necessary as determined by the superintendent of streets.

B. In opening any street or other public way, all paving or ballasting materials shall be removed with the least possible loss of or injury to surfacing material and, together with the excavated material from trenches, shall be placed so as to cause the least practicable inconvenience to the public and permit free flow of water along gutters.

C. Every person shall enclose with sufficient barriers each opening which he may make in the streets or public ways of the city. All machinery and equipment shall be locked or otherwise effectively safeguarded from unauthorized use when not being used by the permittee, his agents or employees. Red lights shall be kept burning from sunset to sunrise, one red light to be placed at each end of the opening in the street or way and other lights sufficient in number and properly spaced to give adequate warning. Except by special permission from the superintendent of streets, no trench shall be excavated more than two hundred fifty feet in advance of pipe laying, nor left unfilled more than five hundred feet where pipe has been laid. All necessary precautions shall be taken to guard the public effectively from accidents or damage to person or property through the period of the work. Each person making such opening shall be held liable for all damages, including costs incurred by the city in defending any action brought against it for damages, as well as for the cost of any appeal that may result from the neglect by such person or his employees of any necessary precaution against injury or damage to persons, vehicles or property of any kind.

D. In opening any street, sidewalk or other public way, the paving materials, sand, gravel and earth, or other material moved or penetrated, and all surface monuments or hubs must be removed and replaced as nearly as possible in their original condition or position and in the same relation to the remainder as before. Any excavated material which in the opinion of the superintendent of streets is not suitable for refilling shall be replaced with approved backfill material. All rubbish shall be immediately removed, leaving the street or way in perfect repair. In refilling the opening, the earth must be puddled or laid in layers not more than six inches in depth and each layer rammed, tamped, or flushed to prevent after settling. When the side of the trench will not stand perpendicularly, sheathing and braces must be used to prevent caving. No timber, bracing, lagging, sheathing or other lumber shall be left in any trench. The city may elect to have the city make the pavement repair for any street or sidewalk opening, in which case the cost of making such repair shall be charged to the person making the street opening. (Ord. 215 §6, 1966).

12.08.070 Notification procedure – Minimum interval between excavations.

A. Whenever the Council determines to provide for the permanent improvement or repaving of any street, such determination shall be made not less than thirty days before the work of improvement or repaving shall begin. Immediately after such determination by the Council, the superintendent of streets shall notify in writing each person, utility, city department or other agency owning or controlling any sewer, water main, conduit or other utility in or under said street, or any real property abutting said street, that all such excavation work in such street must be completed within thirty days.

B. After such permanent improvement or repaving, no permit shall be issued to open, cut or excavate said street for a period of five years after the date of improvement or repaving unless, in the opinion of the superintendent of streets, an emergency exists which makes it absolutely essential that the permit be issued. (Ord. 215 §7, 1966).

12.08.080 Permissible emergency measures. In the event of an emergency, any person owning or controlling any sewer, water main, conduit or other utility in or under any street, and his agents or employees, may take immediate proper emergency measures to remedy dangerous conditions for the protection of property, life, health or safety without obtaining an excavation permit; provided, that such person shall apply for an excavation permit not later than the end of the next succeeding business day and shall not make any permanent repairs without first obtaining an excavation permit under the provisions of this chapter. (Ord. 215 §8, 1966).

12.08.090 Utilities – Underground wiring – Placement permissible with lawful authority. Any individual, firm or corporation having and possessing lawful authority to use the streets, alleys, public highway, boulevards, sidewalk space or public ground within the city for telegraph, telephone, TV cable or electric supply purposes is given permission to place the wires, cable or conduits therefor underground for said purposes in the streets, alleys, public highway, boulevards, sidewalk space or public grounds within the city, except within the boundaries of state and federal highways. (Ord. 233 §1, 1970).

12.08.100 Utilities – Underground wiring – Filing of plan or map – Permit. It is declared unlawful for any individual, firm or corporation, to do or cause to be done any work of construction, reconstruction, maintenance or repair of any underground conduit, manhole, subway or cable for telegraph, telephone, TV cable or electric supply purposes, within any street, alley, public highway, boulevard, sidewalk space or public grounds within the city requiring disturbance of the surface, whether natural or artificial, or the space beneath the surface, without first having filed with the city engineer a plan or map showing, as far as practicable, the location and depth of such underground conduit, manhole, subway or cable, which plan or map shall be maintained in current condition on file with the city engineer; and no such excavation or construction shall be commenced until the plan or map has been approved and a permit therefor obtained from the city engineer. (Ord. 233 §2, 1970).

12.08.110 Utilities – Underground wiring – Emergency repair. In the event of an emergency, any individual, firm or corporation controlling any such underground conduit, manhole, subway or cable for telegraph, telephone, TV cable or electric supply purposes, and his or its agents or employees may take immediate proper emergency measures to remedy dangerous conditions for the protection of property, life, health or safety, or to restore interrupted service, without obtaining a permit as required in Section 12.08.100; provided, that such individual, firm or corporation shall apply for such permit within forty-eight hours thereafter and shall, within such time, file with the city engineer plans or maps showing any changes in the location and/or depth of any underground conduit, manhole, subway or cable occasioned by such emergency repairs. (Ord. 233 §3, 1970).

12.08.120 Nonapplicability to city work. The provisions of this chapter shall not apply to excavation work under the direction of the superintendent of streets by city employees or contractors performing work under contract with the city, necessitating openings or excavations in the city streets or other public ways, which opening or excavations shall be regulated by the contract between the city and the contractor. (Ord. 215 §9, 1966).

12.08.130 Violation – Penalty. Any person making or causing to be made any excavation or opening in any street, alley, highway, sidewalk, municipally-owned easement or other public way within the city contrary to the provisions of this chapter shall forfeit a penalty of not less than twenty-five dollars nor more than two hundred dollars and, in default of payment thereof, shall be imprisoned in the county jail until such forfeiture is paid, but not in excess of thirty days. (Ord. 215 §10, 1966).

Chapter 12.12OBSTRUCTION STREETS, SIDEWALKS AND OTHER PUBLIC WAYS

Sections:

12.12.10	Obstruction Streets, Sidewalks and other Public Ways
12.12.20	Boulevard Flower Gardens
12.12.30	Clearing Sidewalks; Maintaining Boulevards
12.12.40	Penalties

12.12.10 Obstructing Streets, Sidewalks and other Public Ways. No person shall place any thing in or on any public way except as otherwise permitted by this Code for motor vehicles, for garbage and refuse collection and disposal, for other temporary purposes which the City permits in writing, and except to extent allowed under Section 12.12.20. A "public way" includes, but is not limited to, a street, sidewalk, boulevard, alley, utility easements, drainage and other easements, and waterways. (Ord 15OR001; Ord. 140R003; Ord. 130R003; Ord. 080R005)

12.12.20 Boulevard Flower Gardens.

A. Purpose. The purpose of this Section is to establish criteria for private plantings within the boulevard section of the public right-of-way. This Section allows for permissive use of the boulevard without the need to apply for a privilege in the street. Uses inconsistent with this Section may be subject to penalty under Section 12.20.40 or may require additional approval as required by the Viroqua Municipal Code or Wisconsin State Statutes. Uses consistent with this Section are an exception to the privilege in the street requirements under Wis. Stat. §66.0425 as they are being permitted by general ordinance affecting the whole public as allowed for under Wis. Stat. §66.0425(1).

B. Definitions.

1. "Boulevard" as used in this Section means all land lying between the lot line and the curb line, or where no curb the pavement edge of streets or highways. A property owner may plant and maintain a garden on the boulevard abutting his or her residential property.

2. "Permissible plantings" are herbaceous (non-woody) plants, other than fruits or vegetables.

3. "Owner" is the person who has legal title to a property immediately adjacent to a boulevard.

4. "Occupant" is any person who legally resides in a residential property immediately adjacent to a boulevard.

C. Permissible plantings. The owner may plant, maintain and cultivate, or allow an occupant of the property to plant, maintain and cultivate permissible plantings that are consistent with this Section. Permissible plantings do not include trees not approved by the City, shrubs, fruits or vegetables.

1. Plantings may not exceed 36 inches in height.
2. Plantings must be maintained to prevent overhang or encroachment onto the sidewalk, curb or street area.
3. A minimum of a two-foot walkway of grass or low growing ground covers shall be maintained from the street to the sidewalk at the midpoint of the boulevard.
4. The planting bed shall be kept level with any sidewalk and any curb.
5. A minimum of a one-foot strip of grass or low growing groundcover shall be maintained next to the sidewalk and curb or street surface to prevent soil runoff on the sidewalk or street.
6. Boulevard flower gardens are not allowed adjacent to any state highway, nor within the "Sight Triangle" (defined as the triangle formed by measuring 15 feet back in both directions from the intersection of two sidewalks; if there are no sidewalks, 15 feet back from where the walks normally would be). Plants, trees or shrubbery planted or maintained adjacent to a state highway or in the sight triangle shall be removed.

D. Responsibility. The owner or occupant responsible for the permissible plantings accepts full responsibility for the care and maintenance of the permissible plantings and understands that permissible plantings in the boulevard are made at their own risk, and that they may be removed at any time by the City without compensation. The owner or occupant seeking to place permissible plantings in the

boulevard is responsible for contacting Digger's Hotline to identify and mark any underground utilities prior to digging within the right-of way.

E. Removal. Prior to performing any public works project that may threaten any permissible planting, the City shall attempt to notify the owners and occupants of the City's plans in order to give the owner or occupant sufficient time to relocate plantings. This notification provision shall not apply in emergency situations or where such notice is not practicable. In the event the City or other public entity or public utility interferes with the boulevard plantings, it shall only restore the boulevard by the use of black dirt and grass seed or sod. In no event shall the City be liable for any damage to, disruption of, or removal of plantings or ground cover material, either direct or indirect, as a result of the City, its employees, agents, or contractors, performing any installation, maintenance, or repairs.

F. Notice of Violation Regarding Boulevard Gardens. The City encourages neighbors to communicate with one another about safe and proper sightlines and express concerns if visibility or other safety concerns become an issue. The City will provide the homeowner or occupant written notice of the specific violation observed and such written notice will also state that the violation must be corrected within 15 days. The notice will be served upon the homeowner and/or occupant by first class mail or personal service.

12.12.030 Clearing Sidewalks; Maintaining Boulevards. Every owner of property abutting a sidewalk shall keep such abutting sidewalk clear of all things. The owner of a lot or land in the City abutting a boulevard is required to maintain, or have maintained by his or her tenant, the boulevard abutting the owner's lot or land. No person shall change the condition of any boulevard area within the City except for a boulevard flower garden. Prohibited changes include, but are not limited to, installation of fencing, paving over boulevard areas with asphalt, recycled asphalt, brick pavers, concrete, landscaping gravel, exposed aggregate, rocks, plant cages, trellis or stakes. Anything placed within the boulevard is done so at the risk of the abutting property owner; the City may remove any such unlawful things; and the City shall not be responsible for restoring damage to such unlawful things caused by street maintenance, drainage and utility construction, and snowplowing.

12.12.040 Penalties. A person who continues to violate this ordinance after being provided written notice, shall be required to forfeit not less than \$50.00 nor more than \$100.00 for a first offense, and not less than \$100.00 nor more than \$200.00 for each subsequent offense, together with the costs of prosecution and upon failure to pay such forfeiture and costs shall be imprisoned in the County Jail not exceeding 30 days. Every two weeks that a property remains in violation constitutes a separate offense. In the event the City clears the street, sidewalk, or public way, the cost thereof may be assessed against the abutting owner who was given notice. (Ord 15OR001; Ord 14OR003; Ord 13OR003; Ord 08OR005; Ord 21OR003)

Chapter 12.16SNOW REMOVALSections:

- 12.16.010 Removal of Snow Required.
- 12.16.020 Noncompliance – City action.
- 12.16.030 Deposit on streets – Prohibited.
- 12.16.080 Violation – Penalty.

12.16.010 Removal of Snow Required

The owner of property abutting a street shall clean the sidewalk abutting such lot of snow or ice to the full width of such sidewalk within twenty-four hours after the cessation of snowfall, and shall cause the same to be kept free from snow or ice; provided, that when ice has so formed on any sidewalk that it cannot be removed, said owner shall keep the same sprinkled with commercially available ice-melt or non-slip agents including salt or sand.

12.16.020 Noncompliance – City action. In cases where any sidewalk remains covered in any part with snow or ice longer than twenty-four hours after the cessation of the most recent snowfall, it shall be the duty of the superintendent of public works to cause such snow or ice to be removed from the full width of such sidewalk and to report the date when, and address (or other description) where such work was done, and whether the sidewalk length exceeded 100 feet, to the City Clerk-Treasurer, who shall insert the following amount in the tax list thereafter to be made out as a special charge against the lot abutting such sidewalk, which shall be collected as other taxes upon real estate are collected:

Sidewalk not over 100 feet:

First time shoveled, \$100; second time shoveled during the same winter \$150.00; third and subsequent times shoveled during the same winter \$175.00.

Sidewalk over 100 feet:

First time shoveled, \$200; second time shoveled during the same winter \$250.00; third and subsequent times shoveled during the same winter \$275.00.

The Public Works Committee may by resolution establish different charges. (07OR007)

12.16.030 Deposit on streets – Prohibited. No person shall deposit snow in any public street, alley or roadway.

12.16.080 Violation – Penalty. In addition to the charges to be assessed against property, any person violating any provision of this chapter may be required to forfeit not more than fifty dollars together with the costs of prosecution; and in default of payment of such forfeiture and costs, shall be imprisoned in the county jail for not more than thirty days. Each day a violation exists may be charged and prosecuted as a separate offense.

Chapter 12.20

REMOVING TREES IN RIGHT OF WAY

Sections:

12.20.010 Prohibited acts – Penalty.

12.20.010 Prohibited acts – Penalty. Any person who willfully or maliciously cuts or breaks down, digs or pulls up by the roots any living forest, shade or ornamental tree standing, planted out or growing in any of the streets or public grounds of the city, except by the order or direction of the Council when the same is necessary for the purpose of improving, repairing or grading any streets or sidewalks; and any person who peels, girdles, cuts or otherwise injures or disfigures any such tree planted out, standing or growing as aforesaid; and any person who aids or causes the same to be done by hitching any horse or other animal thereto, or so near that the same may be done, or causes the same to be done in any other manner, shall be punished by a fine not exceeding twenty-five dollars and the costs of prosecution. (Ord. 10 §1, 1904).

Chapter 12.24

HOUSE NUMBERING

Sections:

12.24.01	0	Generally.
	12.24.020	Base or division lines designated.
	12.24.030	Locations designated generally.
	12.24.040	Blocks – Method of increases – Numbers per block.
12.24.05	0	Even and odd.
	12.24.060	Streets not extending to the base line.
	12.24.070	Attachment of numbers required.
	12.24.080	Attachment of numbers – Noncompliance – Penalty.

12.24.010 0 Generally. All houses and lots in the city shall be numbered in accordance with the plan set forth in this chapter. (Ord. 35 §1, 1917).

12.24.020 Base or division lines designated. The base or division lines for assigning numbers to houses and lots in the city shall be Main Street and Court Street. (Ord. 35 §2, 1917).

12.24.030 Locations designated generally. A. All houses and lots north of Court Street shall be known as located at number _____, North _____ Street.

B. All the houses and lots south of Court Street shall be known as located at number _____, South _____ Street.

C. All the houses and lots east of Main Street shall be known as located at number _____, East _____ Street.

D. All the houses and lots west of Main Street shall be known as located at number _____, West _____ Street. (Ord. 35 §3, 1917).

12.24.040 Blocks – Method of increases – Numbers per block. The number of blocks shall be increased from the respective base lines in even hundreds, that is to say, the first block shall be one hundred, the second block shall be two hundred, the third block shall be three hundred, etc.; and there shall be assigned one hundred numbers to each block, square or space that would be one block or square if streets each way were so extended as to intersect each other, and at least one number shall be assigned to each twenty-two feet of frontage. (Ord. 35 §4, 1917).

12.24.050 Even and Odd. All lots and houses on the north and west side of all streets shall be numbered with the even numbers, and all houses and lots on the south and east sides of all streets shall be numbered with the odd numbers. East lot of house shall commence with the hundred assigned to that block, and each shall increase from the baseline at least one number for each twenty-two feet of frontage. (Ord. 35 §5, 1917).

12.24.060 Streets not extending to the base line. All streets not extending to the base line shall take the same number of hundreds that said streets would take had they extended to the base line and, in case the number is not otherwise determined, it shall be determined by the street committee. (08OR014; Ord. 35 §6, 1917).

12.24.070 Attachment of numbers required. It shall be the duty of each owner and occupant of any building fronting up on any street, including all principal buildings (excluding accessory buildings such as detached garages, garden sheds, etc.) to securely attach

or apply to the front of such building, in a conspicuous position and not higher than the first or ground story of said building so that the same can be plainly seen from the street, the proper number for each building in accordance with the numbering provided for in this chapter. Such owner or occupant shall, at all times thereafter, keep such numbers so attached or applied. The numbers shall be black on white, or other color which, considering the building color, shall be plainly seen from the street, and each number shall be a minimum width of 3" and a minimum height of 4" (08OR014; Ord. 35 §7, 1917).

12.24.080 Noncompliance – Penalty. If the owner or occupant of any building required by this chapter to be numbered neglects to duly attach and maintain the proper number on such building, after written notice of the requirement, he or she shall be required to forfeit not less than \$ 25 nor more than \$100 together with the costs of prosecution and in default of payment of such forfeiture and costs shall be imprisoned in the County Jail not exceeding 30 days. (08OR014; Ord. 35 §8, 1917).

Chapter 12.26

GRADE OF DEDICATED STREET

Sections:

12.26.010 Grade of Dedicated Streets.

12.26.010 Grade of Dedicated Streets. It shall be a condition to the acceptance of any dedication for street purposes that the dedicator shall be required to complete all rough grading, completion of the sub-grade, and gravel base according to City policy as determined by the Public Work Committee. (Ord. 376, 1985; Ord. 457, 1995).

Chapter 12.28

PUBLIC WORK WITHOUT BIDDING

Sections:

- 12.28.010 Public work without bidding
- 12.28.020 Report of cost of public work

12.28.010 Public work without bidding. Pursuant to the provisions of section 62.15 (14), Wisconsin Statutes, the City may do the following class of public work without submitting the same for bids otherwise required by law:

- Street construction and improvement
- Airport runway
- Utilities including sanitary sewer, water, storm sewer

12.28.020 Report of cost of public work. The Public Works Committee, or employees directed by the Committee, shall keep an accurate account of the cost of the public work, including the necessary overhead expense. Upon the completion of the work described, the Committee shall make a complete report of the work to the council, stating in detail the items of cost and the total cost of doing the work. The city clerk shall publish the report as a part of the proceedings of the council. (Ord 11OR002)

Title 13WATER AND SEWERSChapters:

- 13.04 Water Service Within City
- 13.08 Water Service to Areas Prior to Annexation
- 13.10 Lead Service Line Replacement
- 13.12 Fire Hydrants
- 13.20 Sewer Use and User Charges
- 13.30 Cross Connection Control
- 13.32 Private Wells
- 13.34 Wellhead Protection

Chapter 13.04WATER SERVICE WITHIN CITY

13.04.010	General contractual obligations
13.04.020	Property owner responsibility
13.04.030	Violation - shutting off - turning on
13.04.040	Administration
13.04.050	Permit required - application
13.04.060	Rates
13.04.070	Meter reading
13.04.080	Fees - collection - distribution
13.04.090	Damages and repairs - liability
13.04.100	Access to private premises
13.04.110	Meter approval and installation
13.04.120	Plumbing - permit required
13.04.130	Turning water off/on - fee
13.04.140	Violation - penalty

13.04.010 General contractual obligations. All rules, regulations and water rates provided by the ordinance codified in this chapter or any ordinance thereafter adopted, shall be conclusively deemed the contract between the City and every person, company, corporation or user of city water; and every person, firm corporation or user of city water shall, by the use of such water, be deemed conclusively to have assented to all such rules, rates and regulations. (Ord. 43 §1, 1920).

13.04.020 Ultimate contractual obligation responsibility of property owner.
All contracts for the use of water shall be deemed made with the owners of the property served (not renters) and the lessors or owners shall be deemed to have agreed to pay and shall pay the water rates and water rentals for water supplied to such property owner's property, whether with or without their consent. No agreement between landlords and their tenants in respect to payment of the water rental or water tax shall have any validity as against the city. (Ord. 43 §2, 1920).

13.04.030 Violation – Shutting off and turning on – Minimum rental payment.

A. Whenever any property owner, landlord, or tenant of such landlord, or other user of city water violates any of the rules, regulation, or provisions of this chapter or any other rule of the Council, in addition to all other penalties and forfeitures provided for in this chapter or provided by law, the water shall be shut off from the property of the person violating the same and shall not be turned on again except by order of the council upon payment of the expense of shutting it off and turning it on and complying with such other terms as the Council imposes; and the Council shall have the right to declare any payment for water forfeited, and the same shall thereupon be forfeited.

B. All lessors, property owners and users of city water shall pay the minimum rental for each separate property, residence, family or household so supplied, whether supplied from one or more hydrants. (Ord. 43 §3, 1920).

13.04.040 Administration – Provision of printed materials by city clerk. The city clerk shall provide all blanks, books, bills, permits, receipts or other printed blanks necessary or convenient for the administration of this chapter. (Ord. 43 §4, 1920).

13.04.050 Permit required – Application – Allocation of costs – Minimum rates for building operations. A. No person shall cut, tap or cause to be tapped, or use water from any water main of the city without first having made a written application therefor to the city clerk, on a blank to be provided by him, and without having received from such city clerk a duplicate original permit authorizing the applicant to tap such water main and the city clerk shall keep one duplicate original permit on file in his office.

B. On granting such permit, the city shall, at its own expense, put in the water main and extend it from the nearest street main to the boundary line of the sidewalk of the applicant and put in a shutoff. The applicant shall, at his own expense, extend such pipeline from such point to the place on his own property desired so that no hydrants shall be permitted to remain within the limits of the public streets or alleys. Pipes shall be at least five and one-half feet under the ground and all pipes laid in streets or alleys shall be the property of the city. All hydrants on private property shall be at least one rod from the street line or alley line. Multiple rates will be charged applicants who locate hydrants on property lines for the purpose of supply water to a plurality of residences.

C. In case the applicant is a contractor or other person who desires to use water for building operations, or any other person who desires city water for any temporary purpose, the application shall state fully the purpose for which the water is to be used and the probable amount that will be consumed, and such applicant shall pay minimum meter rates. (Ord. 43 §5, 1920).

13.04.060 Rates – Adoption by reference of statute. The provisions of Section 66.069(1) of the Wisconsin Statutes, 1975, governing rates and the collection thereof, are adopted by reference. (Ord. 283 §1, 1977; Ord. 43 §6, 1920).

13.04.070 Meter reading – Payment failure – Shutoff. A. Water meters of the water utility of the city shall be read quarterly, and water bills for such period shall be paid by the user during the following calendar months.

B. Whenever any property owner, landlord or other tenant of such landlord, or other use of city water fails to pay in accordance with subsection A of this section, the water shall be shut off from the property of the person failing to pay the same in accordance with Section 13.04.030. (Ord. 84 §2, 1935; Ord. 43 §6A, 1920).

13.04.080 Fees – Collection – Distribution. The fees provided by Section 13.04.060, as well as the penalties, shall be collected by the treasurer-assessor and paid into the treasury to the credit of the particular funds entitled thereto, and shall be distributed as water rentals. (Ord. 43 §7, 1920).

13.04.090 Damages and repairs – City nonliability. Whenever any leak occurs and whenever any repair so requires, as well as whenever in the judgment of the Council, the city water shall be turned off for any reason and may be turned off without any liability for damage to any user and without the same being held to be a breach of any contract for service on the part of the city, all such damage being waived. No claim for damage or other loss, due to negligence of otherwise, shall be made against the city on the part of any user of the city water by reason of the breaking of any main pipe, service pipes or otherwise, all such claims and damage being waived. Also, the city may, at any time, repair any meter or install a new meter and charge the expense thereof to the property owner which shall be collected as water rentals. (Ord. 43 §8, 1920).

13.04.100 Access to private premises authorized. The chairman of the committee on water of the Council, any city official, and any person authorized by the Council, shall have access at any reasonable time to the premises of any water consumer for the purpose of inspecting the water works installation and to ascertain whether or not water is being wasted, as well as to read, repair or install meters. (Ord. 43 §10, 1920).

13.04.110 Meter installation and approval – Application required. The city will install and approve water meters for any person upon application being made to the clerk. All such applications for installation of meters, together with a statement of the cost of installation endorsed on the application, shall be kept on file by the city clerk, and the person for whom such meter is installed shall pay the actual cost thereof. The cost of meter installation may be collected and paid in the same manner as water rentals are paid. (Ord. 43 §11, 1920).

13.04.120 Plumbing – permit required. No plumber or other person shall turn on any water or connect the city water with any plumbing installed by him unless a permit in writing has been granted by the city clerk, as provided by Section 13.04.050. (Ord. 43 §12, 1920).

13.04.130 Turning water on or off – Fee – Meter installation on service pipe.

A. The fee for turning off or turning on city water shall follow the rate that is in our current water rate case filed with the Public Service of Wisconsin (PSCW) and shall be collected by the clerk, together with the cost of installing any water meter, in the same manner that rentals are collected.

B. No meter shall be installed on any service pipe except by an officer or employee of the city designated for such purpose. (Ord. 43 §13, 1920).

13.04.140 Violation – penalty. Any person who violates any of the provisions of this chapter shall, on conviction, pay a forfeiture of not more than twenty-five dollars together with the costs of prosecution. (Ord. 283 §2, 1977; Ord. 43 §14, 1920).

Chapter 13.08

WATER SERVICE TO AREAS PRIOR TO ANNEXATION

Sections:

- 13.08.010 Annexation required.
- 13.08.020 Exceptions

13.08.010 Annexation required. Except as provided in section 13.08.020, City water shall not be extended to any territory outside the City before a petition for annexation has been filed and the territory has been annexed to the City. (Ord. 07OR004)

13.08.020 Exceptions. City water may be extended to territory outside the City before the territory has been annexed to the City in cases of extreme hardship or dire emergency such as a contaminated well, but only after a petition for annexation has been filed. (Ord. 07OR004)

Chapter 13.10LEAD SERVICE LINE REPLACEMENTSections:

13.10.010	Intent and Purpose
13.10.020	Authorization
13.10.030	Rules of Construction and Definitions
13.10.040	Survey and Self-Inspections
13.10.050	Lead Service Line Replacement
13.10.060	Replacement Priority
13.10.070	Scheduling
13.10.080	Financing of Replacement
13.10.090	Exceptions
13.10.100	Prohibitions
13.10.110	Penalties
13.10.120	Severability

13.10.010 Intent and Purpose. Lead service lines pose a threat to the public health based on the potential for leeching of lead into drinking water. Therefore, it is in the public interest to establish a comprehensive program for the removal and replacement of lead pipe water service lines in use within the City of Viroqua water utility system. The purpose of this Chapter is as follows:

- A. To ensure that the water quality at every tap of city water utility customers meets the water quality standards specified under the federal Safe Drinking Water Act.
- B. To reduce the lead in city drinking water to meet EPA standards in city drinking water for the health of city residents.
- C. To meet the WDNR requirements for local compliance with the EPA's Lead and Copper Rule.
- D. To replace all high-risk lead service lines within one year of their discovery and all remaining lead pipe water service lines in use in the City of Viroqua within five (5) years.

13.10.020 Authorization. This Chapter is enacted pursuant to Wis. Stat. §§ 62.11(5) and 281.12(5), and is mandated by 42 U.S.C. § 300g, of the Federal Safe Drinking Water Act, enforced by the EPA and the WDNR.

13.10.030 Rules of Construction and Definitions. This Chapter and all rules and orders promulgated under this Chapter shall be liberally construed so that the purposes enumerated in Section 13.10.010 may be accomplished. Words and phrases shall be construed and understood according to their common and usual meaning unless the contrary is clearly indicated. Within this Chapter the following definitions apply:

- A. CHILDCARE FACILITY means any state licensed or county certified childcare facility including, but not limited to, licensed family childcare, licensed group centers, licensed day camps, certified school- age programs and Head Start programs.
- B. CITY means the City of Viroqua.
- C. CONFIRMED WATER SAMPLE TEST means a tap water analysis completed after a prior analysis that indicated lead levels at the EPA Action level and conducted in accordance with the Lead and Copper Rule, with Wis. Admin. Code§ NR 809.547 and with instructions provided by the water utility.
- D. CURB STOP means the water utility shut-off valve usually located behind the curb on public property.
- E. EPA means the U.S. Environmental Protection Agency.
- F. EPA ACTION LEVEL means a concentration of fifteen (15) or more parts per billion (ppb) of lead as measured at a customer's tap.
- G. FEDERAL SAFE DRINKING WATER ACT means 42 U.S.C.A. § 300f-300j-26.
- H. GOOSENECK means an S-shaped section of pipe that provides flexibility for movement of the service or water main without breaking the connection.
- I. FORMERLY PRESENT means removal of the service or gooseneck before the enactment of this ordinance.
- J. PUBLIC WORKS DIRECTOR means the City of Viroqua Public Works Director.
- K. HIGH-RISK LEAD SERVICE means a lead private-side water service line identified in Section 13.10.050 and any lead private-side water service line where a confirmed water sample test of a customer's tap water reveals a lead concentration at or above the EPA action level.
- L. LEAD AND COPPER RULE means the rule created by the EPA and adopted by the WDNR in response to the passage of the Safe Drinking Water Act, which provides maximum contaminant level goals and national primary drinking water regulations (NPDWR) for controlling lead and copper in drinking water. NPDWR regarding approved treatment techniques include corrosion control treatment, source water treatment, lead service line replacement and public education. The rule may be found in 56 FR 26460, 40 CFR §§ 141.80-141.90, and Wis. Admin. Code §§ NR 809.541-809.55.

M. LICENSED PLUMBER means a person, firm, corporation or other entity licensed to perform plumbing work in the City by the State of Wisconsin.

N. PPB means parts per billion.

O. PRIVATE-SIDE WATER SERVICE LINE means the water conduit pipe running from the customer's meter to the curb stop which is the water utility shut-off valve usually located behind the curb on public property.

P. PROPERTY means any possessory interest, legal or equitable, in real property including an estate, trust, or lien, and any buildings, structures and improvements thereon.

Q. SERVICE REPLACEMENT SCHEDULE means the schedule adopted by the water utility for the replacement of lead private-side water service lines based on community resources, on availability of licensed plumbers and water utility resources to complete service line replacements, and on physical location of properties with lead private-side water service lines. Based on the above factors, customers will be assigned a time period within the schedule for replacing their lead private-side water service line. In no case shall a customer on this schedule have less than thirty (30) days from the date of notification pursuant to 13.10.060 for the replacement of any lead private-side water service line.

R. WATER UTILITY means the city public water utility system, also known as Viroqua Utilities.

S. UTILITY-SIDE WATER SERVICE LINE means the water conduit pipe running from the water main to the curb stop. The utility-side water service includes also include a gooseneck if used to connect the service to the main.

T. WDNR means the Wisconsin Department of Natural Resources.

13.10.040 Survey and Self-Inspections. Upon notice from the water utility, any person who owns, manages or otherwise exercises control over a property within the city water utility system shall allow the water utility to inspect the private-side water service line or have the private-side water service line inspected by a licensed plumber to determine whether the service line is lead, copper, cast iron, galvanized steel, plastic or other material.

13.10.050 Lead Service Line Replacement.

A. All of the following service line material combinations are subject to partial or full replacement with galvanized, copper, and/or plastic service lines under this Chapter as identified:

Utility-side	Private-side	Side Requiring Replacement
Lead service line or gooseneck	Lead	Both
Currently present lead service line or gooseneck	Galvanized	Both
Formerly present lead service line	Galvanized	Customer Only
Formerly present lead gooseneck	Galvanized	No replacement needed
Lead	Copper or Plastic	Water Utility Only
Copper	Lead	Customer Only

No other service line material combinations have been identified which require replacement under this Chapter.

B. All lead water service lines must be replaced, regardless of whether on the utility-side or the private-side, if the utility-side service is lead. Private-side services must be replaced at the time water utility is replacing its side of the lead water service line. As of the effective date of this Chapter, no private- side lead service line will be allowed to connect to a water utility line.

13.10.060 Replacement Priority. Owners, managers or persons otherwise exercising control over properties within the city water utility system with private-side lead water service lines shall be required to replace the private-side water service lines according to the following order of priority and based on the replacement schedule established by the water utility:

- A. Schools or childcare facilities.
- B. Properties at which a confirmed water sample test at the tap shows lead concentration at fifteen (15) or more ppb.
- C. Properties where more than twenty (20) people regularly have access to drinking water during any eight (8) hour period.
- D. Properties where the water utility is replacing its side of the lead water service line to the property.
- E. All other properties not covered in Subsections 13.10.060(A)-(D).

Notwithstanding the schedules set forth herein and any limitations on funding sources which may be made available to either the water utility or the customer, all private-side water service lines identified herein shall be replaced no later than December 31, 2025.

13.10.070 Scheduling. Replacement of private-side lead pipes that are connected to a utility-side lead service line must be completed at the time the utility-side service line is replaced. Scheduling of all such replacements for private-side lead pipes must be coordinated between the homeowner's contractor and the water utility within thirty (30) days of receipt of notice that the utility-side water service lines are scheduled to be replaced. Additional time to schedule the private-side lead pipe replacement may be granted by the Public Works Director of the water utility for good cause.

13.10.080 Financing of Replacement. In the event funding is made available for this purpose through any means, an eligible property owner may apply to the city for financing of any portion of the cost of replacing a lead private-side water service line under the terms of such financing program. Disputes regarding eligibility for financing may be appealed to the water utility commission, unless otherwise noted in the funding program. As a condition of receiving any available financing from the City, the property owner must provide adequate documentation demonstrating that the contractor and/or plumber completing the work anticipated hereunder is properly certified and/or licensed by the state and/or the city, as appropriate.

13.10.90 Exceptions.

A. The water utility may modify the inspection requirement set forth under Section 13.10.040 if the customer so requests and demonstrates compelling need.

B. Upon the demonstration of compelling need, the owner of a single-family dwelling or a business to which the public has no access to tap water and with no more than five (5) employees, may request a change of schedule or an extension of time for compliance with Sections 13.10.050-13.10.070.

C. Guidelines for the consideration of requests under Subsections 13.10.090(A) and (B) will be established by the water utility commission.

D. Compliance deadlines will be calculated on a calendar year basis but may be deferred during the month through March on the basis of weather constraints.

13.10.100 Prohibitions. It shall be unlawful for any person to fail to comply with the applicable lead private-side water service line replacement requirements as set forth herein or to violate any other provision of this Chapter.

13.10.110 Penalties. Any person who violates any provision of this chapter may be subject to a forfeiture of no less than \$50 and no more than \$1,000. Each day a violation continues may be considered a separate offense.

13.10.120 Severability. If any portion of this Chapter is for any reason held to be invalid or unconstitutional by a decision of a court of competent jurisdiction, that portion shall be deemed severable and shall not affect the validity of the remaining portions of this Chapter.

Chapter 13.12FIRE HYDRANTSSections:

13.12.01	0	Intent.
13.12.02	0	Definitions.
13.12.030		Fire and police departments – Authority during emergency.
13.12.040		Fire and police departments – Responsibilities generally.
13.12.050		Other city departments - Authorization to use.
13.12.060		Other city departments - Use to be metered - Alternatives.
13.12.065		Privately owned fire hydrants.
13.12.070		Violation - Penalty.

13.12.010 Intent. It is not the intention of this chapter to restrict in any way the emergency use of any fire hydrant or associated equipment by the fire department, or the normal use of hydrants by other city personnel which benefit the populace or by other persons authorized by the water department superintendent for such purposes as weed spraying, construction, maintenance flushing, and similar activities. (Ord. 250 §1, 1973).

13.12.020 Definitions. As used in this chapter, the following definitions shall apply:

A. "Authorized persons" means any member of the fire department during times of fires and/or other impending emergency situations, or any employees of the city when the dictates of their jobs necessitate the use of a fire hydrant for public need.

Upon request, the water department superintendent may authorize certain other persons, such as contractors, other government entities, bulk milk haulers, Vernon County Fair Association officials, and similar persons, to use certain fire hydrants for specific reasons on a short period of time basis.

B. "Emergency" and/or "impending emergency" means any situation such as, but not limited to, fire, explosion, fuel spills or migrant combustible mixtures; or means any time that the safety of human life and/or property is threatened.

C. "Unauthorized persons" means any individual and/or firms not specifically authorized by this chapter, except, however, no authorization shall be required by any person acting in the public good during times of emergency. (Ord. 250 §2, 1973).

13.12.030 Fire and, police departments - Authority during emergency.

A. Any member of the fire department or the police department shall have authority to use any fire hydrant on the water system during times of emergency.

B. Any person designated orally or otherwise by members of the fire department (normally the chief) or members of the police department shall have temporary authority to use any fire hydrant on the water system during times of emergency. (Ord. 250 §4(A), 1973).

13.12.040 Fire and police departments - Responsibilities generally. A. It shall be the responsibility of the fire chief or his appointee to file with the superintendent of the water department the appropriate form within twelve hours (or sooner if in freezing temperatures) of using any fire hydrant for emergency purposes.

B. The requirement set forth in subsection A of this section shall be fulfilled by the chief of police should a hydrant be used under the direction of the police department and the fire department was not present.

C. The police department shall, during patrol, observe fire hydrant installations and report any suspected violation to the water department superintendent.

D. Drills and other practice sessions, including the flushing of fire hydrants, do not constitute emergency use and therefore prior notice shall be submitted to the water department superintendent so that arrangements can be made regarding additional pumping of wells.

E. Any fire hydrant noticed by the fire and/or the police department that appears to need repair shall be reported immediately to the superintendent of the water department. (Ord. 250 §4(B), 1973).

13.12.050 Other city departments - Authorization to use.

A. Street department employees shall, under the direction of the superintendent of streets, be authorized to use water from fire hydrants for purposes directly associated with city work, such as street cleaning.

B. Recreational department employees, under the direction of the department head responsible for the specific activity, shall be authorized to use water from fire hydrants only for the specific purpose that the water is needed.

C. Utility employees, under the direction of the utility superintendent(s), shall be authorized to use water from fire hydrants to complete their necessary duties. (Ord. 250 §5(A), 1973).

13.12.060 Other city departments - Use to be metered - Alternatives. In as much as is possible, all use of water shall be metered. Where it is impossible or unfeasible, in the judgment of the water department superintendent, to meter the water, the following shall prevail:

A. The street department superintendent or his appointee shall submit appropriate forms to the water department superintendent as requested.

B. The various department heads responsible for recreational use of water shall submit appropriate forms to the water department superintendent as requested.

C. Utility employees shall fill out appropriate forms concerning water usage as requested. (Ord. 250 §5(B), 1973).

13.12.065 Privately owned fire hydrants

A. Privately owned fire hydrants connected to the municipal water system shall be periodically checked by the City to ensure that the hydrants are in operational order and do not pose any risk to the water system. The owner of a fire hydrant connected to the municipal water system shall, upon written notice, allow access to the hydrant by the City, and shall allow the hydrant to be examined and tested. In the event inspection reveals any deficiency in the hydrant, the owner shall be given written notice thereof, including the nature of the deficiency and the time within which corrections must be made.

B. Any person who violates the provisions of this subsection shall be subject to the penalty of this chapter, and in addition the person's fire hydrant shall be disconnected from the municipal water system until the necessary corrections shall have been made. (Ord 07OR006)

13.12.070 Violation-Penalty. Any person, firm, company or corporation who violates, disobeys or refuses to comply with, or who resists the enforcement of any of the provisions of this chapter shall, upon conviction, forfeit not less than twenty-five dollars nor more than two hundred dollars for each offense, together with the cost of prosecution, the cost of any repair to any fire hydrant resulting from such violation, and the cost of any water taken and/or let from any fire hydrant; and, in default of payment of such forfeiture and costs, shall be imprisoned in the county jail until said forfeiture and cost are paid, but not to exceed thirty days for each violation. Each violation shall constitute a separate offense. (Ord 250, 1973)

Chapter 13.20SEWER USE AND USER CHARGESSections:

13.20.010	Definitions.
13.20.020	Management, operation, and control.
13.20.030	User rules and regulations.
13.20.040	Regulation.
13.20.050	Sewer service charge system.
13.20.060	Control of industrial and septage wastewaters.
13.20.070	Payment for charges.
13.20.080	Audit.
13.20.090	Violations and penalties.
13.20.100	Repeal and validity.

13.20.010 Definitions. Unless the context specifically indicates otherwise, the meaning of terms used in this Ordinance shall be as follows:

1. APPROVING AUTHORITY shall mean the City Council of the City of Viroqua, or its duly authorized committee, agent or representative.

2. AMMONIA NITROGEN (NH₃-N) shall mean one of the oxidation states of nitrogen, in which nitrogen is combined with hydrogen in molecular form as NH₃ or in ionized form as NH₄. Quantitative determination of ammonia nitrogen shall be made in accordance with procedures set forth in the most recent edition of "Standard Methods".

3. BIOCHEMICAL OXYGEN DEMAND (BOD) shall mean the quantity of oxygen utilized in the biochemical oxidation of organic matter in five (5) days at 20 degrees Centigrade, expressed in milligrams per liter. Quantitative determination of BOD shall be made in accordance with procedures set forth in the most recent edition of "Standard Methods".

4. BUILDING DRAIN shall mean that part of the lowest horizontal piping of a drainage system which receives the discharge from waste and other drainage pipes inside the wall of the building and conveys it to the building sewer, beginning approximately five feet outside the inner face of the building wall.

5. BUILDING SEWER, also referred to as the lateral, shall mean the extension from the building drain to the sewer system. Except as specifically provided in this Ordinance, the City shall not be responsible for the construction and maintenance of building sewers or laterals.

6. CHEMICAL ELEMENTS & COMPOUNDS that are typically found in wastewater and may be regulated by this ordinance.

Ammonia Nitrogen	NH ₃
Arsenic	As
Cadmium	Cd
Copper	Cu
Chromium	Cr
Cyanide	Cn
Lead	Pb
Mercury	Hg
Nickel	Ni
Nitrogen	N
Phosphorus	P
Radium	Ra
Zinc	Zn

7. CHEMICAL OXYGEN DEMAND (COD) shall mean the quantity of oxygen utilized in chemical oxidation of both organic and inorganic matter expressed in milligrams per liter. Quantitative determination of COD shall be made in accordance with procedures set forth in the most recent edition of "Standard Methods".

8. COMMERCIAL USER shall mean any user whose premises are used primarily for the conduct of a profit-oriented enterprise in the fields of construction, wholesale or retail trade, finance, insurance, real estate or services, and who discharges primarily, normal domestic sewage.

9. COMPATIBLE POLLUTANTS shall mean biochemical oxygen demand, chemical oxygen demand, suspended solids, phosphorus, nitrogen or pH, plus additional pollutants identified in the WPDES permit for the wastewater treatment works receiving the pollutant, if such works were designed to treat such additional pollutants to a substantial degree.

10. EASEMENT shall mean an acquired legal right for the specific use of land owned by others.

11. FLOATABLE OIL shall mean oil, fat or grease in a physical state such that it will separate by gravity from wastewater by treatment in an approved pretreatment facility. A wastewater or septage shall be considered free of floatable fat if it is properly pretreated and the wastewater does not interfere with the collection or treatment systems.

12. GARBAGE shall mean the residue from the preparation, cooking and dispensing of food, and from the handling, storage and sale of food products and produce.

13. GROUND GARBAGE shall mean the residue from the preparation, cooking and dispensing of food that has been shredded to such degree that all particulates will be no greater than one-half ($\frac{1}{2}$) inch in any dimension and will be carried freely in suspension under normal flow conditions in sewers.

14. HOLDING TANK SERVICE AREA shall mean the area outside the City's sewer service area, but inside or equal to the City's planning area where a contract has been developed for holding tank wastewater to be treated at the wastewater treatment works.

15. INCOMPATIBLE POLLUTANTS OR WASTEWATER shall mean wastewater or septage with pollutants that will adversely affect or disrupt the wastewater treatment processes, effluent quality or sludge quality if discharged to the wastewater facilities.

16. INDUSTRIAL USER shall mean any user whose premises are used primarily for the conduct of a profit-oriented enterprise in the fields of manufacturing, dairy products processing, meat processing, other food and drink products, painting or finishing operations, transportation, communications or utilities, mining, agriculture, forestry, or fishing.

17. INDUSTRIAL WASTE shall mean the wastewater from an industrial process, trade, or business, as distinct from sanitary sewage, including cooling water and the discharge from pretreatment facilities.

18. LICENSED DISPOSER shall mean a person or business holding a valid license to do septage servicing under Wisconsin Administrative Code NR 113.

19. MAY is permissible.

20. MILLIGRAMS PER LITER (mg/L) shall be a weight-to-weight ratio; the milligrams per liter value (mg/L) multiplied by the factor 8.34 shall be equivalent to pounds per million gallons of water.

21. MUNICIPAL WASTEWATER shall mean the wastewater of a community. From the standpoint of source, it may be a combination of the liquid and water-carried wastes from residences, commercial buildings, industrial plants and institutions, together with any groundwater, surface water and stormwater that may have inadvertently entered the sewer system.

22. NATURAL OUTLET shall mean any outlet, including storm sewers, into a water course, pond, ditch, lake or other body of surface water or groundwater.

23. NORMAL DOMESTIC SEWAGE shall mean sanitary sewage resulting from the range of normal domestic activities, in which BOD, COD, SS, total nitrogen, ammonia nitrogen and total phosphorus concentrations meet the following:

- a) A BOD of not more than 250 mg/L.
- b) A COD of not more than 750 mg/L. mg/L
- c) A suspended solids content of not more than 250 mg/L.
- d) A total nitrogen content of not more than 40 mg/L.
- e) An ammonia nitrogen content of not more than 25 mg/L.
- f) A total phosphorus content of not more than 7 mg/L.

24. PARTS PER MILLION (ppm) shall mean a weight-to-weight ratio; the parts per million value multiplied by the factor 8.34 shall be equivalent to pounds per million gallons of water. Equivalent to milligrams per liter (mg/L).

25. PERSON shall mean any and all persons, including any individual, firm, company, municipal or private corporations, association, society, institution, enterprise, government agency or other entity.

26. Ph shall mean logarithm of the reciprocal of the hydrogen ion concentration. The concentration is the weight of hydrogen ions, in grams per liter of solution. Neutral water, for example, has a pH value of 7 and a hydrogen ion concentration of 10^{-7} .

27. PRETREATMENT shall mean an arrangement of devices and structures, for the preliminary treatment or processing of wastewater required to render such wastes acceptable for admission to the public sewers.

28. PRIVATE SEWER shall mean any sewer outside of a public right of way or public easement. Except as provided in this Ordinance, a private sewer shall not be subject to the jurisdiction of the City and the City shall not be responsible for the construction and/or maintenance of such sewer.

29. PUBLIC SEWER shall mean any sewer provided by or subject to the jurisdiction of the City of Viroqua. It shall also include sewers within or outside the corporate boundaries that serve more than one person and ultimately discharge into the City sanitary sewer system, even though those sewers may not have been constructed with City funds. Public sewers shall not include private sewers or building sewers.

29.1 RESIDENTIAL EQUIVALENT UNIT ("REU") shall mean the equivalent usage of one residential customer. REUs for the commercial, industrial, and public authority rate classes should be calculated annually based upon the average consumption of the residential rate class. (Ord. 539, 2003)

30. SANITARY SEWAGE shall mean a combination of water-carried wastes from residences, commercial buildings, institutions and industrial plants (other than industrial wastes from such plants), together with such ground, surface and storm waters as may be present.

31. SANITARY SEWER shall mean a sewer that carries sanitary and industrial water-carried wastes from residents, commercial buildings, industrial plants, and institutions, together with minor quantities of ground, storm and surface water that are not admitted intentionally.
32. SEPTAGE shall mean the wastewater or contents of septic or holding tanks, dosing chambers, seepage beds, seepage pits, seepage trenches, privies or portable restrooms.
33. SEWAGE is the spent water of a community. The preferred term is "municipal wastewater".
34. SEWER SERVICE AREAS are the areas presently served and anticipated to be served by a municipal wastewater collection system. The sewer service area is delineated in the most recently approved Facility Plan.
35. SEWER SERVICE CHARGE is a service charge levied on users of the wastewater collection and treatment facilities for payment of capital expenses as well as the operation, maintenance costs, and replacement of said facilities.
36. SEWER SYSTEM means the common sanitary sewers within a sewerage system which are primarily installed to receive wastewaters directly from facilities which convey wastewater from individual structures or from private property, and which include service connection "Y" fittings designed for connection with those facilities. The facilities which convey wastewater from individual structures, from private property to the public sanitary sewer, or its equivalent, are specifically excluded from the definition of "sewerage collection system"; except that pumping units and pressurized lines for individual structures or groups of structures may be included as part of a "sewer system" when such units are cost-effective and are owned and maintained by the City.
37. SEWERAGE SYSTEM means all structures, conduits and pipes, by which sewage is collected, treated, and disposed of, except plumbing inside and in connection with buildings served, and service pipes, from building to street main.
38. "SHALL" is mandatory.
39. SLUG LOAD shall mean any substance released at a discharge rate and/or concentration which causes interference to wastewater treatment processes or plugging or surcharging of the sewer system.
40. STANDARD METHODS shall mean the examination and analytical procedures set forth in the most recent edition of "Standard Methods for the Examination of Water and Wastewater", published jointly by the American Public Health Association, the American Water Works Association and the Water Environment Federation.

41. STORM DRAIN (sometimes termed "storm sewer") shall mean a drain or sewer for conveying surface water, groundwater, subsurface water, or unpolluted water from any source.

42. STORMWATER RUNOFF shall mean that portion of the rainfall that is collected and drained into the storm sewers.

43. SUSPENDED SOLIDS (SS) shall mean solids that either float on the surface of, or are in suspension in, water, wastewater, septage, or other liquids, and that is removable by laboratory filtering as prescribed in "Standard Methods" and is referred to as nonfilterable residue.

44. TOTAL NITROGEN (TN) shall mean the sum of nitrate, nitrite, organic nitrogen and ammonia (all expressed as N). Quantitative determination of total nitrogen shall be made in accordance with procedures set forth in the most recent edition of "Standard Methods".

45. TOTAL PHOSPHORUS (TP) shall mean both inorganic and organic forms of phosphorus present as dissolved or particulate. Quantitative determination of total phosphorus shall be made in accordance with procedures set forth in the most recent edition of "Standard Methods".

46. TOXIC DISCHARGES means a discharge containing a substance or mixture of substances which, through sufficient exposure, or ingestion, inhalation, or assimilation by an organism, either directly from the environment or indirectly by ingestion through the food chain, will, on the basis of information available to the City, cause death, disease, behavioral or immunological abnormalities, cancer, genetic mutations, or developmental or physiological malfunctions, including malfunctions in reproduction or physical deformations, in such organisms or their offspring.

47. USER CLASSES are categories of users having similar flows and water characteristics; that is, levels of biochemical oxygen demand, suspended solids, nitrogen, etc. For the purposes of this ordinance, there shall be four user classes: residential, commercial, industrial and public authority.

48. WASTEWATER FACILITIES shall mean the structures, equipment and processes required to collect, carry away, store, and treat domestic and industrial waste and septage and dispose of the effluent and sludge.

49. WASTEWATER TREATMENT WORKS shall mean an arrangement of devices and structures for treating wastewater, septage, industrial waste and sludge. Sometimes used as synonymous with sewage treatment facility.

50. WATER COURSE shall mean a natural or artificial channel for the passage of water, either continuously or intermittently.

51. WPDES: Wisconsin Pollutant Discharge Eliminator System permit, issued per Wisconsin Administrative Code NR210. (ORD 440 1993)

13.20.020 Management, operation, and control.

A. AUTHORITY. The management, operation and control of the wastewater facilities of the City of Viroqua is vested in the City Council; all records, minutes and all written proceedings thereof shall be kept by the City Clerk. The City Clerk or other authorized representative shall keep all the financial records.

B. CONSTRUCTION. The City Council shall have the power to construct sewer lines for public use, and shall have the power to lay sewer pipes in and through the alleys, streets and public grounds of the City; and generally, to do all such work as may be found necessary or convenient in the management of the wastewater facilities. The City Council shall have power by themselves, their officers, agents and representatives to enter upon any land for the purpose of making examination in the performance of their duties under this Ordinance, without liability therefore; and the City Council shall have power to purchase and acquire for the City any real and personal property which may be necessary for construction of the wastewater facilities, or for any repair, remodeling, or additions thereto.

C. MAINTENANCE OF SERVICES. The property owner shall maintain the building sewer from the sewer system to the building and including all controls between the same, without expense to the City, except when they are damaged as a result of negligence or carelessness on the part of the City. All building sewers must be maintained free of defective conditions, by and at the expense of the owner or occupant of the property. When any is to be relaid and there are two or more buildings on such service, each building shall be disconnected from such sewer and a new building sewer will be installed for each building.

D. CONDEMNATION OF REAL ESTATE. Whenever any real estate or any easement therein, or use thereof, shall in the judgment of the City Council be necessary to the wastewater facilities, and whenever, for any cause, an agreement for the purchase thereof, cannot be made with the Owner thereof, the City Council shall proceed with all necessary steps to take such real estate, easement, or use by condemnation in accordance with the Wisconsin Statutes and the Uniform Relocation and Real Property Acquisition Policy Act of 1970, if Federal Funds are used for the project associated with the real estate or easement.

E. TITLE TO REAL ESTATE AND PERSONALTY. All property, real, personal and mixed, acquired for the construction of the wastewater facilities, and all diagrams, papers, books and records connected therewith said wastewater facilities, and all buildings, machinery and fixtures pertaining thereto, shall be the property of the City of Viroqua. (ORD 440 1993)

13.20.030 User rules and regulations.

A. GENERAL. The rules, regulations and sewer rates of the City of Viroqua, hereinafter set forth, shall be considered a part of the contract with every person, company or corporation who is connected to or uses the sewer system or wastewater treatment works and every such person, company or corporation by connecting with the sewer system or wastewater treatment works shall be considered as expressing their assent to be bound thereby. Whenever any of said rules and regulations, or such others as the City Council may hereinafter adopt, are violated, the use or service shall be shut off from the building or place of such violation (even though two or more parties are receiving service through the same connection) and shall not be re-established except by order of the City Council and on payment of all arrears, the expenses and charges of shutting off and putting on, and such other terms as the City Council may determine, and a satisfactory understanding with the party that no further cause for complaint shall arise. In case of such violation, the City Council, furthermore, may declare any payment made for the service by the party or parties committing such violation, to be forfeited, and the same shall thereupon be forfeited. The right is reserved to the City Council to change these said rules, regulations and sewer rates from time to time as they may deem advisable; and make special contracts in all proper cases.

The following rules and regulations for the government of licensed plumbers, sewer users and others, are hereby adopted and established.

B. PLUMBERS. No plumber, pipe fitter, or other person will be permitted to do any plumbing or pipe fitting work in connection with the sewer system without first receiving a license from the State of Wisconsin and obtaining permission from the City Council. All service connections to the sewer main shall comply with the State Plumbing Code.

C. PRIVATE SYSTEMS PROHIBITED.

1. SEPTIC TANKS PROHIBITED. The maintenance and use of septic tanks, holding tanks and other private sewage disposal systems within the area of the City serviced by its sewer system are hereby declared to be a public nuisance and a health hazard. From and after June 30, 1993, the use of septic tanks, holding tanks or any other private sewage disposal system within the area of the City serviced by the sewer system shall be prohibited.

2. MANDATORY HOOK-UP. The owner of each parcel of land adjacent to a sewer main on which there exists a building usable for human habitation or in a block through which such system is extended, shall connect to such system within 90 days of notice in writing from the City Council. Upon failure to do so, the City Council may cause such connection to be made and bill the property owner for such costs. If such costs are not paid within 30 days, such costs shall be assessed as a special tax lien against the property; provided, however, that the owner may within 30 days after the completion of the work file a written option with the City Council stating that he or she cannot pay such amount in one sum and ask that the cost be levied in not to exceed 10 equal installments and that the amount shall be so collected with interest at the rate of eight percent per annum from the completion of the work, the unpaid balance being a special tax lien, all pursuant to Section 144.06, Wisconsin Statutes.

In lieu of the above, the City at its option may impose a penalty for the period that the violation continues, after 10 days written notice to any owner failing to make a connection to the sewer system, of a fine in the amount of \$5.00 per day. Upon failure to make such payment, said charge shall be assessed as a special tax lien against the property, all pursuant to Section 144.06.

This ordinance ordains that the failure to connect to the sewer system is contrary to the minimum health standards of the City and fails to assure preservation of public health, comfort, and safety of the City.

3. DELAYED CONNECTION. Upon application filed with the City Council by the owner of a building subject to the connection requirement of this section, the City Council may, upon recommendation of the Public Works Committee, order a delayed connection of the building with the water main, beyond the 90 day deadline, upon making a determination that a specified delay will not be detrimental to the preservation of public health and the comfort and safety of City residents. If the City Council orders a delayed connection under this subsection, the delayed connection shall be authorized in writing and shall be for a specified period of time and may be subject to certain conditions. Upon the expiration of the specified period, or the occurrence of any of the conditions set forth in the order, the delay shall expire and the building shall be connected to the water main within ten (10) days, or as otherwise agreed to by the owner and the City Council. If the building is not connected within ten (10) days, or as otherwise agreed to by the owner and the City Council, the City Council may avail itself of any of the remedies set forth in Subsection 13.20.030(C)(2), supra.

D. APPLICATIONS FOR SERVICE

1. APPLICATION FOR SEWER SERVICE. Every person desiring to connect to the sewer system shall file an application in writing to the City Clerk on such form as is prescribed for that purpose. The application must state fully and truthfully all the wastes which will be discharged. If the applicant is not the owner of the premises, the written consent of the owner must accompany the application. Persons connected to the sewer system of the City are referred to herein as "Users".

If it appears that the service applied for will not provide adequate service for the contemplated use, the City Council may reject the application. If the Utilities Office approves the application, it shall issue a permit for services as shown on the application upon payment of the connection charge.

City sewer shall not be extended to any territory outside the City before a petition for annexation has been filed and the territory has been annexed to the City, except in cases of extreme hardship or dire emergency such as a failed septic system, but only after a petition for annexation has been filed. (Ord. 07OR004)

2. APPLICATION FOR SEPTAGE DISPOSAL. Between August 1 and September 1 of each year, each licensed disposer wishing to discharge septage to the City wastewater treatment works shall file a nonrefundable filing fee and an application in writing to the Utilities Office on such form as prescribed for that purpose. During the months of July and August, forms for such application will be furnished at the Utilities Office. The application must state fully and truly the type; frequency, quantity, quality and location of generated septage to be disposed in the wastewater treatment works.

During the month of September, the City Council will evaluate the applications and make a determination as to the amount and conditions of septage disposal. The City Council shall approve or reject all applications by October 1 of each year. If the City cannot accept all of the proposed septage disposal, then consideration shall be given first to those generators of septage that are within the sewer service or holding tank service areas (see NR 205.07(2)(e)).

The person(s) or party disposing waste shall furnish bond to the City in the amount of \$1,000.00 to guarantee performance. Said performance bond shall be delivered to the Utilities Office prior to the issuance of the permit hereunder. Any person or party disposing of septage agrees to carry public liability insurance in an amount not less than one hundred thousand dollars (\$100,000.00) to protect any and all persons or property from injury and/or damage caused in any way or manner by any act, or failure to act, by any of his employees. The person(s) shall furnish a certificate certifying such insurance to be in full force and effect.

All City Council approvals for septage disposal shall have the condition that any time the sewerage system has operational problems, maintenance problems or threat of WPDES permit violations that are indirectly or directly related to septage disposal, the City may immediately restrict septage disposal until such time as corrective action or mitigative measures have been taken.

3. CONNECTION CHARGE.

(13) First Connection. Persons attaching to a public sewer which involves a new physical attachment to the main shall pay a connection charge of \$500.00 and shall have the building sewer from the sewer main installed at their own expense. (ORD 545, 2003)

(ii). Subsequent connections. Persons attaching to a public sewer which does not involve a new physical attachment to the main shall pay a connection charge equal to 50% of the charge for a first connection and shall have the building sewer from the sewer main installed at their own expense. (ORD 545, 2003)

E. USE OF SEWERS

1. USER TO KEEP IN REPAIR. All users shall keep their own building sewers in good repair and protected from frost, at their own risk and expense, and shall prevent any unnecessary overburdening of the sewer system.

2. BACKFLOW PREVENTOR. In areas where sewer main surcharging is known to occur, all floor drains shall have a backflow prevention valve installed at the owner's expense.

3. USER USE ONLY. No user shall allow other persons or other services to connect to the sewer system through their building sewer.

4. VACATING SEWER OF PREMISES AND DISCONTINUANCE. Whenever premises served by the system are to be vacated, or whenever any person desires to discontinue service from the system; the Utilities Office must be notified in writing.

5. USER TO PERMIT INSPECTION. Every user shall permit the City or its duly authorized agent, at all reasonable hours of the day, to enter their premises or building to examine the pipes and fixtures, and the manner in which the drains and sewer connections operate; and they must at all times, frankly and without concealment, answer all questions put to them relative to its use, all in accordance with this Ordinance and Section 196.171, Wisconsin Statutes.

F. UTILITY RESPONSIBILITY. It is expressly stipulated that no claim shall be made against the City or acting representative by reason of the breaking, clogging, stoppage, or freezing of any service pipes; nor from any damage arising from repairing mains, making connections or extensions or any other work that may be deemed necessary. The right is hereby reserved to cut off the service at any time for the purpose of repairs or any other necessary purpose, any permit granted or regulations to the contract notwithstanding. Whenever it shall become necessary to shut off the sewer within any district of the City, the Utilities Office shall, if practicable, give notice to each and every consumer within the affected area of the time when such service will be shut off.

G. BUILDING SEWER CONSTRUCTION

1. EXCAVATIONS. In making excavations in streets or highways for laying building sewers or making repairs, the paving and the earth removed shall be deposited in a manner that will result in the least inconvenience to the public.

No person shall leave any such excavation made in any street or highway open at any time without barricades; and, during the night, warning lights must be maintained at such excavations.

In refilling the opening, after the pipes are laid, the earth must be laid in layers of not more than nine inches in depth, and each layer thoroughly compacted to prevent settling. This work, together with the replacing of sidewalks, base course and paving, must be done so as to make the street as good, at least, as before it was disturbed, and satisfactory to the City. No opening of the streets for tapping the pipes will be permitted when the ground is frozen.

2. TAPPING THE MAINS. No persons, except those having special permission from the City or persons in their service and approved by them, will be permitted, under any circumstances, to tap the public sewer or collection pipes. The kind and size of the connection with the pipe shall be that specified in the permits from the City, to ensure that new sewers and connections to the sewer system are properly designed and constructed.

Pipes should always be tapped on top, and not within six inches (15cm) of the joint, or within 24 inches (60 cm) of another lateral connection. All service connections to mains must comply with State Plumbing Code. Lateral connections to existing sewers shall be made into saddles and by coring the existing sewer or by inserting (cutting-in) a wye or tee into the existing sewer. The wye or tee shall be of the same pipe material as the existing sewer. The lateral/tee connection shall be made with approved adaptors or couplings.

3. INSTALLATION OF BUILDING SEWERS (HOUSE LATERALS). All building sewer pipes (laterals) on private property will be installed in accordance with State of Wisconsin Administrative Code Chapter SPS 382 "Design, Construction, Installation, Supervision, Maintenance and Inspections of Plumbing," Sanitary drain especially, Section SPS 382.30 systems.

All plumbing shall be tested and inspected by the City as required by the Wisconsin administrative code SPS 382.21 "Testing and inspection".

4. CLEARWATER CONNECTION PROHIBITED. No person shall make connections of roof downspouts, foundation drains, yard drains, or other sources of surface runoff or groundwater to a building sewer or building drain which is connected directly or indirectly to the public sewer. Any existing connections of surface runoff or groundwater shall be disconnected upon written notice from the City.

5. INSPECTION OF CONNECTION. The applicant for connection shall notify the City when the building sewer is ready for inspection and connection to the public sewer. The actual connection shall be made under the supervision of the City.

H. EXTENSIONS OF SEWER MAINS. The City shall extend sewer mains to a new person(s) in accordance with the following charges and the following conditions:

1. APPLICATION. When an extension of a sewer main is required by the prospective user, said person shall make an application for such an extension in writing to the City Council by filing of a written application. After the filing of such an application, the City Council shall first determine the logical location of the next manhole or manholes. Next, the Council shall determine the length and location of the extension, taking into consideration the prospective demands for service, the capacity of downstream facilities, and the orderly development of the particular area. No extension shall be made for a distance less than to the next manhole. All sewer extensions shall be constructed in compliance with the local and state laws, ordinances and regulations.

2. PAYMENT BY USERS. The person who requests the extension shall pay the entire cost of said extension including the manhole or manholes that are part of the extension. If more than one user is involved, the entire cost shall be divided among these users in the proportion determined by the City Council.

3. METHOD OF DIVIDING COST. After making the decision as to the length and location of the extension and prior to the time of making the charge to the person(s), the City Council shall determine the benefits to be received by any parcel that can be served by said extension. Before making a determination as to the benefits received, the City Council shall first divide the area to be served into logical building lots. The City Council may consider the recommendations of the landowner in determining said building lots if the landowner as part of his or her application accompanies said application with a proposed division of said land into lots for sale or use. In determining the amount to be paid by the original users, if more than one user is involved, the division of the charge shall be made by considering each building lot as a separate user. Payments are to be considered contributions to construction.

4. FUTURE USERS. After the original contribution, any future connection by reason other than to a lot owned by a party making a previous contribution, such user may be required to pay to the City their pro-rata share of the lot or lots owned by the new attaching user in the entire extension cost as if said user had been one of the original contributors. No refund shall be made to the original contributors.

In addition to the charge made as above provided to each lot, each user shall pay the connection charge and the full cost of the building sewer from the main to their building.

I. SEPTAGE ACCEPTANCE LOCATION. Septage shall only be discharged to the City's sewerage system by City-approved and State of Wisconsin licensed disposers and at locations, times and conditions as specified by the City Council.

Septage discharges to the receiving facility at the wastewater treatment works shall be limited to the posted, normal working hours of the facility. Documentation of the discharge shall be submitted to the City within one working day of the discharge.

Septage discharges to specified manholes may, under special circumstances, be allowed provided discharge rates are restricted as necessary to facilitate mixing, prevent a backup in the receiving sewer and prevent a slug load to the wastewater treatment facility. Discharges shall be limited to the normal working hours of the City and be approved in advance of each such discharge.

The forms prescribed for the purpose of documentation of the discharge will be furnished at City's office and will including the following information:

- a. Name, address and telephone number of the hauler.
- b. License number.
- c. Type of septage.
- d. Quantity of septage.
- e. Estimated quality of septage.
- f. Location, date, time and feed rate of discharge.
- g. Source of septage.
- h. Name and address of septage generator.
- i. Other information as requested by the City.

J. ADDITIONAL AUTHORITY. The City Council may at any time establish specific connection and lateral charges for any main not covered by other provisions in this ordinance or when the City Council has made an extension and the City Council has failed to provide lateral or connection charges. It is further provided that the City Council may amend or alter any connection or lateral charge after its establishment under the terms of this Ordinance or previous Ordinance or Resolutions. (ORD 440 1993)

13.20.040 REGULATION.

A. GENERAL DISCHARGE PROHIBITIONS. No person shall contribute or cause to be discharged, directly or indirectly, any of the following described substances into the wastewater facilities of the City:

1. Any liquids, solids or gases which by reason of their nature or quantity are, or may be, sufficient either alone or by interaction to cause fire or explosion or be injurious in any other way to the operation of the wastewater facilities or wastewater treatment works.

2. Solid or viscous substances which will or may cause obstruction to the flow in a sewer or other interference with the operation of the wastewater system.
3. Any wastewater having a pH less than 6.0 or higher than 9.0 or having any other corrosive property capable of causing damage or hazard to structures, equipment, or personnel of the system unless the system is specifically designed to accommodate such wastewater.
4. Any wastewater containing arsenic, cadmium, copper, chromium, cyanide, lead, mercury, nickel, zinc or other toxic pollutants in sufficient quantity, either singly or by interaction, to injure or interfere with any wastewater treatment process, constitute a hazard to humans or animals, or to exceed the limitation set forth in special agreements, State or Federal Categorical Pretreatment Standards.
5. Any noxious or malodorous liquids, gases or solids which either singly or by interaction are capable of creating a public nuisance or hazard to life or are sufficient to prevent entry into the sewers for their maintenance and repair.
6. Any substance which may cause the wastewater treatment works effluent, treatment residues, sludges, or scums to be unsuitable for reclamation and reuse or to interfere with the reclamation process.
7. Any substance which will cause violations of the WPDES and/or other disposal system permits.
8. Any substance with objectionable color not removed in the treatment process, such as, but not limited to, dye wastes and vegetable tanning solutions.
9. Any wastewater having a temperature which will inhibit biological activity in the wastewater treatment works resulting in interference; but in no case, wastewater with a temperature at the introduction into the public sewer which exceeds 120°F unless the wastewater facilities are designed to accommodate such temperature.
10. Any slug load, which shall mean any pollutant, including oxygen-demanding pollutants (BOD or COD), released in a single extraordinary discharge episode of such volume or strength as to cause interference to the wastewater treatment works.
11. Any unpolluted water including, but not limited to, non-contact cooling water.
12. Any wastewaters which may be acutely or chronically toxic to aquatic life or wild and domestic animals.

13. Any wastewater containing any radioactive wastes or isotopes of such half-life or concentration as exceed limits established by the City in compliance with applicable State or Federal regulations.

14. Any wastewater which causes a hazard to human life or creates a public nuisance.

15. Any stormwater, surface water, groundwater, roof run-off or surface drainage or any other connections from inflow sources to the public sewer. Such waters may be discharged to a storm sewer or other waterway with permission of the City Council.

B. LIMITATIONS ON WASTEWATER STRENGTH

1. NATIONAL CATEGORICAL PRETREATMENT STANDARDS shall, as promulgated by the U.S. Environmental Protection Agency, be met by all dischargers of the regulated industrial categories.

2. STATE REQUIREMENTS and limitations on discharges to the wastewater facilities shall be met by all dischargers which are subject to such standards in any instance in which they are more stringent than other applicable requirements.

3. RIGHT OF REVISION. The City Council reserves the right to amend this Ordinance to provide for more stringent limitations or requirements on discharges to the wastewater facilities where deemed necessary to comply with the objectives set forth in this Ordinance.

4. DILUTION. No user shall increase the use of potable or process water in any way, nor mix separate waste streams for the purpose of diluting a discharge as a partial or complete substitute for adequate treatment to achieve compliance with the standards set forth in this Ordinance unless approved in writing by the City.

5. SUPPLEMENTARY LIMITATIONS. No user shall discharge wastewater containing concentrations of the following enumerated materials exceeding the following values unless prior approval is granted by the City Council:

<u>Material</u>	<u>Concentration (mg/L)</u>
Biochemical Oxygen Demand	250 mg/L
Chemical Oxygen Demand	750 mg/L
Suspended Solids	250 mg/L
Total Nitrogen	40 mg/L
Ammonia Nitrogen	25 mg/L
Total Phosphorus	7 mg/L
Fats, Oil and Grease (FOG)	100 mg/L

The City Council may also impose mass limitations on users which are using dilution to meet the Pretreatment Standards or requirements of this Ordinance, or in other cases where the imposition of mass limitations is deemed appropriate by the City Council.

C. ACCIDENTAL DISCHARGES. Each user shall provide protection from accidental discharge of prohibited or regulated materials or substances established by this Ordinance. Where necessary, facilities to prevent additional discharge of prohibited materials shall be provided and maintained at the user's cost and expense. Detailed plans showing facilities and operating procedures shall be submitted to the City for review, and shall be approved by the City before construction of the facility. Review and approval of such plans and operating procedures by the City shall not relieve the user from the responsibility to modify its facility as necessary to meet the requirements of this Ordinance.

Dischargers shall notify the City immediately upon the occurrence of a "slug load" or accidental discharge of substances prohibited by this Ordinance. The notification shall include location of discharge, date and time thereof, type of waste, concentration and volume, and corrective actions. Any user who discharges a slug load or prohibited materials shall be liable for any expense, loss or damage to the City's wastewater facilities on wastewater treatment works, in addition to the amount of any forfeitures imposed on the City on account thereof under State or Federal law.

Signs shall be permanently posted in conspicuous places on industrial user's premises, advising employees who to call in the event of a slug or accidental discharge. Employers shall instruct all employees who may cause or discover such a discharge with respect to emergency notification procedures.

D. SPECIAL AGREEMENTS. No statement contained in this article shall be construed as prohibiting any special agreement between the City and any person whereby an industrial waste of unusual strength or character may be admitted to the wastewater treatment works, either before or after pretreatment, provided that there is no impairment of the functioning of the wastewater treatment works by reason of the admission of such wastes, and no extra costs are incurred by the City without recompense by the person, provided that all rates and provisions set forth are complied with. (ORD 440 1993)

13.20.050 SEWER SERVICE CHARGE SYSTEM.

A. ADDITIONAL DEFINITIONS. The following terms shall have the following meaning under this Ordinance:

1. DEBT SERVICE CHARGES shall include all costs associated with repayment of debts incurred for the construction and/or rehabilitation of wastewater collection system and treatment facilities. The Debt Service Charge is also referred to as the Residential Equivalent Unit Charge (REU Charge). (ORD 539, 2003)

2. NORMAL DOMESTIC STRENGTH WASTEWATER shall mean wastewater with concentrations of BODs no greater than 250 milligrams per liter (mg/L), COD no greater than 750 milligrams per liter (mg/L) suspended solids no greater than 250 milligrams per liter (mg/L), total nitrogen no greater than 40 milligrams per liter (mg/L), ammonia nitrogen no greater than 25 milligrams per liter (mg/L) and total phosphorus no greater than 7 milligrams per liter (mg/L).

3. NORMAL USER shall be a user whose contributions to the sewerage system consist only of normal domestic strength wastewater originating from a house, apartment, or other living quarters occupied by a person or persons constituting a distinct household, business or commercial enterprise.

4. OPERATION AND MAINTENANCE (O&M) COSTS shall include all costs associated with the operation and maintenance of the wastewater collection and treatment facilities. These costs, including costs associated with clear water flows (I/I), shall be divided proportionately among the various sewer users.

5. REPLACEMENT COSTS (R) shall include all costs necessary to accumulate the resources to replace equipment as required to maintain capacity and performance during the design life of the facility. A separate, segregated, distinct replacement fund shall be established and used only for replacement of equipment designated by the fund.

6. SEWER SERVICE CHARGE shall include all costs associated with operation and maintenance and replacement costs.

7. SEWER SERVICE CHARGE is the total service charge levied on users of the sewer system for payment of capital expenses, including debt service charges, as well as the operation and maintenance costs, including replacement of said facilities. The Sewer Service Charge is the total of the Debt Service Charges and the Sewer Use Charge.

B. POLICY. It shall be the policy of the City to obtain sufficient revenues to pay the costs for debt service and the operation and maintenance of the wastewater facilities, including a replacement fund, through a system of sewer service charges as defined in this section. The system shall assure that each user of the wastewater facilities pays their proportionate share of the cost of such facilities.

C. BASIS FOR SEWER SERVICE CHARGE. The sewer service charge shall be based on two parts, the Residential Equivalent Unit (REU) plus the Sewer Use Charge. If any person discharging sewage into the public sewer system procures any part or all of his or her water from sources other than the City Water Utility, the person shall furnish, install and maintain at his or her expense water meters of a type approved by the Water Utility for the purpose of determining the volume of sewage discharged to the sewerage system. (Ord 539, 2003)

The Residential Equivalent Unit charge shall be sufficient to pay the Debt Service Charges related to the Utility. The Sewer Use Charge shall be sufficient to pay the costs of operation and maintenance, including any replacement fund, of the wastewater facilities. The City Council has provided the initial estimates of number of users, costs, etc., to calculate the first year's user charges. The rates in this ordinance shall be reviewed not less than biennially. Such review will be performed by the City Council. Rates shall be adjusted, as required, to reflect the actual number and size of users and actual costs. Users shall be notified annually of the portion of service charges attributable to operation, maintenance, replacement and debt service.

The City's share as a customer of the municipal sewer utility may be up to \$60,000.00, in order to allow the City to meet the requirements of previous and recent Bond issues.

D. RESIDENTIAL EQUIVALENT UNIT CHARGE. A Residential Equivalent Unit charge (REU) is hereby imposed upon each lot, parcel of land, building or premises served by the sewerage system or otherwise discharging sewage, including non-domestic and industrial wastes, into the system. (Ord 539, 2003)

The following sewer rates shall be effective January 1, 2023:

	Fixed Charge	Flow Charge
Residential Equivalent Unit (REU) (Ord 100R004; Ord. 549, 2003; Ord. 120R005)	\$18.16	\$5.95 ccf

E. SEWER USE CHARGE. A Sewer Use Charge is hereby imposed on all users of the sewerage system based upon the metered water used thereon or therein as calculated by the Water Utility. On or before October 15 of each year, the City Clerk shall recompute the Sewer Use Charge per 100 cubic feet of water used. This charge shall be computed by dividing the proposed net yearly operation, maintenance and replacement budget as provided in this ordinance by the previous year's average billable water usage. (Ord 539, 2003)

Any refrigeration, air conditioning/humidification system or industrial cooling water not entering the sewerage system shall not be used in computing the Sewer Use Charge if a separate meter is installed. The user of such system shall be responsible for furnishing, installing and maintaining the necessary meter.

Such Sewer Use Charge shall be payable as hereinafter provided and in an amount determinable as follows:

(A) CATEGORY A is defined as normal domestic strength wastewater as defined in subsection A.2. of this section. The sewer service charge for Category A wastewater is a volumetric charge calculated as follows:

$$\text{Sewer Use Charge} = [\text{CF} + 0.00156 (\text{C}_8 + \text{C}_5) + 0.000250 \text{CN} + 0.000043 \text{C}_p] \times \text{V} = \mathbf{Cv \times V}$$

CF= Flow unit price = \$2.32 per 100 cubic feet

Cs = BOD unit price = \$348.41 per 1,000 pounds

Cs= SS unit price = \$426.81 per 1,000 pounds

CN = TN unit price = \$2,095.89 per 1,000 pounds

Cr= TP unit price = \$17,323.02 per 1,000 pounds

V = Total volume of water used during billing periods in units of 100 cubic feet

Cv = Volume unit price = \$5.95 per 100 cubic feet.

(B) CATEGORY B is defined as wastewater having strength greater than normal domestic strength wastewater as defined in subsection A.2. of this section. The minimum Category B charge will be no less than the Category A charge for normal domestic strength wastewater.

1. The equation for the monthly Category B is as follows unless COD in mg/L is three times greater than BOD in mg/L:

Sewer Use Charge = Category A charge +

$$\frac{\text{BOD} \times \text{V} \times 0.00834 \times \text{C}_8}{\text{C}_5 \times 1000} + \frac{\text{SS} \times \text{V} \times 0.00834}{1000} +$$

$$\frac{\text{TN} \times \text{V} \times 0.00834 \times \text{CN}}{1000} + \frac{\text{TP} \times \text{V} \times 0.00834 \times \text{C}_p}{1000}$$

Where:

BOD = Total biochemical oxygen demand expressed in mg/L less 250 mg/L

Cs = BOD unit price = \$348.41 per 1,000 pounds

SS = Total suspended solids expressed in mg/L less 250 mg/L

Cs= SS unit price = \$426.81 per 1,000 pounds

TN = Total nitrogen expressed in mg/L less 40 mg/L

CN = TN unit price = \$2,095.89 per 1,000 pounds

TP = Total phosphorus expressed in mg/L less 7 mg/L

Cp = TP unit price = \$17,323.02 per 1,000 pounds

V = Total volume of water used during billing period in units of 1,000 gallons.

2. If the COD in mg/L is three times greater than BOD in mg/L the modified equation for the monthly Category Bis as follows:

Sewer Use Charge = Category A charge +

$$\begin{aligned} & \text{COD} \times V \times \frac{0.00834 \times C_c}{1000} + \frac{\text{SS} \times V \times C_s}{1000} + \\ & \frac{\text{TN} \times V \times 0.00834 \times C_N}{1000} + \frac{\text{TP} \times V \times 0.00834 \times C_p}{1000} \end{aligned}$$

Where:

All definitions in subsection 1 apply and

COD = Total chemical oxygen demand expressed in mg/L less 750 mg/L

Cc= COD unit price = \$116.14 per 1,000 pounds.

(C) CATEGORY C is defined as having strength greater than normal domestic strength wastewater as defined in subsection A.2. of this section. The equation for the charge is the same as Category B with an additional debt service and administrative charge of \$24.43 per load. It will be assumed that holding tank wastewater had a BOD of 600 mg/L, SS of 1,800 mg/L, TN of 150 mg/L and TP of 30 mg/L septic tank wastewater has a BOD of 5,000 mg/L, SS of 15,000 mg/L, TN of 1000 mg/L and TP of 200 mg/L unless an actual analysis is furnished by the discharger.

(D) CATEGORY D is defined as leachate from the Vernon County Landfill. The equation for the charge is the same as Category B with an additional debt service and administrative charge of \$34.36 per load. The BOD and SS concentrations shall be based on the average of weekly lab analysis of the leachate, with a minimum strength of 250 mg/L BOD or 750 mg/L COD whichever is greater, 250 mg/L suspended solids, 40 mg/L total nitrogen, and 7 mg/L total phosphorus. This rate is based on leachate delivered to the wastewater treatment facility. (Ord. 07OR002; Ord. 12OR005)

13.20.060 Control of industrial and septage wastewaters.

A. DICHARGE CONDITIONS. If any wastewaters or septage are discharged, or proposed to be discharged, to the wastewater facilities which contain substances or possess the characteristics enumerated in Article V and which, in the judgment of the City Council may be detrimental to the wastewater facilities, the City Council may:

1. Reject the wastes.
2. Require pretreatment to an acceptable condition for discharge to the sewer system.
3. Require control over the quantities and rates of discharge.
4. Require payment to cover the added cost of handling and treating the wastewater not covered by existing sewer charges under the provisions of this ordinance.

B. SEPTAGE DISCHARGES. Septage discharged to the wastewater facilities shall be of domestic origin only and septic tank wastes shall be segregated from holding tank wastes.

C. CONTROL MANHOLES.

1. Each person discharging industrial wastes into a public sewer shall construct and maintain one or more control manholes or access points to facilitate observation, measurement, and sampling their waste, excluding domestic sewage when feasible.

2. Control manholes or access facilities shall be located and built in a manner acceptable to the City Council. If measuring devices are to be permanently installed, they shall be of a type acceptable to the City Council.

3. Control manholes, access facilities, and related equipment shall be installed by the person discharging the industrial waste, at their expense, and shall be maintained by the person discharging the waste so as to be in safe condition, accessible, and in proper operating condition at all times. Plans for installation of the control manholes or access facilities and related equipment shall be approved by the City Council prior to the beginning of construction.

D. MEASUREMENT OF FLOW. The volume of flow used for computing the Sewer Use Charge shall be based upon the water consumption of the person as shown in the records of meter readings maintained by the City Water Utility unless approved wastewater flow meters are provided. Septage, holding tank and leachate volumes shall be determined by truck volume measurement upon receipt at the wastewater treatment plant.

E. PROVISION FOR DEDUCTIONS. In the event that a person discharging industrial waste into the public sewers produces evidence satisfactory to the City Council that more than 10 percent of the total annual volume of water used for all purposes does not reach the public sewer, then the determination of the water consumption to be used in computing the wastewater volume discharged into the public sewer may be made a matter of agreement between the City and the industrial wastewater discharger.

F. METERING OF WASTEWATER. Devices for measuring the volume of wastewater discharged may be required by the City Council if this volume cannot otherwise be determined from the metered water consumption records. Metering devices for determining the volume of wastewater shall be installed, owned, and maintained by the person discharging the wastewater. Following approval and installation, such meters may not be removed without the consent of the City Council.

G. WASTEWATER SAMPLING.

1. Industrial wastes and septage discharged into the public sewers shall be subject to periodic inspection and a determination of character and concentration of said waste as specified by the City. Septage, holding tank and leachate wastewaters shall be sampled and analyzed on the schedule specified by the City.

2. Samples shall be collected in such a manner as to be representative of the composition of the wastes. The sampling may be accomplished either manually or by the use of mechanical equipment acceptable to the City.

3. Laboratory analysis shall be the responsibility of the person discharging the wastewater, septage or leachate and shall be subject to the approval of the City Council or its duly authorized representatives. Every care shall be exercised in the collection of samples to ensure their preservation in a state comparable to that at the time the sample was taken. All analysis shall be performed by a Wisconsin certified laboratory.

H. PRETREATMENT. When required, in the opinion of the City Council, to modify or eliminate wastes that are harmful to the structures, processes, or operation of the wastewater facilities, the discharger shall provide at their expense such preliminary treatment or processing facilities as may be required to render this waste acceptable for admission to the public sewers. Septage, holding tank and leachate wastewaters shall only be received at the designated facilities at the wastewater treatment plant.

I. GREASE AND/OR SAND INTERCEPTORS. When required, in the opinion of the City Council, grease, oil, and sand interceptors shall be provided by the discharger and shall be located as to be readily and easily accessible for cleaning and inspection. In the maintaining of these interceptors, the discharger shall be responsible for the proper removal and disposal by appropriate means of the captured material and shall maintain records of the dates and means of disposal which are subject to review by the city. Any removal and hauling of the collected materials not performed by the discharger's personnel must be performed by currently licensed disposal firms.

J. ANALYSES.

1. All measurements, tests, and analyses of the characteristics of water, wastewater, septage and leachate to which reference is made in the Ordinances shall be determined in accordance with the latest edition of "Standard Methods". Sampling methods, locations, times, durations, and frequencies are to be determined on an individual basis subject to approval by the City Engineer.

2. Determination of the character and concentration of the industrial wastewater shall be made by the person discharging them or their agent, as designated and required by the City Council. The City may also make its own analyses of the wastes and these determinations shall be used as a basis for charges. If the person discharging the waste contests the determination, the City may elect to have an independent laboratory determine the character and concentration of the waste. Said independent laboratory shall be certified under NR 149 and be acceptable to both the City and the person discharging the waste. All costs incurred by the independent laboratory in making the determination shall be assumed by the discharger.

K. SUBMISSION OF INFORMATION. Plans, specifications, and any other pertinent information relating to proposed flow equalization, pretreatment, of wastewater processing facilities shall be submitted for review to the City Engineer prior to the start of their construction if the effluent from such facilities is to be discharged into the public sewers.

L. SUBMISSION OF BASIC DATA. Within three (3) months after notice by the City Council, each person who discharges industrial wastes to a public sewer shall prepare and file with the City, a report that shall include pertinent data relating to the quantity and characteristics of the waste discharged to the sewerage system. The City shall be notified 60 days in advance of any plans that change the discharge by more than 15 percent of flow or strength. Such a request shall be evaluated as provided in this ordinance.

Similarly, each person desiring to make a new connection to a public sewer for the purpose of discharging industrial wastes shall prepare and file with the City a report that shall include actual or predicted data relating to the quantity and characteristics of the waste to be discharged.(ORD 440 1993)

13.20.070 Payment for Charges.

A. PAYMENT AND PENALTY. The sewer service and usage charges shall be for the corresponding period of the water service and usage charges and shall be payable to the City Clerk not later than 20 days after the invoice has been posted. A sewer penalty charge consistent with the water penalty charge on the current water rate case shall be added to all bills not paid by the date fixed for final payment.

B. CHARGES A LIEN. All sewage charges shall be a lien upon the property serviced, pursuant to section 66.0821, Wisconsin Statutes, and shall be collected in the manner provided therein. (Ord. 539, 2003)

C. DISPOSITION OF REVENUE. The amounts received from the collection of charges authorized by this Ordinance shall be credited to a wastewater facilities account which shall show all receipts and expenditures of the wastewater facilities. Charges collected for replacement expenses shall be credited to a segregated, nonlapsing replacement account. These funds are to be used exclusively for replacement. When appropriated by the City Council, the credits to the wastewater facilities account shall be available for the payment of costs of wastewater facilities consistent with NR 162. All present outstanding sewer system general obligation bonds, including refunding bonds, shall be paid from this fund as to both principal and interest.

D. EXCESS REVENUES. Any surplus remaining after payment of debt service charges, operation and maintenance and replacement costs shall be credited to the following year's operation and maintenance account. Excess revenues collected from a user class will be applied to operation and maintenance costs attributable to that class for the next year.

13.20.080 Audit. ANNUAL AUDIT. The City Council shall have conducted an independent Annual Audit, the purpose of which shall be to maintain the proportionality between users and user classes of the sewer user charge system and to ensure that adequate revenues are available relative to increasing operation, maintenance and replacement costs and debt service charges. The findings and recommendations of this audit shall be available for public inspection.

13.20.090 Violations and Penalties.

A. DAMAGES. No unauthorized person shall maliciously, willfully, or negligently break, damage, destroy, uncover, deface, or tamper with any structure or equipment which is a part of the wastewater facilities. Any person violating this provision shall be subject to immediate arrest under charge of disorderly conduct.

B. WRITTEN NOTICE OF VIOLATION. Any person connected to the wastewater facilities found to be violating a provision of this Ordinance shall be served by the City with a written notice stating the nature of the violation and providing a reasonable time for the satisfactory correction thereof. The offender shall, within the period of time stated in such notice, permanently cease all violations.

Any licensed disposer discharging to the wastewater facilities found to be violating a provision of this ordinance or of any conditions of the City's approval for septage disposal, may have their approval immediately revoked. This revocation shall be done in writing and state the reasons for revoking the septage disposal approval.

C. DELETERIOUS DISCHARGE. Any person found to be responsible for accidentally allowing a deleterious discharge into the wastewater facilities which causes damage to the facilities and/or receiving water body shall, in addition to a forfeiture, pay the amount to cover all damages, both of which will be established by the City Council.

D. DISCHARGE REPORTING. Any person responsible for a discharge that may have a detrimental impact on the sewerage system shall immediately report the nature and amount of the discharge to the Utilities Office.

E. CONTINUED VIOLATIONS. Any person, partnership, or corporation, or any officer, agent, or employee thereof, who shall continue any violation beyond the aforesaid notice time limit provided shall, upon conviction thereof, forfeit not less than five hundred dollars (\$500.00), together with the costs of prosecution. In default of payment of such forfeiture and costs, said violator shall be imprisoned in the County Jail for a period not to exceed five (5) days. Each day in which any violation is continued beyond the aforesaid notice time limit shall be deemed a separate offense.

F. LIABILITY TO CITY FOR LOSSES. Any person violating any provision of this Ordinance shall become liable to the City for any expense, loss, or damage occasioned by reason of such violation which the City may suffer as a result thereof.

G. DAMAGE RECOVERY. The City shall have the right of recovery from all persons, any expense incurred by said system for the repair or replacement of any part of the wastewater facilities damaged in any manner by any person by the performance of any work under their control, or by any negligent acts.

H. PENALTIES. Any person who shall violate any of the provisions of this Ordinance or rules or regulations of the City or who shall connect a service pipe or discharge without first having obtained a permit therefore; or who shall violate any provisions of the Wisconsin Statutes, Wisconsin Administrative Code, or any other materials which are incorporated by reference, shall upon conviction thereof forfeit not less than \$50.00 nor more than \$500.00 and the costs of prosecution. This, however, shall not bar the City from enforcing the connection duties set out in this ordinance for mandatory hookup.

I. APPEAL PROCEDURES. Any user, affected by any decision, action, or determination, including cease and desist orders, made by the interpreting or implementing provisions of this Ordinance may file with the City Council a written request for reconsideration within ten (10) days of the date of such decision, action, or determination, setting forth in detail the facts supporting the user's request for reconsideration. The City Council shall render a decision on the request for reconsideration to the user in writing within fifteen (15) days of receipt of request.

13.20.100 Repeal and validity.

A. REPEAL OF CONFLICTING ORDINANCES. All ordinances, resolution, orders or parts thereof heretofore adopted, enacted or entered in conflict with this Ordinance shall be and the same are hereby repealed.

B. SAVINGS CLAUSE. If any provision of this Ordinance is found invalid or unconstitutional or if in the application of this Ordinance to any person or circumstances is found to be invalid or unconstitutional, such invalidity or unconstitutionality shall not affect the other provisions or application of this Ordinance which can be given effect without the invalid or unconstitutional provision or application.

C. AMENDMENTS. The City, through its duly qualified governing body, may amend this Ordinance in part or in whole whenever it may deem necessary. (ORD 440 1993)

Chapter 13.30CROSS CONNECTION CONTROLSections:

13.30.010	General Policy; Purpose
13.30.020	Definitions
13.30.030	Cross connections prohibited
13.30.040	Responsibility of City
13.30.050	Responsibility of Owner
13.30.060	Inspections
13.30.070	Right of Entry
13.30.080	Authority to Discontinue Service
13.30.090	Reconnection of Service
13.30.100	Emergency Discontinuance of Service
13.30.110	Additional Protection
13.30.120	Public Water Supply
13.30.130	Plumbing Code

Section 13.30.010. General Policy; Purpose: The purpose of this ordinance is:

To protect the health and welfare of users of the public potable water supply of City of Viroqua from the possibility of contamination or pollution of the potable water system(s) under the direct authority of the City of Viroqua Public Water Utility. (Ord 13OR001)

To provide for the control and/or elimination of existing cross connections (actual or potential) between the customer's potable water system(s) and other environment(s) containing substance(s) which may contaminate or pollute the water supply.

To provide for the maintenance of a continuing Comprehensive Program of Cross Connection Control which will systematically and effectively prevent the contamination or pollution of all potable water system(s) under the direct authority of the City of Viroqua Public Water Utility.

Section 13.30.020 Definitions:

Backflow: The undesirable flow of water or mixtures of water and other liquids, solids gases or other substances under positive or reduced pressure into the City of Viroqua Water Utility potable supply of water from any source.

Backflow Prevention: A means designed to prevent backflow caused by backpressure or backsiphonage; most commonly categorized as air gap, reduced pressure principle backflow assembly, double check valve assembly, pressure vacuum breaker assembly, backsiphonage backflow vacuum breaker (spill resistant pressure vacuum breaker) assembly, pipe applied atmospheric vacuum breaker, flush tank ballcock, laboratory faucet backflow preventer, backflow preventer for carbonated beverage machine, vacuum breaker wall hydrants, (freeze resistant automatic draining type), chemical dispensing machine, hose connection vacuum breaker, hose connection backflow preventer, backflow preventer with intermediate atmospheric vent and barometric loop.

Backpressure: An elevation of pressure in the downstream piping system (i.e. Pump, elevation of piping, or steam and/or air pressure) above the utility supply pressure, which would cause or tend a reversal of the normal direction of flow.

Backsiphonage: The flow of water or other liquids, mixtures or substances into the utility's potable water system from any source caused by the sudden reduction of pressure in the utility's potable water supply system.

Cross Connection: Any physical connection or arrangement between two otherwise separate systems, one of which contains potable water from the utility, and the other containing water from a private source, water of unknown or questionable safety, or steam, gases or chemicals, whereby there may be a flow from one system to the other, the direction of flow depending on the pressure differential between the two systems.

Cross Connection Control Manual: Policies and procedures for cross connection control and backflow prevention for the City of Viroqua.

Section 13.30.030 Cross Connection Prohibited: No person shall establish or permit to be established or maintain or permit to be maintained any cross connection. No interconnection shall be established whereby potable water from a private, auxiliary or emergency water supply, other than the public water supply of the utility, unless such private, auxiliary or emergency water supply and the method of connection and use of such supply have been approved by the utility and the Wisconsin Department of Natural Resources.

Section 13.30.040 Responsibility: The City of Viroqua Public Water Utility shall be responsible for the protection of the public potable water distribution system from contamination or pollution due to backflow of contaminants or pollutants. The utility shall charge fees according to the utility's "*Cross Connection Control Manual*" for maintaining a Comprehensive Cross Connection Control Protection Plan.

Section 13.30.050 Owner Responsibility: The property owner shall be responsible for the protection of the customer's potable water system. The responsibilities include the elimination of or protection from all cross connections on their premises. The owner shall, at their own expense, install, maintain and test any and all backflow preventers on their premises in compliance with the Department of Safety and Professional Services SPS 382.21 requirements and the utility's *"Cross Connection Control Manual"*. The property shall have corrected any malfunction revealed by periodic testing of any backflow preventer on their premises. The property owner shall inform the utility of any proposed or modified cross connections and also any existing cross connections that are not protected by an approved backflow prevention means. The property owner shall not install a by-pass around any backflow preventer unless there is a backflow preventer of the same type in the by-pass. Property owners who cannot shut down operation for testing of the backflow prevention assembly must supply additional assemblies necessary to allow testing and maintenance to take place. In the event the property owner installs potable water using fixtures, equipment or appurtenances upstream of a backflow preventer, such must have its own approved backflow prevention means. The property owner is required to follow the protection practices described in the American Water Works Association publication AWWA M-14 titled *"Recommended Backflow Prevention and Cross Connection Control"*, United States Environmental Protection Agency publication titled *"Cross Connection Control Manual"*, Wisconsin Department of Safety and Professional Services Plumbing Code, SPS 381-384 and the utility's *"Cross Connection Control Manual"*, unless the utility requires or authorizes other means of protecting the potable water supply system. These requirements or authorizations will be at the discretion of the utility.

Section 13.30.060 Inspections: It shall be the duty of the utility to cause surveys to be made of all properties serviced by the utility where cross connections with the public water system is deemed possible.

A. Residential properties serviced by the utility shall be surveyed on a 10-year interval. The utility may, but is not required to, perform the cross connection survey of the customer's property. (O8OR013)

B. All non-residential properties serviced by the utility shall be surveyed on an interval not exceeding 5 years, and if possible every 2 years. The utility may, but is not required to, perform the cross connection control survey of the customer's property. (O8OR013)

C. If, in the opinion of the utility, the utility is not able to perform the survey, the property owner must, at his or her own expense, have the water piping system surveyed for cross connections by a person who has been properly trained in accordance with the American Society of Sanitary Engineers (ASSE) Standard number 5120 as a Cross Connection Control Surveyor or as otherwise qualified by the Department of Natural Resources or other agency of the State of Wisconsin. The frequency of required survey and resurveys, based upon the potential health hazards, may be shortened by the utility. (O8OR013)

February 2013 revision

Section 13.30.070 Right of Entry: Upon presentation of credentials, representatives of the utility shall have the right to request entry at any reasonable time to examine property served by a connection to the public potable water system of the utility for cross connections. If entry is refused, such representatives shall obtain a special inspection warrant under s.66.122, Wisconsin Statutes. The utility shall charge the property owner a fee of \$50.00 per day for refusal to allow entry to examine any property. Upon request, the owner, lessee or occupant of any property served shall furnish to the inspection agency any pertinent information regarding the piping system on such property.

Section 13.30.080 Authority to Discontinue Service: The utility is hereby authorized and directed to discontinue water service to any property wherein any connection in violation of this section exists and to take such other precautionary measures deemed necessary to eliminate any damage or contamination of the potable water system. Water service shall be discontinued if the means of backflow prevention required by the utility is not installed, tested; maintained and/or repaired in compliance with this ordinance, the Department of Safety and Professional Services Plumbing Code SPS 381-384 and the utility's "*Cross Connection Control Manual*", or if it is found that the means of backflow prevention required by this ordinance has been removed or bypassed. Water service shall be discontinued only after reasonable notice and opportunity for hearing under Chapter 68, Wisconsin Statutes, except as provided in Section 13.30.100.

Section 13.30.090 Reconnection of Service: Water service to any property disconnected under provisions of this ordinance shall not be restored until the cross connection(s) has been eliminated or a backflow prevention means approved by the utility has been installed in compliance with the provisions of this section.

Section 13.30.100 Emergency Discontinuance of Service: If it is determined by the utility that a cross connection or an emergency endangers public health safety or welfare and requires immediate action, service may be immediately discontinued. The owner, lessee or occupant shall have an opportunity for hearing under Chapter 68, Wisconsin Statutes within 10 days of such emergency discontinuance. Such hearing shall be before the City of Viroqua Water (Committee/Board/Commission) and shall conform to all existing due process requirements.

Section 13.30.110 Additional Protection: In the case of premises having (a) cross connections that cannot be permanently corrected or controlled, or (b) intricate plumbing and piping arrangements or where entry to all portions of the premises is not readily accessible for surveying purposes, making it impractical or impossible to ascertain whether or not dangerous cross connections exist, the public water supply system shall be protected in the service line. In the case of any premises where there is any material dangerous to health that is handled in

February 2013 revision

such a manner that, in the opinion of the utility, could create an actual or potential hazard to the public water supply system, an approved air gap separation or an approved reduced pressure principle backflow assembly shall protect the public water supply system. Examples of premises where these conditions will exist include premises with auxiliary water supplies either interconnected or not interconnected with the public water supply system, premises where inspection is restricted, hospitals, mortuaries, clinics, laboratories, piers, docks, and other water front facilities, sewage treatment plants, sewage lift stations, food and beverage, processing plants, chemical plants using a water process, metal processing plants or nuclear reactors, car washing facilities and premises with reclaimed water systems. In the case of any presence of toxic substances, the utility may require an approved air gap or reduced pressure principal backflow assembly at the service connection to protect the public water supply system. This requirement will be at the discretion of the utility.

Section 13.30.120 Public Water Supplies: This section does not supercede the State of Wisconsin Department of Natural Resources Administrative Code NR811, but is supplementary to it.

Section 13.30.130 Plumbing Code. The City of Viroqua adopts by reference the Wisconsin Uniform Plumbing Code being Chapter SPS 381-384, Wisconsin Administrative Code. This section does not supercede the Wisconsin Uniform Plumbing Code or the City of Viroqua Plumbing Code but is supplementary to it. (Ord 03OR001; Ord 07OR005)

Chapter 13.32

PRIVATE WELLS

Sections:

- 13.32.010 Closing wells; permits.
- 13.32.020 Well operation permit.
- 13.32.030 Abandoned wells.
- 13.32.040 Report of abandoned wells.
- 13.32.050 Penalty.

13.32.010 Closing wells; permits. All private wells located on any premises which is served by the public water systems of the City of Viroqua shall be properly filled by July 1, 1989. Only those wells for which a well operation permit has been granted by the City of Viroqua may be exempted from this requirement during such period as such wells are maintained and operated in a manner which prevents contaminated surface or near-surface waters or other materials from reaching usable ground water. (Ord. 407, 1989).

13.32.020 Well operation permit. A well operation permit shall be granted to the owner of a well to operate a well for a period not to exceed five years, if the following conditions are met, which permit shall be issued by the Clerk and may be renewed so long as such conditions continue to be met:

A. The well and pump installation meet the requirements of the Department of Natural Resources, currently found in Chapter NR 812, Wisconsin Administrative Code, and a well constructor's report is on file with the Department of Natural Resources, or certification of the acceptability of the well has been granted by the Private Water Supply Section of the Department of Natural Resources. The permit shall require, but not be limited to, requiring that bacteriological sampling, consisting of obtaining a minimum of two safe samples to be taken two weeks apart prior to issuing or reissuing the permit to establish that the water is safe. (Ord 08OR012)

B. The well has a history of producing safe water and presently produces bacteriologically safe water as evidenced by two safe samples to be taken two weeks apart. (Ord 08OR012)

C. The proposed use of the well can be justified as being necessary in addition to water provided by the public water system.

D. No physical connection shall exist between the piping of the public water system and the private well. (Ord. 407, 1989).

13.32.030 Abandoned wells. All wells abandoned shall be filled according to the requirements of the Department of Natural Resources, currently found in Chapter NR 812, Wisconsin Administrative Code. The pump and piping must be removed and the well checked for obstructions prior to plugging. Any obstruction or liner must be removed. (Ord 08OR012; Ord. 407, 1989).

13.32.040 Report of abandoned wells. A well abandonment report must be submitted by the well owner to the Department of Natural Resources on forms provided by that Department. The report shall be submitted immediately upon completion of the filling of the well. The filling must be observed by a representative of the City of Viroqua. (Ord. 407, 1989).

13.32.050 Penalty. Any person who violates any provision of this ordinance shall be required to forfeit not less than \$50 nor more than \$200, together with the cost of prosecution, and upon default in payment of such forfeiture and costs shall be imprisoned in the county jail until such forfeiture and costs are paid, not exceeding 30 days. Each day a violation continues constitutes a separate offense, and constitutes a public nuisance which the City may enjoin and abate. (Ord. 407, 1989).

Chapter 13.34WELLHEAD PROTECTIONSections:

13.34.010	Purpose and Authority
13.34.020	Application of Regulations
13.34.030	Definitions
13.34.040	Groundwater Protection Overlay District
13.34.050	Supremacy of this District
13.34.060	Zones
13.34.070	Groundwater Protection Overlay District Boundaries
13.34.080	Permitted Uses
13.34.090	Separation Distance Requirements
13.34.100	Prohibited Uses
13.34.110	Classification of Use
13.34.120	Provisional Use Permits
13.34.130	Design and Operational Standards
13.34.140	Requirement for Existing Facilities
13.34.150	Changing Technology
13.34.160	Enforcement and Penalty
13.34.170	Conflict, Interpretation and Severability.

13.34.010. Purpose and Authority.

A PURPOSE. The residents of the City of Viroqua depend exclusively on groundwater for a safe drinking water supply. Certain land use practices and activities can seriously threaten or degrade groundwater quality. The purpose of this Wellhead Protection Ordinance is to institute land use regulations and restrictions protecting the municipal water supply of the City of Viroqua and to promote the public health, safety and general welfare of the City of Viroqua's residents. (14OR001)

B AUTHORITY. Statutory authority of the City of Viroqua to enact these regulations was established by the Wisconsin Legislature in 1983, Wisconsin Act 410 (effective May 11, 1984), which specifically added groundwater protection, in s. 59.97(1) and s. 62.23(7)(c), Wis. Stats., to the statutory authorization for county and municipal planning and zoning to protect the public health, safety and welfare. In Addition, under s. 62.23(7)(c), Wis. Stats., the City of Viroqua has the authority to enact this ordinance, effective in the incorporated areas of the City of Viroqua, to encourage the protection of groundwater resources.

13.34.020 Application of Regulations. The regulations specified in this Wellhead Protection Ordinance shall apply to the incorporated areas of the City of Viroqua that lie within the recharge areas for municipal water supply wells as defined in Section 13.34.030, and are in addition to the requirements in the underlying zoning district, if any. If there is a conflict between this ordinance and the zoning ordinance, the more restrictive provision shall apply.

13.34.030 Definitions.

Aquifer. A saturated, permeable geologic formation that contains and will yield significant quantities of water.

Provisional Use. Land use or development that either by design or operation requires additional technical or regulatory review and permitting in order to exist within defined areas of a wellhead protection district.

Cone of Depression. The area around a well, in which the water level has been lowered at least one-tenth of a foot by pumping of the well.

Design Standards. Regulations that apply to the development of structures and infrastructure within a designated wellhead protection district.

Five-year Time of Travel. The 5-year time of travel is the recharge area upgradient of the cone of depression, the outer boundary from which it is determined or estimated that groundwater will take five years to reach a pumping well.

Municipal Water Supply. The municipal water supply of the City of Viroqua.

Operating Standards. Regulations that apply to land use activities/business practices within a designated wellhead protection district.

Permitted Use. Land use or development that by design or operation is allowed without further technical or regulatory review within defined areas of a wellhead protection district.

Person. Person means an individual, partnership, association, corporation, municipality or state agency, or other legal entity.

Recharge area. The area which encompasses all areas or features that, by surface infiltration of water that reaches the zone of saturation of an aquifer, supplies groundwater to a well.

Regulated Substances. Chemicals and chemical mixtures that are health hazards except for product registered under the Federal Insecticide, Fungicide and Rodenticide Act (FIFRA). Health hazards for chemicals and chemical mixtures are typically identified on Material Safety Data Sheets (MSDS) available from the substance manufacturer or supplier. Substances packaged for consumption for humans or animals are not considered Regulated Substances. Regulated Substances include:

Chemicals for which there is scientific evidence that acute or chronic health effects may result from exposure including carcinogens, toxic and highly toxic agents, irritants, corrosives, sensitizers, hepatotoxins, agents that act on the hematopoietic system, reproductive toxins, and agents which damage the lungs, skin, eyes, or mucous membranes as defined in 29 Code of Federal Regulations (CFR) 1910.1200, Appendix A, "Health Hazard Definitions (Mandatory)."

Mixtures of chemicals which have been tested as a whole and have been determined to be a health hazard.

Mixtures of chemicals which have not been tested as a whole but which contain any chemical which has been determined to be a health hazard and comprises one (1.0) percent or greater of the composition on a weight per unit weight basis.

Mixtures of chemicals which include a carcinogen if the concentration of the carcinogen in the mixture is one tenth of one (0.1) percent or greater of the composition on a weight per unit weight basis.

Ingredients of mixtures prepared within the Groundwater Protection Overlay District in cases where such ingredients are health hazards but comprise more than one tenth of one (0.1) percent of the mixture on a weight per unit weight basis if carcinogenic, or more than one (1.0) percent of the mixture on a weight per unit weight basis if non-carcinogenic.

Petroleum and non-solid petroleum derivatives (except non-PCB dielectric fluids used in equipment or for transmission of electric power to homes and businesses).

Thirty-day Time of Travel. The 30-day time of travel is the recharge area upgradient of a well, or its cone of depression, the outer boundary of which it is determined or estimated that groundwater will take thirty days to reach a pumping well.

Twenty Five-year Time of Travel. The 25-year time of travel is the recharge area upgradient of the cone of depression, the outer boundary from which it is determined or estimated that groundwater will take twenty five years to reach a pumping well.

Well field. A piece of land used primarily for the purpose of locating wells to supply a municipal water system.

Zone of saturation. The saturated zone is the area of unconsolidated, fractured or porous material that is saturated with water and constitutes groundwater.

13.34.040 Groundwater Protection Overlay District. A Groundwater Protection Overlay District may be created to institute land use regulations and restrictions within a defined area which contributes water directly to a municipal water supply and thus promotes public health, safety, and welfare. The district is intended to protect the groundwater recharge area for the existing or future municipal water supply from contamination.

13.34.050 Supremacy of this District. The regulations of an overlay district will apply in addition to all other regulations that occupy the same geographic area. The provisions of any zoning districts that underlay this overlay district will apply except when provisions of the Groundwater Protection Overlay District are more stringent.

13.34.060 Zones. The Groundwater Protection Overlay District is divided into Zone 1 and Zone 2 as follows:

ZONE 1 OF GROUNDWATER PROTECTION OVERLAY DISTRICT. Zone 1 is the area of land which contributes water to the well in question, out to a 30-day time of travel to the well. Time of travel delineations must be based on accepted hydrogeological research as outlined in the State of Wisconsin Wellhead Protection Program Plan for Public Water Systems with zone boundaries normalized to road centerlines where possible.

ZONE 2 OF THE GROUNDWATER PROTECTION OVERLAY DISTRICT.

For Wells 3 and 4 (Upper Aquifer withdrawals) – Zone 2 encompasses the area of land which contributes water to the well starting at the line which delineates the 30-day time of travel and ends at the line delineating the 5-year time of travel to the well. Time of travel delineations must be based on accepted hydrogeological research as outlined in the State of Wisconsin Wellhead Protection Program Plan for Public Water Systems with zone boundaries normalized to road centerlines and city corporate limits where possible.

For Wells 5 and 6 (Deep Aquifer withdrawals) – Zone 2 encompasses the area of land which contributes water to the well starting at the line which delineates the 30-day time of travel and ends at the line delineating the 25-year time of travel to the well. Time of travel delineations must be based on accepted hydrogeological research as outlined in the State of Wisconsin Wellhead Protection Program Plan for Public Water Systems with zone boundaries normalized to road centerlines and city corporate limits where possible.

13.34.070 Groundwater Protection Overlay District Boundaries.

The boundaries of the Groundwater Protection Overlay Districts shall be shown on the City of Viroqua Zoning Map. The locations and boundaries of the zoning districts established by this ordinance are set forth on Figure 1 "City of Viroqua - Groundwater Protection Overlay District Boundaries – Zones 1 and 2", Figure 2A "City of Viroqua – Groundwater Protection Overlay District Boundary Well 3", Figure 2B "City of Viroqua – Groundwater Protection Overlay District Boundary Well 4", Figure 2C "City of Viroqua – Groundwater Protection Overlay District Boundary Well 5", incorporated herein and hereby made a part of this ordinance. Said figure, together with everything shown thereon and all amendments thereto, shall be as much a part of this ordinance as though fully set forth and described herein.

The wellhead protection zones for Well 3 are delineated on Figure 1 and 2A, and described as follows:

Zone 1. Area enclosed by road centerlines by Oak Street from Main Street to Rock Avenue, Rock Avenue from Oak Street to West South Street, West South Street from Rock Avenue to Main Street, and Main Street from West South Street to Oak Street.

Zone 2. Area enclosed by road centerlines by East South Street from STH "56/82" to East Avenue, East Avenue and its extension from East South Street to Lewison Lane, Lewison Lane and its extension from the aforementioned point to the intersection of South Rusk Avenue and East Maple Street, East Maple Street from South Rusk Avenue to South Main Street, West Maple Street from South Main Street to a point 975 feet west of the intersection of West Maple Street and Garfield Avenue, thence from the aforementioned point north to the intersection of Western Avenue and Independence Street, Independence Street from Western Avenue to Chicago Avenue, Chicago Avenue from Independence Street to West Broadway, West Broadway from Chicago Avenue to Bekkedal Court, Bekkedal Court and its extension from West Broadway a point on Noggle Lane 190 feet north of the intersection of Noggle Lane and Chase Street, thence east from the aforementioned point to the intersection of North Main Street and Fairview Drive, Fairview Drive from North Main Street to North East Avenue, North East Avenue from Fairview Drive to East Broadway, East Broadway and its extension from North East Avenue east to a point on Fifth Avenue extended north, thence south from the aforementioned point to the intersection of Fifth Avenue and East Decker Street (STH "56/82"), East Decker Street (STH "56/82") from Fifth Avenue to East South Street.

The wellhead protection zones for Well 4 are delineated on Figure 1 and 2B, and described as follows:

1. Zone 1. Area enclosed by road centerlines by West Decker Street from Western Avenue to Hillyer Avenue, Hillyer Avenue from West Decker Street to Independence Street, Independence Street from Hillyer Avenue to Western Avenue, and Western Avenue from Independence Street to West Decker Street.

Zone 2. Area enclosed by road centerlines by West Jefferson Street and its extension West from Rock Avenue to Parkwood Trail, Parkwood Trail from West Jefferson Street extended West to Johnson Street, Johnson Street from Parkwood Trail to Education Avenue, Education Avenue and its extension from Johnson Street to the north line of Section 31, T.13 N,-R.4 W., thence east along the north line of Section 31, T.13 N,-R.4 W. to a point 290 feet west of USH "14/61", thence north 190 feet, thence east 290 feet to USH "14/61", USH "14/61", from the aforementioned point to Fairgrounds Road, Fairgrounds Road from USH "14/61" to Nelson Parkway, Nelson Parkway from Fairgrounds Road to Fairview Drive where the road name changes to North East Avenue, North East Avenue from Fairview Drive to Church Street, Church Street from North East Avenue to Washington Street, Washington Street from Church Street to Gillette Street, Gillette Street from Washington Street to North Rusk Avenue, North Rusk Avenue from Gillette Street to East Decker Street, East Decker Street from North Rusk Avenue to North Main Street, North Main Street from East Decker Street to Court Street, Court Street from East Main Street to North Rock Avenue, North Rock Avenue from Court Street to West Jefferson Avenue.

The wellhead protection zones for Well 5 are delineated on Figure 1 and 2C, and described as follows:

1. Zone 1. Area enclosed by a 80 foot radius around Well 5.

Zone 2. The area described as follows using public land survey lines all within Township 13N, Range 4W: Commencing from the southwest corner of the SE $\frac{1}{4}$ of section 29, then east to the southeast corner of the SE $\frac{1}{4}$ of the SE $\frac{1}{4}$ of section 29, then south to the point 764 ft south of the south east corner of the NE $\frac{1}{4}$ of the NE $\frac{1}{4}$ of section 34, then west to the southwest corner of the NE $\frac{1}{4}$ of the NW $\frac{1}{4}$ of section 32, then north to the northwest corner of the SE $\frac{1}{4}$ of the SW $\frac{1}{4}$ of section 29, then east to the northeast corner of the SE $\frac{1}{4}$ of the SW $\frac{1}{4}$ of section 29, and then south to the point of origin.

The wellhead protection zones for Well 6 are delineated on Figure 1 and 2D, and described as follows:

1. Zone 1. Area enclosed by a 80 foot radius around Well 6.

February 2014 revision

Zone 2. The area described as follows using public land survey lines, less the town islands formed by City Corporate Boundaries, all within Township 12N, Range 4W: Commencing from the southwest corner of the SE ¼ of section 5, then north to the NW corner of the SE ¼ of section 5, then east to the southeast corner of the SW ¼ of the NE ¼ of section 5, then north to the northeast corner of the SW ¼ of the NE ¼ of section 5, then west to the northwest corner of the SW ¼ of the NW ¼ of section 5, then south to the southwest corner of the SW ¼ of section 5, then west to the point of origin.

13.34.080 Permitted Uses.

The following permitted uses in Zone 1 are subject to the separation distance requirements, Section 13.34.090, prohibited uses, Section 13.34.100, and applicable design and operational standards Section 13.34.130:

Public parks and play grounds, provided there are no on-site waste disposal or fuel storage tank facilities.

Wildlife and natural and woodland areas.

Biking, hiking, skiing, nature, equestrian and fitness trails.

Municipally sewered residential development.

Routine tillage, planting, and field management operations in support of agricultural crop production, where nutrients from legume, manure, and commercial sources are accounted for and credited toward crop nutrient need. The combination of all nutrient sources applied or available on individual fields may not exceed University of Wisconsin soil test recommendations for that field.

The following permitted uses in Zone 2 are subject to the separation distance requirements, Section 13.34.090, prohibited uses, Section 113.34.100, and applicable design and operational standards, Section 13.34.130:

All of the uses permitted in Zone 1.

Public parks and playgrounds, provided onsite wastewater shall be discharged to a holding tank or municipal sewer.

Single-family residences on a minimum lot of 40,000 square feet with a private on-site sewage treatment system receiving less than 8,000 gallons per day, which meets the County and State health standards for the effluent, and is in conformance with COMM 83, Wis. Adm. Code.

Residential use of above ground LP gas tanks for heating, not to exceed 1,000 gallons.

Commercial and industrial establishments that are municipally sewered and whose aggregate use, storage, handling and/or production of Regulated Substances does not exceed twenty (20) gallons or one hundred and sixty (160) pounds at any time.

A limited exclusion from the provision of Section 13.34.080 (B)(5) authorized for non-routine maintenance or repair of property or equipment. The aggregate of Regulated Substances in use, storage, handling, and/or production may not exceed fifty (50) gallons or four hundred (400) pounds at any time.

A limited exclusion from the provisions of Section 13.34.080 (B)(5) is authorized for each medical and research laboratory use, provided however, Regulated Substances shall be stored, handled or used in containers not to exceed five (5) gallons or forty (40) pounds of each substance and the aggregate inventory of Regulated Substances shall not exceed two hundred and fifty (250) gallons or two thousand (2,000) pounds.

A limited exclusion from the provisions of Section 13.34.080 (B)(5) is authorized for Regulated Substances which are cleaning agents, provided such cleaning agents are packaged for personal or household use or are present in the same form and concentration as a product packaged for use by the general public, and provided the aggregate inventory of such cleaning agents shall not exceed one hundred (100) gallons or eight hundred (800) pounds at any time. Citrus based, biodegradable cleaners are not considered a Regulated Substance. In no case shall Regulated Substances claimed under this exclusion include hydrocarbon or halogenated hydrocarbon solvents.

13.34.090 Separation Distance Requirements. The following separation distances based on NR 811 Wis. Adm. Code, shall be maintained:

Fifty feet between a well and storm sewer main.

Two hundred feet between a well and any sanitary sewer main, sanitary sewer manhole, lift station or single family residential fuel oil tank. A lesser separation distance may be allowed for sanitary sewer mains where the sanitary sewer main is constructed of water main materials and joints and pressure tested in place to meet current American Waterworks Association (AWWA) C600 specifications. In no case may the separation distance between a well and sanitary sewer main be less than 50 feet.

Four hundred feet between a well and a septic tank or soil adsorption unit receiving less than 8,000 gallons per day, a cemetery or a storm water drainage pond.

Six hundred feet between a well and any gasoline or fuel oil storage tank installation that has received written approval from the Wisconsin Department of Commerce (hereafter Commerce) or its designated agent under s. Comm 10.10, Wis. Adm. Code.

One thousand feet between a well and land application of municipal, commercial or industrial waste; boundaries of a landspreading facility for spreading of petroleum-contaminated soil regulated under Chapter NR 718, Wis. Adm. Code while that facility is in operation; industrial, commercial or municipal waste water lagoons or storage structures; manure stacks or storage structures; and septic tanks or soil adsorption units receiving 8,000 gallons per day or more.

Twelve hundred feet between a well and any solid waste storage, transportation, transfer, incineration, air curtain destructor, processing, wood burning, one time disposal or small demolition facility; sanitary landfill; any property with residual groundwater contamination that exceeds Chapter NR 140, Wis Adm. Code enforcement standards that is shown on the Department of Natural Resources' geographic information system registry of closed remediation sites; coal storage area; salt or deicing material storage area; gasoline or fuel oil storage tanks that have not received written approval from Commerce or its designated agent under s. Comm 10.10, Wis. Adm. Code; bulk fuel storage facilities; and pesticide or fertilizer handling or storage facilities.

Prohibited Uses.

The following uses are prohibited in Zone 1 and 2:

Buried hydrocarbon, petroleum or hazardous chemical storage tanks.

Cemeteries.

Chemical manufacturers (Standard Industrial Classification Major Group 28).

Coal storage.

Dry cleaners.

Industrial lagoons and pits.

Landfills and any other solid waste facility, except post-consumer recycling.

Manure and animal waste storage except animal waste storage facilities regulated by the County.

All mining including sand and gravel pits.

Pesticide and fertilizer dealer, transfer or storage facilities.

Railroad yards and maintenance stations.

Rendering plants and slaughterhouses.

Salt or deicing material storage.

Salvage or junk yards.

Septage or sludge spreading, storage or treatment.

Septage, wastewater, or sewage lagoons.

Private on-site wastewater treatment systems or holding tanks receiving 8,000 gallons per day or more.

Stockyards and feedlots.

Storm water infiltration basins without pre-treatment, including vegetative filtration and/or temporary detention.

Motor vehicle services, including filling and service stations, repair, renovation and body working.

Wood preserving operations.

Hazardous and/or toxic material storage or waste facilities.

In Zone 1, the provisional uses of section 13.34.120 are prohibited.

13.34.110 Classification of Use. Classification of a use as being permitted, prohibited or provisional shall be determined by an application submitted to the City of Viroqua Administrator. The application shall be in writing and shall describe in detail the use, activities and structures proposed along with the quantities, use of, storage and handling of all Regulated Substances. A scaled site map showing all building and structure footprints, driveways, loading docks, sidewalks, parking lots, storage yards and any other information deemed necessary for determination. In case of question as to the classification of a proposed use, the application shall be forwarded to the City of Viroqua Plan Commission for determination in accordance with the following procedure:

Application: The above described application shall be submitted to the City of Viroqua Administrator. The application will be then forwarded to the City of Viroqua Plan Commission. The City of Viroqua Plan Commission may request additional information as deemed necessary to facilitate a determination.

Investigation: The City of Viroqua Plan Commission shall make or have made such investigation in order to compare the nature and characteristics of the proposed use with those that are permitted, provisional or prohibited.

Determination: The City of Viroqua Plan Commission shall recommend use to the Common Council to determine the use as being permitted, prohibited or provisional. The determination of the City of Viroqua Common Council shall be rendered in writing within 60 days from receiving all requested information and shall include findings supporting the conclusion.

13.34.120 Provisional Use Permits

Any person may request a provisional use permit for certain uses, activities and structures within Zone 2 of the Groundwater Protection Overlay District not prohibited in Section 13.34.100.

Use, storage handling or production processing of Regulated Substances in excess of quantities outlined in Section 13.34.080 (B)(4-8) may be provisionally allowed in Zone 2 of the Groundwater Protection Overlay District.

All requests for a provisional use permit shall be submitted in writing to the City of Viroqua Administrator for a review of permit application materials. The request will then, if properly prepared, be forwarded for inclusion on the agenda of the next City of Viroqua Plan Commission meeting. The Provisional Use Permit Application shall include:

A site plan map set showing all building and structure footprints, driveways, sidewalks, parking lots, storm water management structures, groundwater monitoring wells, and 2-foot ground elevation contours. The plan set should also include: building plans (must include floor plans of typical floors and denote all entrances, exits, loading docks, building service areas, etc.), storage areas for Regulated Substances, grading plans showing existing and proposed grades and contours, proposed surface water drainage patterns, catch basin and storm sewer locations, connections to existing utilities and a construction site erosion control plan. The site plan set shall be developed in accordance with the Design Standards established for the Groundwater Protection Overlay District as defined in Section 13.34.130.

An operational plan and/or other documentation which describes in detail the use, activities, and structures proposed. The operational plan shall be developed in accordance with the Operational Standards established for the Groundwater Protection Overlay District as defined in Section 13.34.130.

An environmental risk assessment report prepared by a licensed environmental professional which details the risk to, and potential impact of, the proposed use, activities, and structures on groundwater quality.

An operational safety plan, which details the operational procedures for material processes and containment, best management practices, storm water runoff management, and groundwater monitoring as required.

A contingency plan which addresses in detail the actions that will be taken should a contamination event caused by the proposed use, activities, or structures occur.

The person making the request shall reimburse the City of Viroqua for consultant fees and expenses associated with this review at the invoiced amount, plus administrative costs.

All provisional use permits granted shall be subject to provisions that will include environmental and safety monitoring determined necessary to afford adequate protection of the public water supply. These provisions shall include, but not be limited to:

Provide current copies of all federal, state and local facility operation approval or certificates and on-going environmental monitoring results to the City of Viroqua.

Establish environmental or safety structures/monitoring to include an operational safety plan, material processes and containment, operations monitoring, best management practices, storm water runoff management, and groundwater monitoring.

Replace equipment or expand in a manner that improves the environmental and safety technologies being utilized.

Prepare, file and maintain a current contingency plan which details the response to any emergency which occurs at the facility, including notifying municipal, county and state officials. Provide a current copy to the City of Viroqua.

The City of Viroqua Plan Commission and Common Council shall decide upon a request for a provisional use permit. Any provisions above and beyond those specified in Section 13.34.120 (E) herein, may be applied to the granting of the provisional use permit by the City of Viroqua Plan Commission.

The Provisional Use Permit will become effective only after any costs incurred during the Provisional Use Permit application review are satisfied by the applicant.

Provisional use permits are non-transferable. In a case of business or property transfer, the new owner is responsible for applying for a new provisional use permit subject to subsections A-G of this Section.

13.34.130 Design and Operational Standards

The following Design Standards apply to permitted land use activities within Zone 1 and 2 of the Groundwater Protection Overlay District:

All parking lots exceeding eight (8) stalls, all sump pumps and all roof drains shall be connected to a storm sewer lateral or other apparatus. Use of drywells or other subsurface drains is prohibited.

No more than seventy percent (70%) of a lot shall be covered by impervious surfaces such as buildings or parking lots.

All parking lots shall be paved with asphalt or concrete.

All storm water conveyance shall be via a swale or a watertight storm sewer pipe.

All storm water retention/infiltration ponds shall, at a minimum, use a fore bay design intended to maximize natural filtration. The fore bay designs shall include spill containment measures, initial and secondary detainment weirs and/or outfall control valves.

Storm water and sanitary sewer mains must meet separation distance requirements as defined in Section 13.34.090.

New sanitary sewer mains must be pressure tested in place to meet current State of Wisconsin Department of Natural Resources Statutes, Chapter NR 110, and applicable local or project specific specifications.

The following Design Standards apply to Provisional Use activities within Zone 2 of the Groundwater Protection Overlay District:

All design standards listed in Section 13.34.130 (A).

Facilities that handle Regulated Substances shall have a minimum of one loading/unloading area designated for the handling of Regulated Substances. The designated loading/unloading area shall be designed with spill and/or runoff containment that is connected to a municipal sanitary sewer lateral. The loading/unloading area shall be designed to minimize precipitation or storm water run on from entering the sanitary sewer. Regulated Substances may be loaded/unloaded only in a designated handling area.

Storage areas for Regulated Substances shall be designed with secondary containment capable of controlling one hundred twenty five (125%) of the maximum design capacity of the liquid storage area.

Facilities involved in the handling of Regulated Substances will, when determined necessary by the City of Viroqua Plan Commission, prepare a groundwater monitoring plan.

All rail spurs used to transport Regulated Substances shall be designed to minimize infiltration and convey runoff to a storm water conveyance system. Rail car loading/unloading areas used to handle Regulated Substances shall be designed with spill and/or runoff containment that is connected to a municipal sewer lateral. The loading/unloading area shall be designed to minimize precipitation or storm water run on from entering the sanitary sewer.

The following Operational Standards apply to permitted land use activities within Zone 1 and 2 of the Groundwater Protection Overlay District:

No outdoor storage of product, material, or equipment shall be allowed other than that approved through the provisional use permitting process shall be allowed. Any designated outdoor storage area shall be an impervious surface paved with concrete or asphalt and have secondary containment when applicable.

Regulated Substances associated with paving, the pouring of concrete, or construction for which all necessary permits have been obtained may be handled in the Groundwater Protection Overlay District, provided such Regulated Substances are present at the construction site for which the permits have been issued and do not pose a real and present danger of contaminating surface and/or groundwater. For the onsite storage of fuel for vehicles or other equipment, which may be associated with such construction activity, the fuel storage containers shall be secondarily contained. Regulated Substances not used in the construction process and all wastes generated during construction shall be removed from the construction site not later than at the time of the completion of the construction. If construction activity has ceased for 30 days, all Regulated Substances shall be removed from the site until such time as the construction activity is to resume.

The use of deicing salt or other chemical deicing materials shall be minimized and used only when threats to safety occur.

The following Operational Standards apply to Provisional Use activities within Zone 2 of the Groundwater Protection Overlay District:

All Operational Standards listed in 13.34.130 (C).

Except in the case of seasonal discontinuation of operation, the owner or operator of any non-residential property that becomes unoccupied or has discontinued operation for a period of 30 consecutive days shall remove all Regulated Substances from the property, except those approved to be exclusively used for heating, cooling, and providing electrical lighting for the premises, within 30 days after the date upon which the property initially became unoccupied or the operation discontinued. The owner or operator shall secure the Regulated Substances on the property until they have been removed. The owner or operator shall notify the City of Viroqua Administrator in writing of the date of the cessation of operation or the property becoming unoccupied no later than the day upon which the operation actually ceases or the property becomes unoccupied, and such notification shall include the owner's name, phone number, and address and the operator's name, phone number, and forwarding address.

Truck, truck trailer, rail car, or tank truck loading and unloading procedures for Regulated Substances shall meet the minimum requirements of the U.S. Department of Transportation (DOT) and Wisconsin DOT.

No truck, trailer, rail car, or tank truck shall be used for onsite storage of Regulated Substances. Regulated Substances shall be transferred from the delivery vehicle to the Regulated Substance storage area as soon as feasibly possible.

Loading and unloading procedures for Regulated Substances shall occur in designated loading/unloading areas. Warning signs and chock blocks shall be provided in the loading and unloading area to prevent premature vehicular departure.

Daily visual inspections of Regulated Substances shall be conducted to check for container damage or leakage, stained or discolored storage surfaces in all storage areas, excessive accumulation of water in outdoor curbed areas, and to ensure that dike drain valves are securely closed in outdoor curbed areas. These inspections are the responsibility of the owner of the facility

Storage areas for Regulated Substances shall have access restricted to properly authorized and trained personnel.

Companies shall provide adequate training to ensure that established operational safety plans and contingency plans are understood by all authorized personnel.

Companies using or producing Regulated Substances shall have an adequate quantity of spill response equipment and supplies onsite to contain and cleanup spills of Regulated Substances.

Annual spill prevention briefings shall be provided to authorized personnel by company management to ensure adequate understanding of the operational safety and contingency plans. These briefings shall highlight any past spill events or failures and recently developed precautionary measures. Records of these briefings shall be kept for documentation purposes.

Instructions and phone numbers for reporting spills to the City of Viroqua Fire Department and other local, State, and Federal agencies shall be posted in all areas where Regulated Substances are handled.

13.34.140 Requirements for Existing Facilities.

Existing facilities within zone 1 and Zone 2 of the Groundwater Protection Overlay District at the time of enactment of such district which use, store, handle, or produce Regulated Substance in excess of quantities outlined in Section 13.34.080(B)(4-8), and all other facilities which are considered a prohibited use in Prohibited Uses, Section I, or a provisional use in Provisional Use Permits, Section K, all of which are incorporated herein as if fully set forth, shall be subject to the following requirements:

Such facilities as defined in Section 13.34.140(A) which exist within the district at the time of enactment of a district shall provide copies of all current, revised or new federal, state and local facility operation approvals, permits or certificates; operational safety plans; and on-going environmental monitoring results to the City of Viroqua.

Such facilities as defined in Section 13.34.140(A) which exist within the district at the time of enactment of a district shall have the responsibility of devising, filing and maintaining, with the City of Viroqua, a current contingency plan which details how they intend to respond to any emergency which may cause or threaten to cause environmental pollution that occurs at their facility, including notifying municipal, county and state officials.

Such facilities as defined in Section 13.34.140(A) cannot engage in or employ a use, activity, or structure listed in prohibited uses, Section 13.34.100, or in provisional uses, Section 13.34.120, which they did not engage in or employ at the time of enactment of a district, and can only expand, replace in kind or rebuild those present uses, activities, equipment, or structures on the site or property of record associated with the facility at the time of enactment of a district, and in a manner that improves the environmental and safety technologies already being utilized. No existing use, activity, or structure listed as a prohibited use or provisional use shall be expanded, replaced in kind, or rebuilt unless a provisional use permit is granted for such expansion, replacement, or rebuilding. This section does not apply to normal maintenance or minor repairs.

Such facilities as defined in Section 13.34.140(A) cannot change the quantity or type of Regulated Substances handled, used or stored by the facility at the time of enactment of a district unless a provisional use permit is granted for such change in quantity or type.

13.34.150 Changing Technology.

The uses prohibited by this district are prohibited based upon the combined pollution experience of many individual uses, and the technology generally employed by a particular use considered being of a high risk for pollution to the groundwater resource. As the technology of other uses change to low or non-risk materials or methods, upon petition from such use, after conferring with the Plan Commission, and after appropriate public notice and hearing, the City of Viroqua, through appropriate procedures and actions to change these provisions of the City of Viroqua Municipal Code, may remove from the designated prohibited uses such uses as are demonstrated convincingly that they no longer pose a groundwater pollution hazard.

In dealing with uses which attempt to become permissible, under the terms of this district, by continuing to utilize pollutant materials but altering their processing, storage and handling, it is not the intention to accept alternate or reduced hazards as the basis for making a use permissible. It is the intention to continue a prohibition on such uses until the technology of the use removes reliance upon the pollutant materials or processes deemed to be a groundwater hazard.

13.34.160 Enforcement and Penalty.

Penalty. Any person who violates, neglects or refuses to comply with any of the provisions of this ordinance shall be subject to a penalty as provided in Chapter 1.12 of the City of Viroqua Municipal Code.

Injunction. The City of Viroqua may, in addition to any other remedy, seek injunction or restraining order against the party alleged to have violated the provisions herein, the cost of which shall be charged to the defendant in such action.

Notice of Violation.

Any person found in violation of any provisions of this ordinance will be served with a written notice stating the nature of the violation and providing reasonable time for compliance.

The notice shall be served in the manner provided by the law for the service of civil processes. Where the address of the violator is unknown, service may be made upon the owner of the property involved at the tax-mailing address of the owner as shown on the County tax record.

Inspections. Subject to applicable provisions of law, the City of Viroqua Director of Public Works shall be permitted to enter private property at any reasonable time, with reasonable cause or with prior notification, for such purposes as inspection, observation, measurement, sampling, and records examination pertaining to the requirements of this Ordinance to ensure that activities are in accordance with the provisions of Sections 13.34.080 through 13.34.140. Upon request of the entity which is the subject of the inspection, and if permitted by the State Public Records Law, information obtained as a result of the inspection shall be maintained as confidential. If the owner or tenant does not consent to the entry of the appointed individual for the above stated purposes, the City of Viroqua may apply to a court of competent jurisdiction for an appropriate warrant or other authority to enter said property.

Vandalism. No person shall maliciously, willfully, or negligently break, damage, destroy, uncover, deface, or tamper with any structure, appurtenance, property, or equipment which is a part of or used in conjunction with water facilities of the City of Viroqua and/or any other protected public water supply, or which results in the violation of Sections 13.34.080 through 13.34.140.

Subject Area. The area subject to the provisions of this ordinance is the Groundwater Protection Overlay District as shown on the official Zoning Map of the City of Viroqua and as described in 13.34.080 and shown in Figure 1.

Determination of Applicability. It shall be the responsibility of any person owning real property and/or owning or operating a business within the Groundwater Protection Overlay District to make a determination of the applicability of Sections 13.34.080 through 13.34.140 as they pertain to the property and/or business, and failure to do so shall not excuse any violation of said sections.

Management.

No persons shall place, deposit, or permit to be deposited, store, process, use, produce, dispose of, transport, or discharge, hereinafter referred to as "handle," any Regulated Substance on public or private property within the Groundwater Protection Overlay District or in any area under the jurisdiction of said Groundwater Protection Overlay District, except as provided by law, statute, ordinance, rule or regulation.

Any violation of this Section is hereby determined to be a nuisance.

Spills, Leaks or Discharges.

Any person with direct knowledge of a spill, leak or discharge of a Regulated Substance within the Groundwater Protection Overlay District shall, if such spill, leak or discharge escapes containment or contacts a non-impervious ground surface and is not immediately and completely remediated, give notice to the City of Viroqua Fire Department utilizing the county wide 911 service and the City of Viroqua at the affected or potentially affected water treatment facility by telephone within thirty (30) minutes. The notification shall include at a minimum, the location of the incident, name and telephone number of the contacting party, date and time thereof, type of substance(s), concentration and volume, and control or corrective action taken. Such notification shall in no way alleviate other local, State, and Federal reporting obligations.

Any entity or person who spills, leaks or discharges said substance(s) shall be liable for any reasonable expense, loss or damages incurred by the City of Viroqua in response to such an incident, in addition to the amount of any fines imposed on account thereof under State and Federal law; said entity or person shall document and maintain sufficient records so as to reflect accurately the circumstances related to any such incident and develop and implement procedures to substantially eliminate the likelihood of reoccurrence of such spills, leaks or discharges as soon as practicable following the incident, but no later than one hundred eighty (180) days after the incident.

Cleanup Costs. As a substitute for, and in addition to any other action, the City of Viroqua may commence legal action against both the person who releases the contaminants and the owner of the facility whereupon the contaminants were released to recover the costs, together with the costs of prosecution. Any person who causes the release of any contaminants which may endanger or contaminate the municipal water supply system associated with a Groundwater Protection Overlay District shall immediately cease such discharge and immediately initiate clean up satisfactory to the City of Viroqua and the other state and federal regulatory agencies. The person who releases such contaminants and the person who owns the facility whereon the contaminants have been released shall be jointly and severally responsible for the cost of cleanup, consultant, or other contractor fees, including all administrative costs for oversight, review and documentation, including the City of Viroqua employees, equipment, and mileage.

13.34.170 Conflict, Interpretation and Severability.



Conflict and Interpretation of Provisions. If the provisions of the different chapters of this Code conflict with or contravene each other, the provisions of each chapter shall prevail as to all matters and questions arising out of the subject matter of such chapter. In their interpretation and application, the provisions of this ordinance shall be held to be the minimum and are not deemed a limitation or repeal of any other power granted by Wisconsin Statutes. Where any terms or requirements of this ordinance may be inconsistent or conflicting, the most restrictive requirements or interpretations shall apply.

Severability of Code Provisions. If any section, subsection, sentence, clause or phrase of the Code is for any reason held to be invalid or unconstitutional by reason of any decision of any court of competent jurisdiction, such decision shall not affect the validity of any other section, subsection, sentence, clause or phrase or portion thereof. The City of Viroqua Council hereby declares that they would have passed this Code and each section, subsection, sentence, clause, phrase or portion thereof irrespective of the fact that any one or more sections, subsections, sentences, clauses, phrases or portions may be declared invalid or unconstitutional.

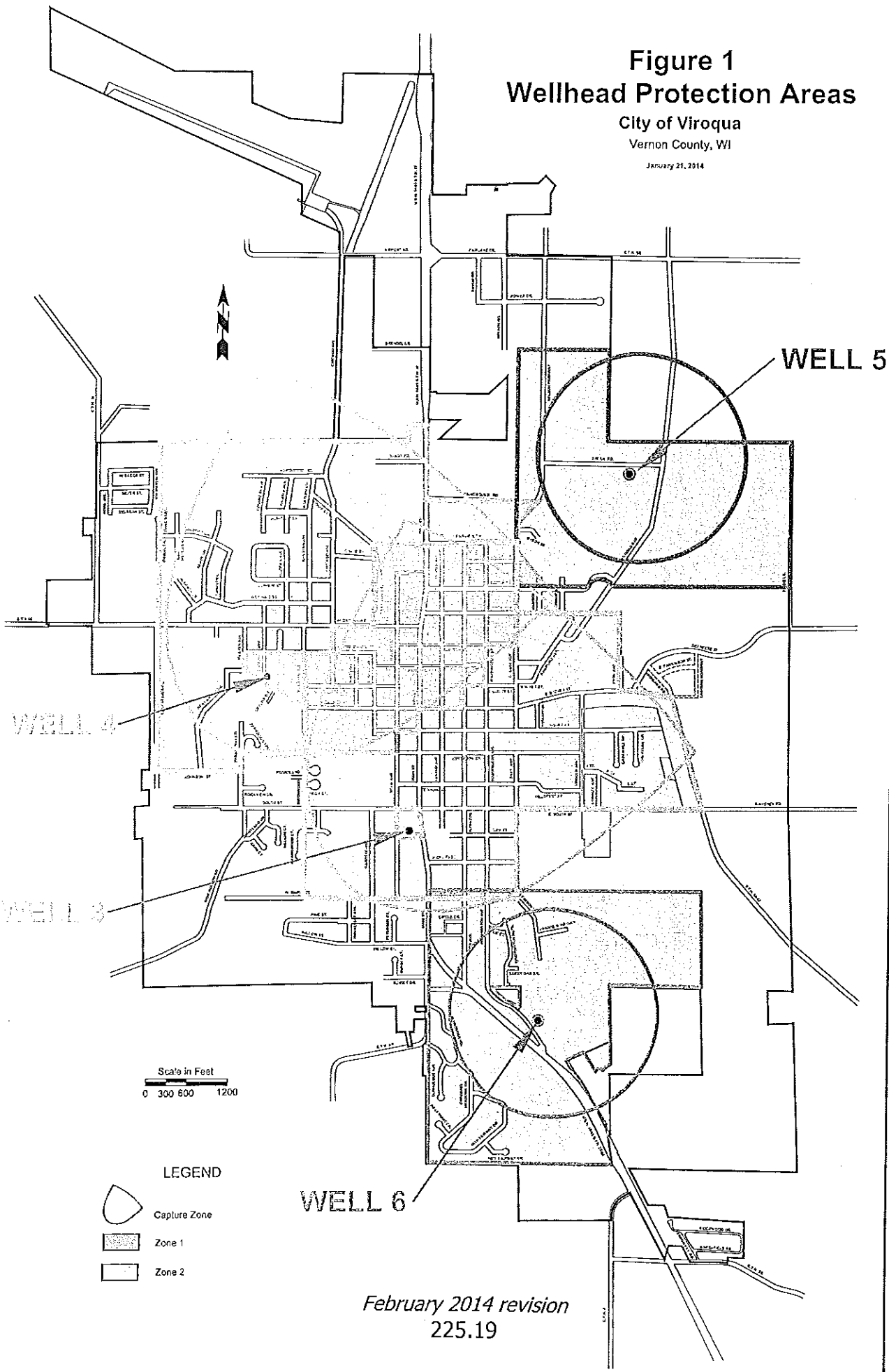
Figure 1
Wellhead Protection Areas
City of Viroqua
Vernon County, WI
January 21, 2014



Scale in Feet
0 300 600 1200

- LEGEND**
-  Capture Zone
 -  Zone 1
 -  Zone 2

WELL 6

February 2014 revision
225.19

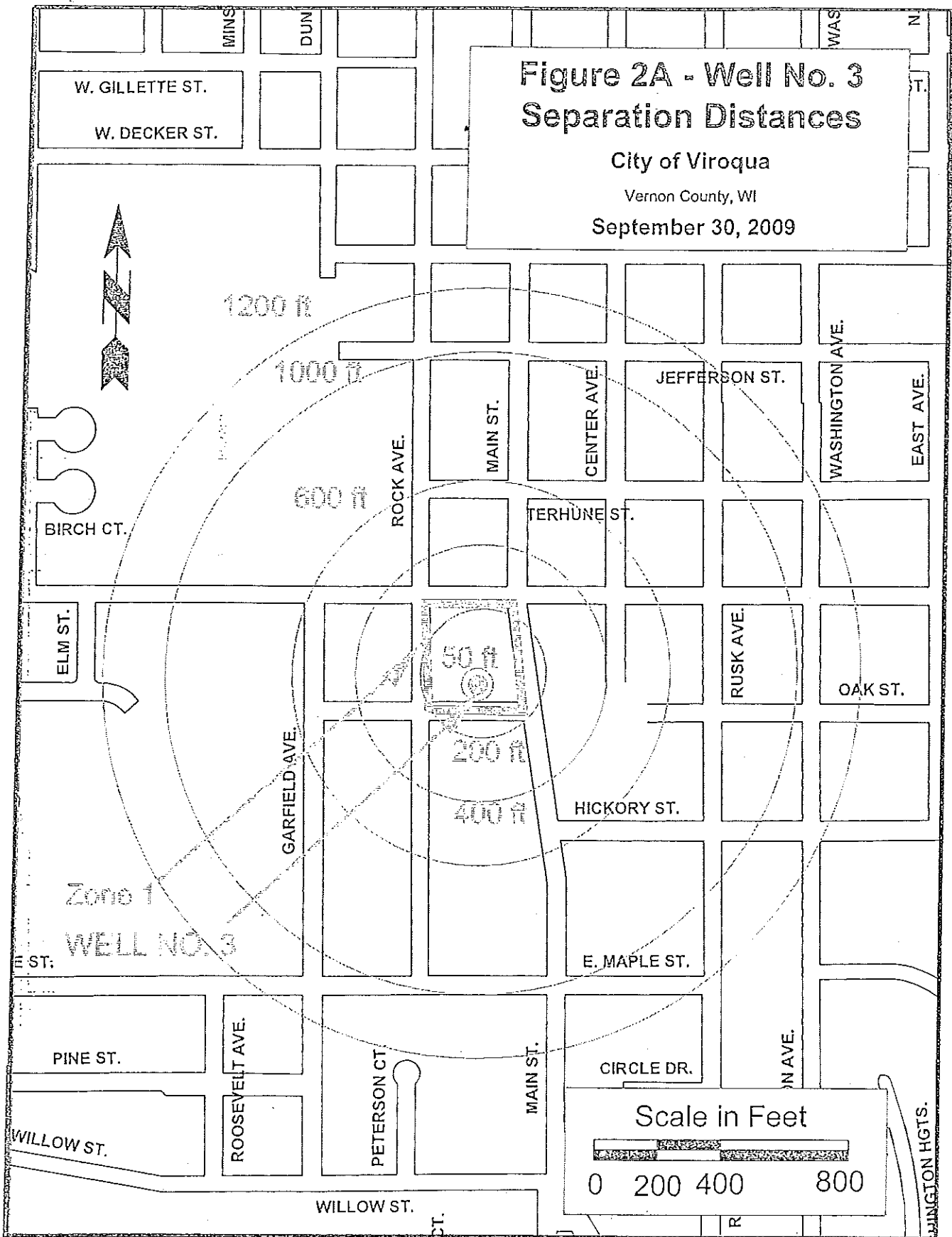

Figure 2B - Well No. 4 Separation Distances

City of Viroqua

Vernon County, WI

September 30, 2009

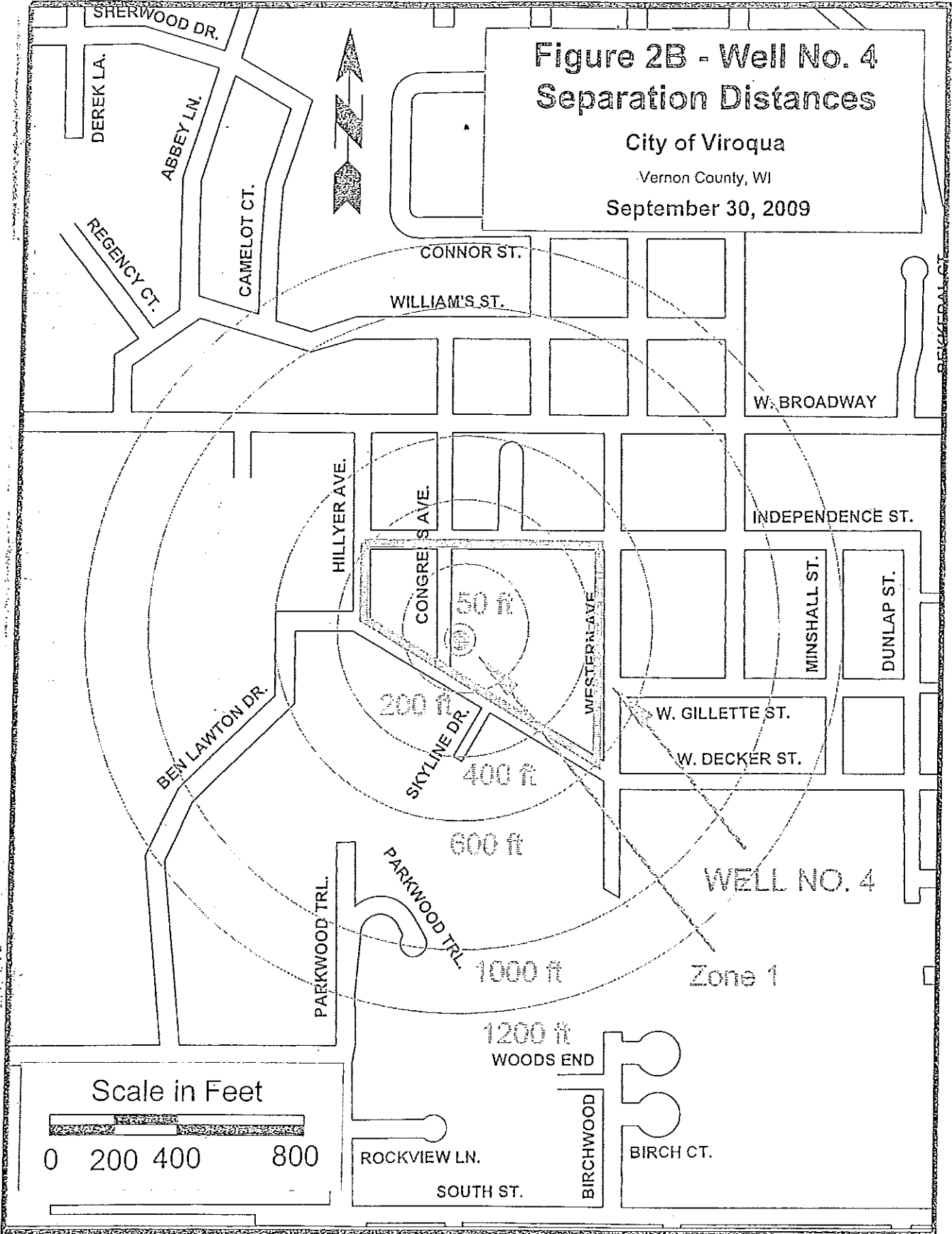
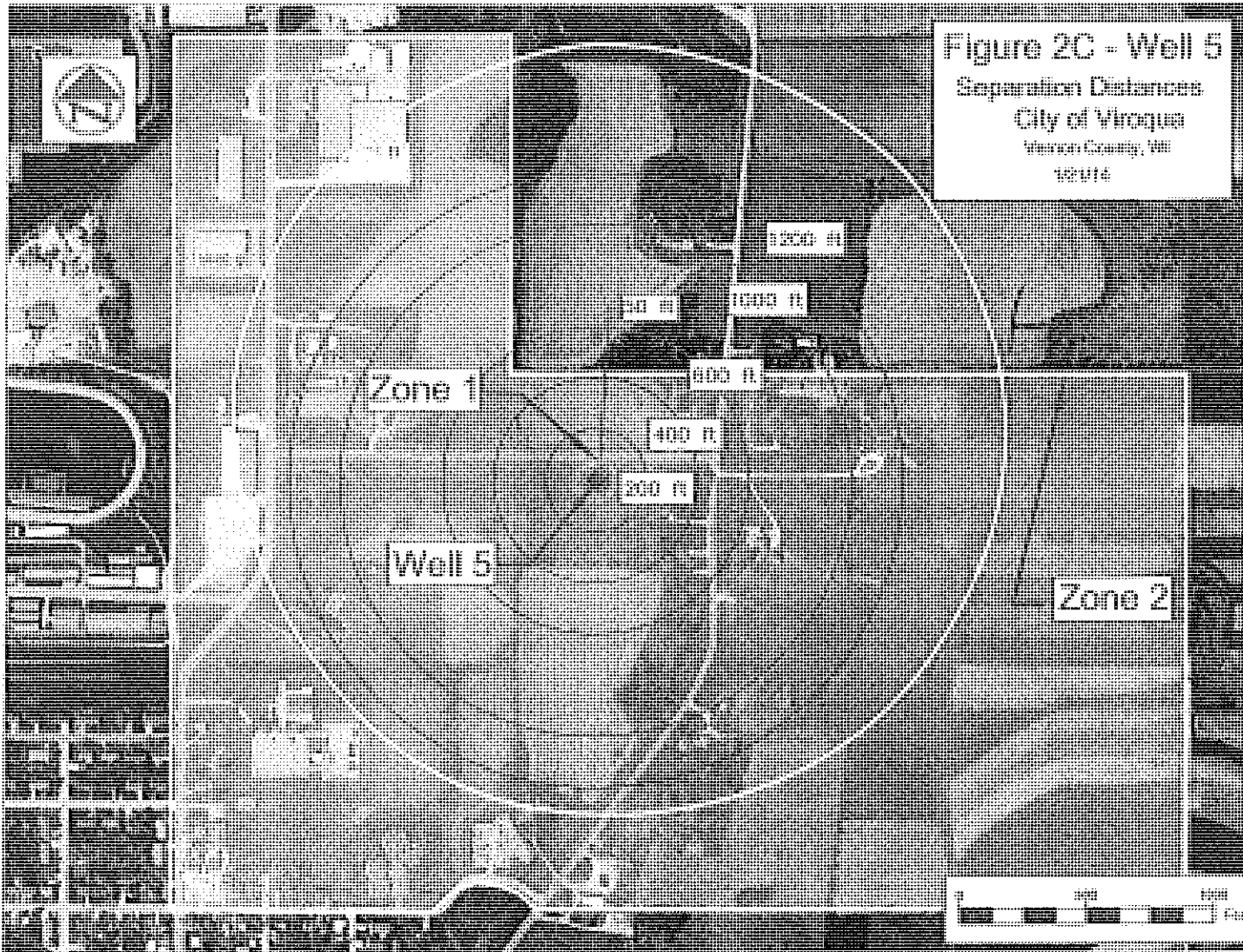
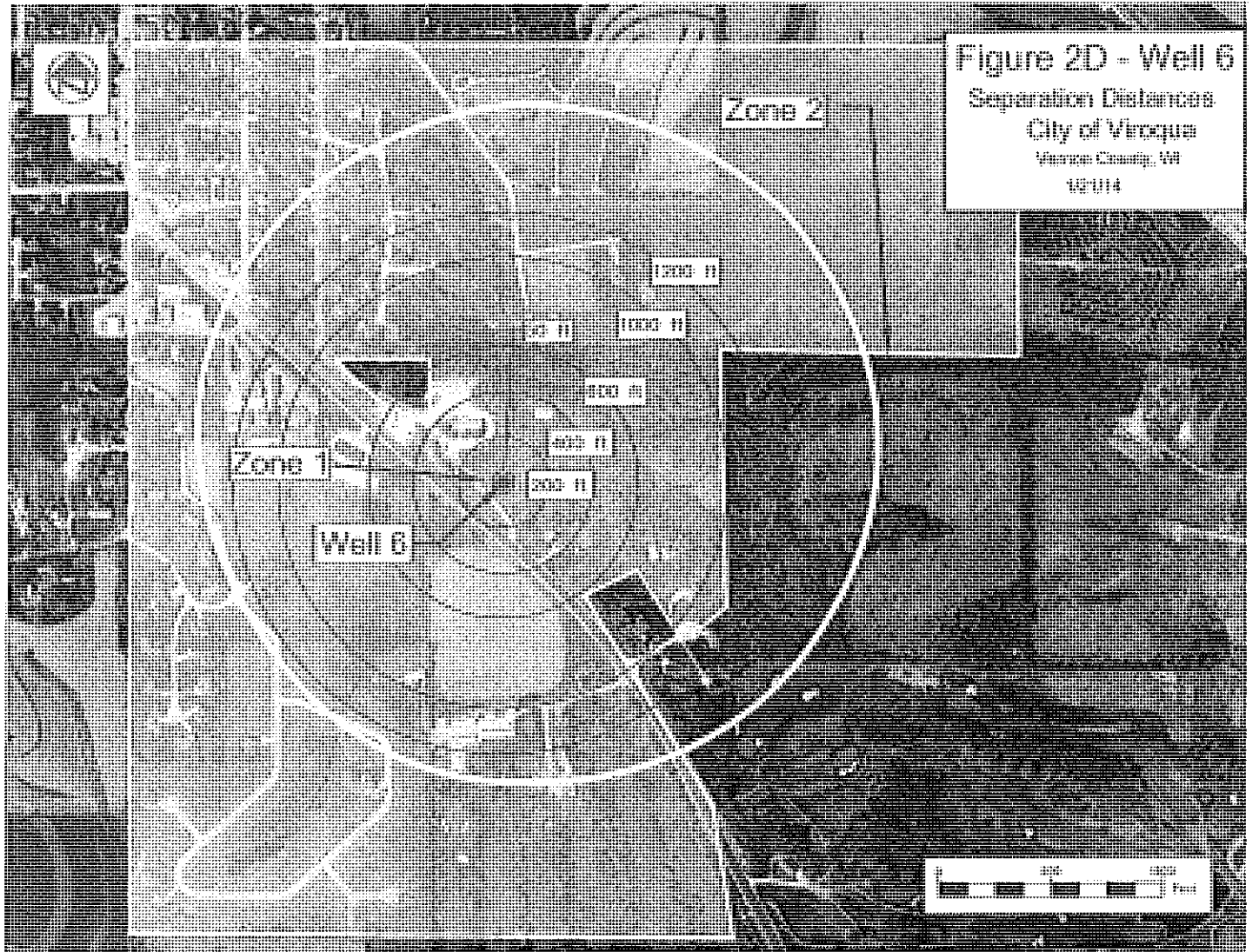

Figure 2C - Well 5
Separation Distances
City of Viroqua
Verison County, WI
12/014



February 2014 revision
225.22



February 2014 revision
225.23

Title 14

(RESERVED)

Title 15BUILDINGS AND CONSTRUCTION; FIRE CODEChapters:

- 15.04 General Building Code Provisions
- 15.06 Plumbing Code
- 15.10 Heating, Ventilating and Air Conditioning Code
- 1 5.15 Electrical Code
- 15.16 Penalties and Violation
- 15.18 One-family and Two-family Dwelling Code
- 15.19 Permit and Inspection fees
- 1 5.20 Fire Code

Chapter 15.04GENERAL BUILDING CODE PROVISIONSSections:

- 15.04.010 General Building Code Provisions
- 15.04.020 Building Permits and Inspection
- 15.04.030 Construction Standards; Codes Adopted.
- 15.04.040 New Methods and Materials.
- 15.04.050 Unsafe Buildings.
- 15.04.060 Disclaimer on Inspections.
- 15.04.070 Garages.
- 15.04.080 Regulation and Permit for Razing Buildings.
- 15.04.090 Abandoned Premises and Protection of Property; Fill Dirt
- 15.04.100 Discharge of Clear Waters.
- 15.04.110 Regulations for Moving Buildings.
- 15.04.130 Severability.

15.04.010 Building Code

(a) . This Chapter shall be known as the "Building Code of the City of Viroqua" and will be referred to in this Chapter as "this Code," "this Chapter" or "this Ordinance."

(b) Purpose. This Chapter provides certain minimum standards, provisions and requirements for safe and stable design, methods of construction and uses of materials in buildings and/or structures hereafter erected, constructed, enlarged, altered, repaired, moved, converted to other uses or demolished and regulates the equipment, maintenance, use and occupancy of all such buildings and/or structures. Its purpose is to protect and foster the health, safety and well being of persons occupying or using such buildings and the general public.

(c) Scope. New buildings hereafter erected in, or any building hereafter moved within or into the City, shall conform to all the requirements of this Chapter except as they are herein specifically exempted from part or all of its provisions. Any alteration, enlargement or demolition of an existing building and any installation therein of electrical, gas, heating, plumbing or ventilating equipment which affects the health or safety of the users thereof or any other persons is a "new building" to the extent of such change. Any existing building shall be considered a "new building" for the purposes of this Chapter whenever it is used for dwelling, commercial or industrial purposes, unless it was being used for such purpose at the time this Chapter was enacted. The provisions of this Chapter supplement the laws of the State of Wisconsin pertaining to construction and use and the Zoning Codes of the City and amendments thereto to the date this Chapter was adopted and in no way supersede or nullify such laws and the said Zoning Codes. (Ord 08OR002)

15.04.020 Building Permits and Inspection

(a) Permit Required.

(1) General Permit Requirement. No building of any kind shall be moved within or into the City and no new building or structure, or any part thereof, shall hereafter be erected, or ground broken for the same, or enlarged, altered, moved, demolished, razed or used within the City, except as herein provided, until a permit therefor shall first have been obtained by the owner or his or her authorized agent from the inspector.

(2) Alterations and Repairs. The following provisions shall apply to buildings altered or repaired:

a. Alterations. When not in conflict with any regulations, alterations to any existing substandard type of construction, which involves either beams, girders, columns, bearing or other walls, room, heating and air conditioning systems, arrangement, light and ventilation, changes in location of exit stairways or exits, or any or all of the above, then such existing construction shall be made to conform to the minimum requirements of this Chapter applicable to such occupancy and use and given type of construction.

b. Repairs. Repairs for purposes of maintenance, or replacements in any existing building or structure which do not involve the structural portions of the building or structure or which do not affect room arrangement, light and ventilation, access to or efficiency of any existing stairways, or exits, fire protection, or exterior aesthetic appearance and which do not increase a given occupancy or use, shall be deemed minor repairs.

c. Alterations When Not Permitted. When any existing building or structure, which, for any reason whatsoever, does not conform to the regulations of this Chapter, has deteriorated from any cause whatsoever to an extent greater than fifty percent (50%) of the equalized value of the building or structure, no alterations or moving of such building or structure shall be permitted. Any such building or structure shall be considered a menace to public safety and welfare and shall be ordered vacated and thereafter demolished and debris removed from the premises.

d. Alterations and Repairs Required. When any of the structural members of any building or structure have deteriorated from any cause whatsoever to less than their required strength, the owner of such a building or structure shall cause such structural members to be restored to their required strength; failing in which the building or structure shall be considered a menace to public safety and shall be vacated and thereafter no further occupancy or use of the same shall be permitted until the regulations of this Chapter are complied with.

e. Extent of Deterioration. A building with extensive deterioration will be reported to the Public Property Committee for determination on whether it is repairable with final approval of the decision by the City Council.

(b) Application. Application for a building permit shall be made in writing upon a form furnished by the inspector or its designee and shall state the name and address of the owner of the land and also the owner of the building if different, the legal description of the land upon which the building is to be located, the name and address of the designer, the use to which said building is to be put, the number of occupants, and such other information as the inspector may require.

(c) Plans. With such application, there shall be submitted two (2) complete sets of plans and specifications, including a plot plan showing the location and dimensions of all buildings and improvements on the lot, both existing and proposed, dimensions of the lot, dimensions showing all setbacks of all buildings on the lot, type of monuments at each corner of lot, water courses or existing drainage ditches, easements or other restrictions affecting such property, seal and signature of surveyor or a certificate signed by the applicant and a construction erosion control plan setting forth proposed information and procedures needed for control of soil erosion, surface water runoff and sediment disposition at the building site. Plans, specifications and plot plans shall be drawn to a minimum scale of one-quarter (1/4) inch to one (1) foot. One (1) set of plans shall be returned after approval as provided in this or her Chapter. The second set shall be filed with the City. Plans for buildings involving the State Building Code shall bear the stamp of approval of the State Department of Commerce. One (1) plan shall be submitted which shall be signed by the designer. Plans for all new one (1) and two (2) family dwellings shall comply with the provisions of Department of Commerce regulations in the Wis. Adm. Code. The fee due the State of Wisconsin for the Wisconsin uniform building permit in accordance with Department of Commerce regulations in the Wis. Adm. Code, shall be paid.

(d) Waiver of Plans; Minor Repairs.

(1) Waiver. If the Inspector finds that the character of the work is sufficiently described in the application, the Inspector may waive the filing of plans for alterations, repairs or moving, provided the cost of such work does not exceed Two Thousand Dollars (\$2,000.00).

(2) Minor Repairs. The Inspector may authorize minor repairs or maintenance work on any structure or to heating, ventilating or air conditioning systems installed therein valued at less than One Thousand Dollars (\$1,000.00) as determined by the Inspector, which do not change the occupancy area, exterior aesthetic appearance, structural strength, fire protection, exits, light or ventilation of the building or structure without issuance of a building permit.

(e) Approval of Plans.

(1) If the inspector determines that the building will comply in every respect with all Ordinances and orders of the City and all applicable laws and orders of the State of Wisconsin, the Inspector shall issue a building permit within 10 days of application which shall state the use to which said building is to be put, which shall be kept and displayed facing the main street of the site. After being approved, the plans and specifications shall not be altered in any respect which involves any of the above-mentioned Ordinances, laws or orders, or which involves the safety of the building or the occupants, except with the written consent of the inspector.

(2) In case adequate plans are presented for part of the building only, the inspector, in his or her discretion, may issue a permit for that part of the building before receiving the plans and specifications for the entire building.

(f) Inspection of Work. The Inspector, upon notification by the permit holder or his or her agent in writing and upon forms furnished by the Inspector for that purpose, shall make the following inspections and shall either approve the construction inspected or shall notify the permit holder or his or her agent, in writing, wherein the construction fails to comply and shall establish a period of time to bring about compliance. Copies shall be forwarded to all parties concerned. Approval of inspection shall be indicated by initialing or stamping the permit placard on the job site on a space provided for that purpose:

(1) Footing and foundation Inspection. To be requested and made after the placement of forms, shoring and reinforcement, where required, and prior to the placement of footing materials. Where below-grade drain tiles, waterproofing or exterior insulation is required, the foundation shall be inspected prior to backfilling.

(2) Rough-In Inspection. A rough inspection shall be performed for all inspection categories listed below after the rough work is constructed but before it is concealed. All categories of work for rough inspections may be completed before the notice for inspection is provided. The applicant may request one rough inspection or individual rough inspections. A separate fee may be charged for each individual inspection. Copies of all floors and truss plans are required on-site at this time.

1. general construction, including framing
2. Rough electrical
3. Rough Plumbing
4. Rough heating, ventilating and air conditioning
5. Basement drain tiles

(3) Insulation: An inspection shall be made of the insulation and vapor retarder after they are installed but before they are concealed.

(4) Final Inspection. A dwelling may not be occupied until a final inspection has been made that finds no violations that could reasonably be expected to affect the health or safety of a person using the dwelling. Occupancy may proceed in the case that the inspection has not been completed within five business days after notification of project completion..

(5) Erosion Control: Erosion control inspections shall be performed concurrently with all other required construction inspections. Additional inspections for erosion control may be performed by the delegated authority.

(g) Permit Lapses. A building permit shall lapse and be void unless building operations are commenced within sixty (60) days or if construction has not been completed within twenty-four (24) months from the date of issuance thereof.

(h) Issuance of Occupancy Permit and Revocation of Permit. No new building shall be occupied or otherwise used prior to the issuance of an occupancy permit. After the issuance of an occupancy permit, but before the issuance of a certificate of compliance, such building may be occupied or used only with the permission of the Inspector. Such permit shall be in writing and shall state the type of use which is permitted. The permit may be revoked at the discretion of the Inspector, upon thirty (30) days' notice to the user or occupant of the building. The revocation of a building permit or a permit to use shall not prevent such use of the building as was permissible prior to the issuance of such permit unless alterations have been made therein which increase the fire hazard or impair the safety or health conditions pertaining to such building.

(i) Revocation of Permits.

(1) The inspector may revoke any building, plumbing, HVAC or electrical permit, certificate of occupancy, or approval issued under the regulations of this Chapter and may stop construction or use of approved new materials, equipment, methods of construction, devices or appliances for any of the following reasons:

a. Whenever the inspector shall find at any time that applicable ordinances, laws, orders, plans and specifications are not being complied with and that the holder of the permit refused to conform after written warning or construction has been issued to him or her.

b. Whenever the continuance of any construction becomes dangerous to life or property.

c. Whenever there is any violation of any condition or provisions of the application for permit or of the permit.

d. Whenever any false statement or misrepresentation has been made in the application for permit, plans, drawings, data specifications or certified lot or plot plan on which the issuance of the permit or approval was based.

e. Whenever there is a violation of any of the conditions of an approval or occupancy given by the inspector for the use of all new materials, equipment, methods or construction devices or appliances.

(2) The notice revoking a building, plumbing, HVAC or electrical certificate of occupancy or approval shall be in writing and may be served upon the applicant of the permit, owner of the premises and his or her agent, if any, and on the person having charge of construction.

(3) A revocation placard shall also be posted upon the building, structure, equipment or premises in question by the inspector.

(4) After the notice is served upon the persons as aforesaid and posted, it shall be unlawful for any person to proceed thereafter with any construction operation whatsoever on the premises, and the permit which has been so revoked shall be null and void, and before any construction or operation is again resumed, a new permit, as required by this Chapter, shall be procured and fees paid therefor, and thereafter the resumption of any construction or operation shall be in compliance with the regulation of this Chapter. However, such work as the inspector may order as a condition precedent to the re-issuance of the building permit may be performed, or such work as the inspector may require for the preservation of life and safety.

Display of Permit. Building permits shall be displayed where the authorized building or work is in progress at all times during construction or work thereon. (Ord 08OR002)

15.04.030 Construction Standards; Codes Adopted.

- (a) Portions of State Building Code Adopted. The Wisconsin Department of Commerce regulations in the Wis. Adm. Code (Wisconsin State Building Code) are hereby adopted and made a part of this Chapter with respect to those classes of buildings to which this Building Code specifically applies. Any future amendments, revisions and modifications of said regulations incorporated herein are intended to be made a part of this Code.
- (b) Terms. The building terms used in this Chapter shall have the meaning given them in the State Building Code.
- (c) Dwellings. The term "dwelling" includes every building occupied exclusively as a residence.
- (d) Workmanship. Workmanship in the fabrication, preparation and installation of materials shall conform to generally accepted good practice.
- (e) Conflicts. If, in the opinion of the Inspector, the provisions of the State Building Code adopted by this Section shall conflict with the provisions of the Federal Housing Administration standards in their application to any proposed building or structure, the Inspector shall apply the most stringent provisions in determining whether or not the proposed building meets the requirements of this Section. (Ord 08OR002)

15.04.040 New Methods and Materials.

- (a) All materials, methods of construction and devices designed for use in buildings or structures covered by this Section and not specifically mentioned in or permitted by this Section shall not be so used until approved in writing by the State Department of Commerce for use in buildings or structures covered by the Wisconsin State Building Code, except sanitary appliances, which shall be approved in accordance with the State Plumbing Code.
- (b) Such materials, methods of construction and devices, when approved, must be installed or used in strict compliance with the manufacturer's specifications and any rules or conditions of use established by the State Department of Commerce. The data, test and other evidence necessary to prove the merits of such material, method of construction or device shall be determined by the State Department of Commerce. (Ord 08OR002)

15.04.050 Unsafe Buildings.

- (a) Whenever the Inspector finds any building or part thereof within the City to be, in the Inspector's judgment, so old, dilapidated or out of repair as to be dangerous, unsafe, unsanitary or otherwise unfit for human occupancy or use and so that it would be unreasonable to repair the same, the Inspector shall order the owner to raze and remove such building or part thereof or, if it can be made safe by repairs, to repair and make safe and sanitary, or to raze and remove at the owner's option. Such order and proceedings shall be as provided in Sec. 66.0413, Wis. Stats.
- (b) Where the public safety requires immediate action, the Inspector shall enter upon the premises with such assistance as may be necessary and cause the building or structure to be made safe or to be removed, and the expenses of such work may be recovered by the City in an action against the owner or tenant. (Ord 08OR002)

15.04.060 Disclaimer on Inspections.

The purpose of the inspections under this Chapter is to improve the quality of housing in the City of Viroqua. The inspections and the reports and findings issued after the inspections are not intended as, nor are they to be construed, as a guarantee. In order to so advise owners and other interested persons, the following disclaimer shall be applicable to inspections hereunder: "These findings of inspection contained herein are intended to report conditions of noncompliance with code standards that are readily apparent at the time of inspection. The inspection does not involve a detailed examination of the mechanical systems or the closed structural and nonstructural elements of the building and premises. No warranty of the operation, use or durability of equipment and materials not specifically cited herein is expressed or implied." (Ord 08OR002)

15.04.070 Garages.

Private garages shall be built in accordance with the general construction standards established in the Wisconsin Uniform Dwelling Code and City Zoning Code. Whenever a garage is constructed as part of any building, the ceiling and the walls or wall separating the garage from other portions of the building shall be of fire-restrictive construction as specified in Department of Commerce regulations in the Wis. Adm. Code. (Ord 08OR002)

15.04.080 Permit - Demolition.

A. No person shall demolish any building or structure without first making application for a permit and the permit being issued. (Ord. 13OR002)

B. The applicant shall complete and file with the building inspector a written application on a form furnished by the inspector, which shall include the name and address of the applicant and name and address of owner if other than applicant, description of the property, its street address, name of any contractor, the method of proposed demolition, the destination of demolition material, plans for protection of public facilities and disconnection of utilities, identification and proposed disposition of any hazardous materials, the proposed date of demolition and the date by which demolition will be completed.

C. The application shall also describe any proposed improvements to the property after demolition and the intended use of the property after demolition.

D. A permit will not be issued for demolition if the ensuing use is neither a permitted use nor a conditional use not yet allowed by the City.

E. Upon receipt of the application the building inspector shall furnish a copy to the Historic Preservation Commission (HPC) for comment; if the inspector receives no comment from the Commission within 15 business days after HPC notification, and the application is otherwise in order, the permit shall be granted. No demolition permit shall be denied solely because the property may be suitable for designation as an historic structure unless the owner consents.

F. The application for the permit, and the permit itself, shall be substantially as follows:

APPLICATION FOR PERMIT TO DEMOLISH A BUILDING

Name and address of the applicant: _____

Name and address of owner if other than applicant: _____

Description of the structure to be demolished (such as: house; garage; shed; block building etc):

Street address of property where demolition is to occur:

Name of any contractor:

Method of proposed demolition:

Destination of demolition material:

Plans for protection of public facilities and disconnection of utilities:

Identification and proposed disposition of any hazardous materials:

Proposed date of demolition:

Date by which demolition will be completed:

Describe any proposed improvements to the property after demolition:

Describe the intended use of the property after demolition:

Signature of applicant: _____

Date: _____

Note: Clerk to mail copy of application to Chairman of HPC and two designated members

PERMIT TO DEMOLISH A BUILDING

Permit is hereby granted to _____ to demolish a building described in the application for the permit signed and dated the _____ day of _____, 20____, under the circumstances, and within the time, described in the application, and on the condition that all ordinances of the City of Viroqua, and all laws of the State of Wisconsin and the United States, are complied with.

This permit is for the demolition of the structure described in the permit the street address of which is:

This permit expires at midnight on the _____ day of _____, 20____, the date by which the demolition will be completed according to the application.

Date when a copy of application for permit was mailed to the Viroqua Historic Preservation Commission:

Signature of building inspector: _____

Date: _____

15.04.090 Abandoned Premises and Protection of Property; Fill Dirt

(a) Abandoned Excavations. Any excavation which exists for thirty (30) days or more where construction has not been commenced therein shall be considered abandoned and shall be

February 2013 revision

refilled and leveled to grade by the owner of such lot or parcel of land within ten (10) days after receiving a written notice from the Inspector of such requirement; upon the failure of such owner to comply with such requirement within the stated period, the work may be done by the City or its agent and the expense thereof shall be assessed against such lot or parcel of land as a special tax pursuant to Sec. 66.0627, Wis. Stats., to be collected in the same manner as are other real estate taxes.

(b) Vacant Buildings. Whenever any building or structure is vacant and the doors and windows or any part thereof have been removed or opened, leaving the interior of such building or structure exposed to the elements and accessible to trespassers, then such building or structure shall be deemed to be dangerous, unsafe and a menace to public safety. The Inspector shall give the owner thereof written notice to secure said building or structure and comply with City Code requirements within thirty (30) days of the date of said notice. Failure to comply with said written notice shall be sufficient grounds for the Inspector to order said building or structure to be razed and removed.

(c) Protection of Adjoining Property. When the owner of any lot or plot of land, or the City, in making improvements, is about to excavate or cause an excavation to be made, which excavation in any way affects any building or structure on any adjoining lot, a notice shall be given to all owners of adjoining lots at least ten (10) days prior to commencing the excavation in order to give the adjoining owners a reasonable opportunity to protect their property at their own expense according to law. Such notice shall describe the extent and character of the excavation work about to be done.

(d) Transfer of Solid Fill. No person, firm or corporation shall transfer to, dump or place upon lands, public or private, solid fill within the City of Viroqua without first obtaining a permit therefor:

(1) Application. Application for a permit to transfer, place or dump solid fill within the City of Viroqua shall be made by the owner of the lands to be filled or his or her designated agent in writing to the Inspector upon an application furnished by the City. The applicant shall set forth upon the application form the following information:

- a. Proposed route for hauling fill;
- b. Other equipment involved in fill operation;
- c. Descriptions and source of fill material;
- d. Grading plan indicating final limits and finished grade of fill area.

(2) Fill Material. Fill material shall be clean, inert material free from organic material, brush, garbage and material subject to organic decomposition. Where necessary, to avoid dust or similar litter, all material shall be wetted down before transporting. Fill containing items such as hollow containers, appliances and equipment subject to subsequent collapse or settlement is prohibited. Generally, material such as earth fill and broken concrete of a size approved by the Inspector or his or her designee will be classified as acceptable fill subject to other permit requirements.

(3) Permits. The Inspector is authorized to issue a filling permit to each applicant when the inspector is satisfied that the fill material meets the requirements in Subsection (2) above and that the filling operation will not create noise, traffic or other problems detrimental

to the residents of the area of the City in which said filling is taking place; the Inspector shall not authorize any filling between the hours of 5:00 p.m. and 8:00 a.m. on weekdays, nor at any time on Saturday, Sunday or on a statutory holiday; the Inspector shall further restrict the hours of filling or the number of trucks involved based upon the location of the filling operation and the traffic conditions of the area where the filling is being placed. The permit shall be for a period not to exceed three (3) consecutive months in a calendar year. Permit applications for subsequent years, when filling operations span a period of several years, will be subject to conditions and fees governing initial applications.

(4) Other Regulations. Filling operations also shall be subject to all applicable ~~county~~, state or federal license or permit regulations. Filling operations shall not block a natural drainage course.

(5) Exceptions. The provisions of this section relating to the transfer of solid fill shall not apply to customary top dressing or fertilizing of lawns and gardens nor shall they apply to the construction of block or concrete patios, driveways or platforms permitted under City Ordinances. Filling involved in an operation requiring a building permit or a wrecking permit is exempt from this section of the Code. (Ord 08OR002)

15.04.100 Discharge of Clear Waters.

(a) Discharge. No person shall cause, allow or permit any roof drain, surface drain, subsoil drain, drain from any mechanical device, gutter, ditch, pipe, conduit, sump pump or any other object or thing used for the purposes of collecting, conducting, transporting, diverting, draining or discharging clear water from any part of any private premises owned or occupied by said person to discharge into a sanitary sewer.

(b) Nuisance. The discharge into a sanitary sewer from any roof drain, surface drain, subsoil drain, drain from any mechanical device, gutter, ditch, pipe, conduit, sump pump or any other object or thing used for the purposes of collecting, conducting, transporting, diverting, draining or discharging clear water from any part of any private premises is hereby declared to be a public nuisance and a hazard to the health, safety and well-being of the residents of the City and to the protection of the property.

(c) Groundwater. Roof water shall be directed to the street storm sewer or between buildings.

(e) Storm Sewer Lateral. Where municipal storm sewers are provided and it is deemed necessary by the property owner and/or the City to discharge clear waters from a parcel of land, a storm sewer lateral shall be installed and connected to the storm sewer main at the expense of the owner.

(f) Conducting Tests. If the Inspector or his or her designated agent suspects an illegal clear water discharge as defined by this Chapter or by any other applicable provision of the Wisconsin Administrative Code as it may, from time to time, be amended, the Inspector may, upon reasonable notice and at reasonable times, enter the private premises where such illegal clear water discharge is suspected and conduct appropriate tests to determine whether such suspected illegal clear water discharge actually exists. (Ord 08OR002)

15.04.110 Regulations for Moving Buildings.

(a) General Requirements.

(1) No person shall move any building or structure upon any of the public ways of the City of Viroqua without first obtaining a permit therefore from the Inspector and upon the payment of the required fee. Every such permit issued by the Inspector for the moving of a building shall designate the route to be taken, the conditions to be complied with and shall limit the time during which said moving operations shall be continued.

(2) Issuance of moving permit shall further be conditioned on approval of the moving route.

(b) Continuous Movement. The movement of buildings shall be a continuous operation during all the hours of the day and at night, until such movement is fully completed. All such operations shall be performed with the least possible obstruction to thoroughfares. No building shall be allowed to remain overnight upon any street crossing or intersection or so near thereto as to prevent easy access to any fire hydrant or any other public facility. Lights shall be kept in conspicuous places at each end of the building during the night.

(c) Street Repair. Every person receiving a permit to move a building shall, within one (1) day after said building reaches its destination, report that fact to the Inspector, inspect the trees, streets, highways and curbs and gutters over which said building has been moved and ascertain their condition. If the removal of said building has caused any damage to any street or highway, the person to whom the permit was issued shall forthwith place them in as good repair as they were before the permit was granted. On the failure of the said permittee to do so within ten (10) days thereafter to the satisfaction of the Director of Public Works, the City shall repair the damage done to such streets and hold the person obtaining such permit and the sureties on his or her bond responsible for the payment of same.

(e) Bond.

(1) Before a permit to move any building is granted by the Inspector, the party applying therefore shall give a bond in the sum of Ten Thousand Dollars (\$10,000.00) with good and sufficient sureties to be approved by the City Attorney conditioned, among other things, that said party will save and indemnify judgments, costs and expenses which may, in any way, accrue against the City and will save the City harmless against all liabilities, judgments, costs and expense in consequence of granting of such permit.

(2) Unless the Inspector, upon investigation, shall find it to be a fact that the excavation exposed by the removal of such building from its foundation shall not be so close to a public thoroughfare as to permit the accidental falling therein of travelers or the location, nature and physical characteristics of the premises and the exposed excavation, such as to make intrusion upon the premises and the falling into such excavation of any person unlikely, the bond required by this section shall be further conditioned upon the permittee erecting adequate barriers and within forty-eight (48) hours, filling in such excavation or adopting and employing such other means, devices or methods approved by the Inspector and reasonably adopted or calculated to prevent the occurrences set forth herein.

(f) The City shall require, in addition to said the said bond above indicated, public liability insurance covering injury to one (1) person in the sum of not less than One Hundred Thousand Dollars (\$100,000.00) and for one (1) accident in a sum not less than Two Hundred Thousand Dollars (\$200,000.00), together with property damage insurance in a sum not less than Fifty Thousand Dollars (\$50,000.00), or such other coverage as deemed necessary. (Ord 08OR002)

15.04.130 Severability.

If any section, clause, provision or portion of this Chapter, or of the Wisconsin Administrative Code adopted by reference, is adjudged unconstitutional or invalid by a court of competent jurisdiction, the remaining provisions shall not be affected. (Ord 08OR002)

Chapter 15.06

PLUMBING CODE

Sections:

- 15.06.010 Plumbing Code
- 15.06.020 Purpose and Scope of Plumbing Code.
- 15.06.030 State Regulations Adopted.
- 15.06.040 Plumbing Permits.
- 15.06.050 Plumbers to be Licensed.
- 15.06.070 Installation of Check Valves on All New Plumbing.

15.06.010 Plumbing Code

15.06.020 Purpose and Scope of Plumbing Code.

(a) The purpose of this Plumbing Code is to provide minimum regulations, provisions and requirements in the City of Viroqua to insure safety and adequacy to persons and property wherever plumbing is installed and to all alterations or improvements, including replacement of any apparatus or device pertaining to plumbing.

(b) The provisions of this section shall apply to every building, or portion of a building, devoted to a new use for which the requirements are in any way more stringent than the requirements covering the previous use.

(c) This section shall be known as the City of Viroqua Plumbing Code. (Ord 08OR002)

15.06.030 State Regulations Adopted.

Chapter 145, Wis. Stats.; the State Plumbing Code, and the Department of Commerce regulations in the Wis. Adm. Code, are hereby adopted and by reference made a part of this Chapter with the same force and effect as though set out in full. (Ord 08OR002)

15.06.040 Plumbing Permits.

(a) Required. No work contemplated by this Chapter shall be started until a permit therefor has been obtained from the Inspector, provided no permit shall be required for minor repairs to faucets or the removal of stoppages in soil and waste pipes.

(b) Application. The application shall be in writing upon forms which the Inspector shall provide and shall include the name of the owner and the description of the property on which the work is to be done, along with such pertinent information as the Inspector may require, and shall state that the property owner and the applicant will be bound by and subject to the provisions of this Chapter.

(c) Issuance, Term, Suspension and Revocation. When the Inspector is satisfied that the work proposed by the applicant can be done in conformity with the provisions of this Chapter and after the appropriate fees have been paid the Inspector shall issue the permit. Such permit shall allow for the continuous performance of the work named thereon. A permit shall automatically expire when work ceases for a period of sixty (60) days without good and reasonable cause for same as may be approved by the Inspector and shall automatically expire on completion of the work for which it is used, provided the Inspector may, upon notice, suspend or revoke such permit for violation of the provisions of this Title.

(d) Restrictions on Issuance.

(1) No plumbing permit shall be issued to any person who is in violation of this Title until such violation has been corrected.

(2) No plumbing permit shall be issued to any person against whom an order issued by the Inspector is pending, provided this restriction may be waived by the Inspector.

(e) Inspections

(1) All piping, traps and fixture of plumbing, water and sewer or drainage systems shall be kept uncovered until examined and approved. The following shall be inspected:

1. Sewer and all branches from the main to the building
2. Drains with all branches, receptacles and connections, soil waste and vent pipes, traps and all work known as roughing-in and underfloor work, rain water leader pipes and their roof extensions when within the walls of the building. All such piping shall be tested with water, air or smoke.
3. Water piping, fire protection services, wells, pumps, and all branches from the main to the building shall be tested at the maximum pressure under which they are to be used.
4. The entire water distribution system in all buildings, including meter loop and dipping to appliances or plumbing fixtures.
5. All repairs, relaying, alterations, and additions to the sewer drains, stacks, vents, waste pipes, or water services, water pipe and fixtures.
6. No person shall break open or make connections with any public sewer or water main, except in the presence of an employee of the Public Works. The connection shall be inserted at or before 3:00 PM.

(2) Final Inspection: When a plumbing and drainage system or water system is completed and the fixture is installed, the final inspection shall be made. No plumbing or drainage system shall be used until it has been inspected and approved, unless special permission is given by the inspector for temporary use. It is recommended that the plumber be on the job when the final inspection is made.

(3) Notice for Inspections: The plumber in charge shall notify the inspector at least 24 hours before any inspection or any connection with any existing sewer main or water main. The plumber in charge shall make arrangements that will enable the Inspector to reach all parts of the building readily. (Ord 08OR002)

15.06.050 Plumbers to be Licensed.

No person shall carry on the business of plumbing or do any plumbing work until he/she shall have first obtained the proper license to do so from the state. An unlicensed person may remove stoppages in drain pipes or repair valves or faucets. No person shall install plumbing unless at all times a licensed Wisconsin master plumber is in charge, who shall be responsible for the proper installation. (Ord 08OR002)

15.06.070 Installation of Check Valves on All New Plumbing.

Notwithstanding any other provisions of this Chapter, all new residential units/homes constructed within the City of Viroqua, within a secondary water pressure zone, shall have installed a check valve and a pressure-reducing valve. Said check valve is to be located on the home side of the water meter and said pressure-reducing valve shall be installed on the street side of the water meter. (Ord 08OR002)

Chapter 15.10

HEATING, VENTILATING AND AIR CONDITIONING CODE

Sections:

15.10.010 Heating, Ventilating and Air Conditioning Code

15.10.020 Purpose and Scope.

15.10.030 State Regulations.

15.10.040 Definitions.

15.10.050 Permits Required.

15.10.060 Inspections.

15.10.080 Liability for Damages.

15.10.010 Heating, Ventilating and Air Conditioning Code

15.10.020 Purpose and Scope.

(a) The purpose of this Heating, Ventilating and Air Conditioning Code is to provide minimum regulations, provisions and requirements in the City of Viroqua to insure safety and

adequacy to persons and property wherever heating, ventilating and air conditioning is installed and to all alterations or improvements, including replacement of any apparatus or device, pertaining to heating, ventilating and air conditioning.

(b) The provisions of this Chapter shall apply to every building, or portion of a building, devoted to a new use for which the requirements are in any way more stringent than the requirements covering the previous use.

(c) This Chapter shall be known as the "Heating, Ventilating and Air Conditioning Code of the City of Viroqua," and will be referred to as this "Code" or "this Chapter." (Ord 08OR002)

15.10.030 State Regulations.

(a) Adopted by Reference. The Department of Commerce regulations in the Wis. Adm. Code, and future amendments thereto, are adopted and by reference made a part of this Chapter with the same force and effect as though set out in full.

(b) To Be on File. A copy of the Heating, Ventilating and Air Conditioning Code shall be on file in the offices of the Inspector. (Ord 08OR002)

15.10.040 Definitions.

In this Chapter the following definitions shall be applicable:

(a) Heating System. Any combination of building construction, machines, devices or equipment, so proportioned, arranged, installed, operated and maintained as to produce and deliver in place the required amount and character of heating service.

(b) Ventilating. The process of supplying or removing air by natural or mechanical means, to or from any space.

(c) Furnace. A completely self-contained direct-fired automatically controlled, vented appliance for heating air by transfer of heat of combustion through metal to air and designed to supply heated air through ducts to spaces remote from the appliance location.

(d) Air Conditioning. The process of treating air to control simultaneously its temperature, humidity, cleanliness and distribution to meet the requirements of the conditioned space. (Ord 08OR002)

15.10.050 Permits Required.

(a) Permit Required. It shall be unlawful for a person, firm or corporation to construct, install, alter or repair any heating, ventilating or exhaust system (and appurtenance), replace a boiler, furnace, install stoker and conversion units in or for any building before securing a permit, except that in cases of emergency the contractor may proceed with the work and file the application for a permit within twenty-four (24) hours thereafter (Sundays and holidays excepted). A heating permit will not be required for the installation of electric baseboard or bathroom heaters when installed as auxiliary heat; that is, to supplement the existing heating system designed and installed to satisfy the load requirements of the space to be heated. The reference to appurtenances shall include direct heaters, cooling coils, central residential air conditioning (cooling) and similar devices affecting the safety or operation of the heating system.

(b) Application. The application shall be in writing upon forms which the Inspector shall provide and shall include the name of the owner and the description of the property on which the work is to be done, along with such pertinent information as the Inspector may require, and shall state that the property owner and the applicant will be bound by and subject to the provisions of this Chapter.

(c) Issuance, Term, Suspension and Revocation. When the Inspector is satisfied that the work proposed by the applicant can be done in conformity with the provisions of this Title and after appropriate fees have been paid the Inspector shall issue the permit. Such permit shall allow for the continuous performance of the work named thereon. A permit shall automatically expire when work ceases for a period of sixty (60) days without good reasonable cause for the same as may be approved by the Inspector and shall automatically expire on completion of the work for which it is issued, provided the Inspector may, upon notice, suspend or revoke such permit for violation of the provisions of this Title.

(d) Restrictions on Issuance.

(1) No HVAC permit shall be issued to any person who is in violation of this Title until such violation has been corrected.

(2) No HVAC permit shall be issued to any person against whom an order issued by the Inspector is pending, provided this restriction may be waived by the Inspector.

(e) Data Required as Part of the Permit Application. All drawings submitted for approval shall be accompanied by sufficient data and information for the Inspector to determine if the capacity of the equipment and the performance of the equipment shall satisfy the requirements of this Title. The following data shall be submitted:

1. Submit heat loss calculation in BTU per hour for each room to be heated.
2. Include calculations for ventilation requirements.
3. Submit one (1) or more copies of complete drawings. When the heating and ventilation drawings require approval of the Department of Commerce, one (1) or more approved copies shall be submitted with the application.
4. Summation of heating and ventilating load requirement.
5. Installations shall be made to conform to approved drawings.
6. Plot plan showing the location of the condensing unit for air conditioning.
7. For solar systems, furnish:
 - a. Estimate of the amount of energy in BTUs to be delivered by the system on an annual basis, which estimate shall be based on the "F" chart analysis or another method appropriate to the system considered, and collector performance data as is determined by a recognized testing lab.
 - b. Collector tilt and azimuth angle and a solar path shading diagram for the proposed collector location indicating the shading between the hours of 9:00 a.m. and 3:00 p.m. CST for the entire year.
 - c. A plot plan showing the proposed location of the solar collector and any tree and/or structure that presently casts a shadow within twenty (20) feet of the proposed collector location.

- d. Detailed drawing showing anchorage and bearing of collector supports.
- e. Detailed drawings of all piping, pumps, blowers, wiring, storage vessels, ductwork, dampers, valves, insulation and all other material that will be required to install the system..

(f) Design Standards.

(1) The heating and ventilating design shall conform to methods and standards approved by the Inspector when not in conflict with the Wisconsin Department of Commerce.

NOTE: The Inspector will accept the method and standards recommended by the American Society of Heating, Refrigeration and Air Conditioning Engineers; National Warm Air Heating and Air Conditioning Association; Mechanical Contractors' Association of America and National Electrical Manufacturers' Association.

(2) Minimum design standards for all rooms in living quarters shall be seventy (70) degrees Fahrenheit except bathrooms, which shall be seventy-five (75) degrees Fahrenheit. The minimum outside design temperature shall be minus twenty (-20) degrees Fahrenheit.

(3) The total heat loss of a building, including the basement, shall be used in sizing heating units or electrical service for electrical space heating.

(4) The proper "U" factors shall be selected and shall reflect the additional heat loss in areas located over unheated areas.

(g) Supplemental Permits. The license holder responsible for the work shall complete any application for a supplemental permit mailed to him or her and return it to the Inspector within seven (7) days of the postmark date of the application for a supplemental permit. Failure to return the application for a supplemental permit prior to commencing work shall be deemed to be working without a permit. (Ord 08OR002)

15.10.060 Inspections.

In any new building or addition, immediately upon completion of those portions of the installation which are thereafter to be concealed or covered, the heating contractor shall notify the Inspector that said portions of the installations are ready for inspection; and it shall be unlawful for any person, firm or corporation to lath over, plaster or cover up any heating work before such work has been inspected and a rough inspection card posted. The Inspector shall have the right and authority to order the removal of all such lath, plaster or other covering which may have been placed over such work as has not been inspected. The Inspector shall make inspections within two (2) working days after notice. Final inspection on new installations is to be made upon completion of such work. Inspection of repairs, replacement or conversion work is to be made upon completion of such work. The heating contractor shall notify the Inspector as soon as the installation is complete and ready for inspection. (Ord 08OR002)

15.10.080 Liability for Damages.

This Chapter shall not affect the responsibility or liability of any party owning, operating, controlling, or installing any heating, ventilating, and air conditioning equipment for damages to persons or property caused by any defect therein, nor shall the City be held as assuming any such liability by reason of the inspection or re-inspection authorized herein or the certificate of approval issued as herein provided or by reason of the approval or disapproval of any equipment authorized herein. (Ord 08OR002)

Chapter 15.15

ELECTRICAL CODE

Sections:

15.15.010 Electrical Code

15.15.020 State Regulations Adopted

15.15.030 Permits and Inspections

15.15.010 Electrical Code.

(a) General. This Article shall be known as the "Electrical Code of the City of Viroqua" and will be referred to in this Chapter as "this Code" or "this Chapter."

(b) Purpose. The purpose of this Electrical Code is the practical safeguarding of persons and property from hazards arising from the installation and use of electricity; and to establish rules and fees for the issuance of permits, licenses, and the inspection of all electrical and communications work covered under the scope of this Chapter.

(c) Scope. This code shall apply to the installation, re-construction, alteration, extension and repair of wiring and equipment for heat, light, power, control, voice, data, CATV, fire alarm and security systems. Materials, fittings, devices, appliances, luminaries, apparatus and the like used as part of or in conjunction with said installations shall be referred to in this Code as "Equipment" or "Electrical Equipment" unless specifically stated otherwise. (Ord 08OR002)

15.15.020 State Regulations Adopted. The Department of Commerce regulations in the Wis. Adm. Code, and future amendments thereto, are adopted and by reference made a part of this Chapter with the same force and effect as though set out in full. (Ord 08OR002)

15.15.030 Permits and Inspections

(a) General. No wiring or equipment covered under the scope of this Title shall be installed, altered, re-constructed, extended or repaired without the electrician or homeowner first securing a permit from the Inspector. The applications for such permit shall be on forms provided by the Inspector and shall include such plans, specifications, and other information as are requested by the Inspector.

(b) Exception: A permit shall not be required for minor maintenance or repair of existing electrical wiring and devices.

(c) Inspections

a Rough Inspection(s). The rough inspection by the Inspector shall occur within 24 hours (during a normal working week) after notification by the contractor that the wiring and equipment is roughed in, and before such work is covered up.

b Final Inspection. The final inspection by the Inspector shall occur within 24 hours (during a normal working week) after prompt notification by the contractor that the job is completed.

c All wiring and equipment covered under the scope of this Chapter shall be inspected and approved by the Inspector before the installation or equipment is put into normal or permanent service.

d Liability for Damages This Code shall not affect the responsibility or liability of any party owning, operating, controlling or installing any electrical equipment for damages to persons or property caused by any defect therein, nor shall the City be held as assuming any such liability by reason of the inspection or re-inspection authorized herein or the certificate of approval issued as herein provided or by reason of the approval or disapproval of any equipment authorized herein. (Ord 08OR002)

Chapter 15.16PENALTIES AND VIOLATIONS

Section:

15.16.010 Penalties and Violations

15.16.010 Penalties and Violations.

(a) Any building or structure hereafter erected, enlarged, altered or repaired or any use hereafter established in violation of the provisions of the City Building Code, the City Electrical Code, Plumbing Code and Heating, Ventilating and Air Conditioning Code (all included within the definition of "this Chapter" for purposes of this Section), shall be deemed an unlawful building, structure or use. The Inspector shall promptly report all such violations to the City Attorney who shall bring an action to enjoin the erection, enlargement, alteration, repair or moving of such building or structure or the establishment of such use of buildings in violation of this Chapter or to cause such building, structure or use to be removed and may also be subject to a penalty as provided in general penalty provisions of the Code of Ordinances. Any person who fails to obtain a building permit before starting construction shall be charged double the regular rate for this late filing violation. In any such action, the fact that a permit was issued shall not constitute a defense, nor shall any error, oversight or dereliction of duty on the part of the Inspector or other City officials constitute a defense. Compliance with the provisions of this Chapter may also be enforced by injunction at the suit of the owner or owners of any real estate within the City.

(b) If an inspection reveals a noncompliance with this Title or the Uniform Dwelling Code, the Inspector shall notify the applicant and the owner, in writing, of the violation to be corrected. All cited violations shall be corrected within thirty (30) days after written notification unless an extension of time is granted pursuant to Department of Commerce regulations in the Wis. Adm. Code.

(c) If, after written notification, the violation is not corrected within thirty (30) days, a stop-work order may be served on the owner or his or her representative and a copy thereof shall be posted at the construction site. Such stop-work order shall not be removed except by written notice of the Inspector after satisfactory evidence has been supplied that the cited violation has been corrected.

(d) Each day each violation continues after the thirty (30) day written notice period has runs shall constitute a separate offense. Nothing in this Chapter shall preclude the City from maintaining any appropriate action to prevent or remove a violation of any provision of this Title or the Uniform Dwelling Code.

(e) If any construction or work governed by the provisions of this Title or the Uniform Dwelling Code is commenced prior to the issuance of a permit, double fees shall be charged.

(f) Any person aggrieved by an order or a determination of the Inspector may appeal from such order or determination to the Board of Appeals. Those procedures customarily used to effectuate an appeal to the Board of Appeals shall apply.

(d) Except as may otherwise be provided by the Statute or Ordinance, no officer, agent or employee of the City of Viroqua charged with the enforcement of this Title shall render himself or herself personally liable for any damage that may accrue to persons or property as a result of any act required or permitted in the discharge of his or her duties under this Title. Any suit brought against any officer, agent or employee of the City as a result of any act required or permitted in the discharge of his or her duties under this Title shall be defended by the legal representative of the City until the final determination of the proceedings therein. (Ord 08OR002)

Chapter 15.18ONE- AND TWO-FAMILY DWELLING CODE

Sections:

- 15.18.010 Authority
- 15.18.020 Purpose
- 15.18.030 Scope
- 15.18.040 Adoption of Wisconsin Uniform Dwelling Code
- 15.18.050 Building Inspector
- 15.18.060 Building Permit Required
- 15.18.070 Building Permit Fees; Inspection Fees
- 15.18.080 Penalties
- 15.18.090 Effective Date
- 15.18.100 Record of Inspections

15.18.010 AUTHORITY. These regulations are adopted under the authority granted by s. 101.65, Wisconsin Statutes. (Ord 08OR001)

15.18.020 PURPOSE. The purpose of this ordinance is to promote the general health, safety and welfare and to maintain required local uniformity with the administrative and technical requirements of the Wisconsin Uniform Dwelling Code. (Ord 08OR001)

15.18.030 SCOPE. A. The scope of this ordinance includes the construction and inspection of one- and two-family dwellings built since June 1, 1980.

B. Notwithstanding s. Comm 20.05, the scope also includes the construction and inspection of alterations and additions to one- and two-family dwellings built before June 1, 1980. Because such projects are not under state jurisdiction, petitions for variance and final appeals under ss. Comm 20.19 and 20.21, respectively, shall be decided by the municipal board of appeals. Petitions for variance shall be decided per s. Comm 20.19 (Intro) so that equivalency is maintained to the intent of the rule being petitioned. As the board of appeals approves petitions for variance, the building inspector is granted the power to apply the results to similar circumstances by precedent.

C. Notwithstanding s. Comm 20.05, the scope also includes the construction and inspection of detached garages serving one and two family dwellings. The building structure and any heating, electrical or plumbing systems shall comply with the Uniform Dwelling Code. Petitions for variance and appeals shall be handled as in the previous paragraph. (Ord 08OR001)

15.18.040 WISCONSIN UNIFORM DWELLING CODE ADOPTED. The Wisconsin Uniform Dwelling Code, Chs. Comm 20-25 of the Wisconsin Administrative Code, and all amendments thereto, is adopted and incorporated by reference and shall apply to all buildings within the scope of this ordinance. (Ord 08OR001)

15.18.050 BUILDING INSPECTOR. The Building Inspector shall administer and enforce this ordinance and shall be certified by the Division of Safety & Buildings, as specified by Wisconsin Statutes, Section 101.66(2), in the category of Uniform Dwelling Code Construction Inspector. Additionally, this or other assistant inspectors shall possess the certification categories of UDC HVAC, UDC Electrical, and UDC Plumbing. (Ord 08OR001)

15.18.060 BUILDING PERMIT REQUIRED. If a person (a) builds or installs a new building, within the scope of this ordinance, or (b) alters a building in excess of \$1,000.00 value in any twelve month period, or adds onto a building in excess of \$1,000.00 value in any twelve month period, the person shall first obtain a building permit for such work from the building inspector. Any structural changes or major changes to mechanical systems that involve extensions shall require permits if over the foregoing thresholds. Restoration or repair of an installation to its previous code-compliant condition as determined by the building inspector is exempted from permit requirements. (Ord 08OR001)

15.18.070 BUILDING PERMIT FEE; INSPECTION FEES. A. The building permit fees shall be as set by State statute and administrative code and shall include the UDC permit seal assigned to any new dwelling.

B. The inspection fees shall be as follows:

1. New dwellings (including manufactured dwellings):

	Footer and foundation and erosion control:	\$150.00
Rough	inspection and erosion control:	\$150.00
	Insulation, vapor barrier and erosion control:	\$150.00
Final	completion and erosion control:	\$150.00

2. Remodeling and additions (including manufactured dwellings):

Each	inspection:	\$	75.00
------	-------------	----	-------

(Ord 08OR001)

15.18.080 PENALTIES. The enforcement of this section and all other laws and ordinances relating to building shall be by means of the withholding of building permits, imposition of forfeitures and injunctive action. Forfeitures shall be not less than \$25.00 nor more than \$1,000.00 for each day of noncompliance. (Ord 08OR001)

15.18.090 EFFECTIVE DATE. This ordinance shall be effective upon passage and publication as provided by law. (Ord 08OR001)

15.18.100 RECORD OF INSPECTIONS. The building inspector(s) shall keep a log of all inspections completed. (Ord 08OR001)

Chapter 15.19

PERMIT AND INSPECTION FEES

Section:

15.19.010 Permit and Inspection fees

15.19.010 Permit and inspection Fees. The following fees shall be paid for project permits; where an inspection is either required or requested the fee for each inspection shall be \$75.00 except where other inspection fees are required under the One and Two Family Dwelling Code:

Garages and carports: - 1,000 sq. ft. or less = \$25.00 minimum plus \$1.00 per 100 sq. ft. or any part thereof in excess of 1,000 sq. ft.

Wood decks and/or masonry patios: - 400 sq. ft. or less = \$25.00 minimum plus \$1.00 per 100 sq. ft. or any part thereof in excess of 400 sq. ft.

Storage buildings: - 100 sq. ft. or less = \$25.00 plus \$1.00 per 100 sq. ft. or any part thereof in excess of 100 sq. ft.

Siding and/or roofing: - \$5,000.00 or less = \$25.00 minimum plus \$1.00 per \$1,000.00 or any part thereof in excess of \$5,000.00.

Swimming pools: = \$25.00

Fences: = \$25.00

Heating, Ventilating, Air Conditioning (HVAC): \$25.00 minimum (see following schedule).

Plumbing: \$25.00 minimum (see following schedule).

Electrical: \$25.00 minimum (see following schedule).

Heating, Ventilating, Air Conditioning (HVAC), Plumbing, and Electrical

<u>Fee Schedule:</u>	\$1,001.00 to \$2,500.00 = \$40.00
	\$2,501.00 to \$4,000.00 = \$45.00
	\$4,001.00 to \$6,000.00 = \$50.00
	\$6,001.00 to \$8,000.00 = \$55.00
\$8,001.0	0 to \$10,000.00=\$60.00
	Over \$10,000.00 = \$60.00 plus \$2.50 per thousand.

Remodeling: \$1,000.00 to \$10,000.00 = \$25.00 minimum plus \$1.00 per \$1,000.00 or any part thereof in excess of \$10,000.00.

New Residential Construction (One- and two-family) : \$100,000.00 or less: \$75.00; and add \$1.00 for each additional \$1,000.00 or part thereof over \$100,000.00.

Commercial (Greater than two-family residential and Non-residential): \$100,000.00 or less: \$100.00; and add \$2 for each additional \$1,000.00 or part thereof over \$100,000.00. (Ord 08OR007; Ord 08OR002)

Chapter 15.20FIRE CODE

Sections:

- 15.20.010 State Flammable Liquids Code adopted by reference.
- 15.20.020 Fire district – Designated.
- 15.20.030 Definitions.
- 15.20.040 Fire district – General construction specifications.
- 15.20.050 Fire district – Buildings of frame construction prohibited – Exceptions.
- 15.20.060 Fire district – Protected-type building construction.
- 15.20.070 Fire district – Storage of flammable liquids.
- 15.20.080 Fire district – Removal of old or damaged buildings.
- 15.20.090 Fire-retardant roofing.
- 15.20.100 Fire escapes – Required.
- 15.20.110 Fire escapes – Notification of owners.
- 15.20.120 Fire escapes – Owner’s duty to maintain.
- 15.20.130 Fire escapes – Violation – Penalty.
- 15.20.140 Inspection – Fire chief’s duty.
- 15.20.150 Inspection – Dangerous substances or obstructions – Orders and Citations.
- 15.20.160 Inspection – Violation – Penalty.

15.20.010 State Flammable Liquids Code adopted by reference. The State Flammable Liquids Code, as the same exists or as may be amended, is made a part of this section by reference and it shall be the duty of the building inspector to enforce the provisions thereof. (Ord. 283 §8, 1977; Ord. 161 §6, 1954).

June 2008 revision

15.20.020 Fire district – Designated. All that part of the city included within the following described territory shall be known as the fire district: beginning at the intersection of the centerline of Decker Street and the centerline of Center Avenue thence south on the centerline of Center Avenue to the centerline of South Street; thence west on the centerline of South Street to the centerline of Rock Avenue; thence north on the centerline of Rock Avenue to the south line of Terhune Street; thence west on the south line of Terhune Street to the east line of Dunlap Avenue extended; thence north on the east line of Dunlap Avenue extended to the centerline of Court Street; thence west on the centerline of Court Street to the centerline of Dunlap Avenue; thence north on the centerline of Dunlap Avenue to the centerline of Gillette Street; thence east on the centerline of Gillette Street to the centerline of Rock Avenue; thence north on the centerline of Rock Avenue to the centerline of Broadway; thence east on the centerline of Broadway to the centerline of Main Street; thence northeasterly on the centerline of Main Street to the centerline of Broadway; thence east on the centerline of Broadway to the centerline of Rusk Avenue; thence south on the centerline of Rusk Avenue to the centerline of Decker Street; thence west on the centerline of Decker Street to the point of beginning at the centerline of Center Avenue. (Ord. 161 §24, 1954).

15.20.030 Definitions. "Fire-resistive constructions," "mill construction," "ordinary construction," "frame construction" and "fire-retardant roof covering" shall have the meanings as defined in order 5100, 5101, 5102, 5103, and 5107 of the State Building Code, effective July 29, 1942. (Ord. 161 §25, 1954).

15.20.040 Fire District – General construction specifications. Every building erected, enlarged or moved within or into the fire district after April 13, 1954, shall be of fire-resistive, mill or ordinary construction, except as otherwise provided by this chapter. Enclosing walls, division walls and party walls shall be of four-hour fire-resistive walls of a construction as provided in order 5101 of the State Building Code, which is made a part of this section with respect to all buildings and structures within the fire district. (Ord. 161 §26(a), 1954).

15.20.050 Fire district – Buildings of frame construction prohibited – Exceptions. No building of frame construction shall be built within or moved into the fire district after April 13, 1954, except the following, and no such building or structure shall be located within five feet of any lot line or structure, or as required by other ordinances:

- A. Temporary one-story frame buildings for use of builders;
 - B. One-story sheds not over fifteen feet high, open on the long side and with an area not exceeding five hundred square feet. A wooden fence shall not form the back or side of such sheds;
 - C. Greenhouses not more than fifteen feet in height;
 - D. Private garages for not more than two noncommercial automobiles, if not over fifteen feet high and not more than seven hundred fifty square feet in area, having exterior walls of metal, concrete or masonry located on the same lot with a dwelling;
 - E. Frame dwellings designed for single-family occupancy.
- Ord. 161 §26(b), 1954).

15.20.060 Fire district – Protected-type building construction. A. Certain protected-type buildings may be constructed within the fire district as follows:

1. Accessory buildings, to be used for storage or other purposes incidental to commercial or industrial use of the premises, may be of steel frame construction with enclosing walls and division walls of incombustible materials, such as, but not limited to, steel sheathing, cement asbestos sheathing, concrete, brick or tile, with roof covering of type b underwriters' classification or better, and not exceeding fifteen feet in height.

2. Buildings to be used for commercial or light industrial purposes, but not primarily as accessory buildings, may be of steel frame construction with enclosing walls and division walls of incombustible material, such as, but not limited to, steel sheathing, cement asbestos sheathing, concrete, brick or tile, with roof covering of type b underwriters' classification, or better, not exceeding fifteen feet in height, and with the further qualification that enclosing walls and ceilings shall be insulated with an incombustible material having inside lining of incombustible material.

B. Buildings constructed in accordance with the provisions of this section shall not be closer than ten feet from any lot line, street line or adjacent building, or as required by other ordinances, and shall in all respects, except as provided in this chapter comply with all other provisions of this chapter. (Ord. 177 §1, 1955; Ord. 161 §26(c), 1954).

15.20.070 Fire district—Storage of flammable liquids. The storage of flammable liquids within the fire district shall conform to the State Flammable Liquids Code issued by the State Industrial Commission. (Ord. 161 §27, 1954).

15.20.080 Fire district—Removal of old or damaged buildings. Any existing frame building within the fire limits which may be damaged by fire, or which has deteriorated to an amount greater than one-half of its assessed value, exclusive of the foundation, shall not be repaired or rebuilt but shall be ordered removed under the provisions of Section 66.05(5) of the Wisconsin Statutes by the building inspector. (Ord. 161 §28, 1954).

15.20.090 Fire-retardant roofing. A. Every roof constructed within the fire district after April 13, 1954, including buildings listed in Sections 15.20.040 through 15.20.060 shall be covered with a roofing having a fire-resistive rating equivalent to class B or better of the Underwriters' Laboratories, Inc. classification.

B. No roofing on an existing roof shall be renewed or repaired to a greater extent than one-tenth of the roof surface with a roofing having a fire-resistive rating less than class C or better of the Underwriters' Laboratories, Inc. classification. (Ord. 171 §10, 1955; Ord. 161 §29, 1954).

15.20.100 Fire escapes—Required. All buildings, except private residences, already erected or that may be erected after February 28, 1921, of three or more stories in height, shall be provided with good and sufficient fire escapes. (Ord. 51 §1, 1921).

15.20.110 Fire escapes—Notification of owners. Notice in writing shall be served by the chief of the fire department upon the owner or owners of such building or buildings, by leaving at their place or business or residence a notice specifying the number, kind, location and construction of the fire escape or means of egress required under Section 15.20.100 and shall direct that the work shall be done not later than sixty days from the filing of the notice. (Ord. 51 §2, 1921).

15.20.120 Fire escapes —Owner’s duty to maintain . The owner or owners of any building or buildings upon which a fire escape is erected shall keep the same in good repair. (Ord. 51 §3, 1921).

15.20.130 Fire escapes—Violation—Penalty. Any owner, agent or lessee of any building violating any of the provisions of Sections 15.20.100 through 15.20.120, or failing to comply with the terms thereof, shall be fined not less than five dollars nor more than twenty-five dollars for each and every day the building may be unfurnished with such fire escapes or proper means of egress after the expiration of the sixty days' notice required. (Ord. 51 §4, 1921).

15.20.140 Inspection—Fire chief’s duty.

A. It shall be the duty of the chief of the fire department to inspect or cause to be inspected by fire department officers or members, all buildings, premises and public thoroughfares, except the interiors of private dwellings, for the purpose of ascertaining and causing to be corrected any conditions liable to cause fire or any violations of the provisions or intent of any ordinance of the city affecting the fire hazard.

B. Such inspections shall be conducted at least once per calendar year provided the interval between those inspections does not exceed 15 months. (Ord 09OR003; Ord 08OR006; Ord. 47 §1(part), 1921).

15.20.150 Inspection--Dangerous substances or obstructions. Orders and Citations.

A. Whenever any officer or member finds in any building, or upon any premises or other place, combustible or explosive matter or a dangerous accumulation of rubbish or unnecessary accumulation of wastepaper, boxes, shavings or any other highly inflammable materials especially liable to fire, and which is so situated as to endanger property; or finds obstructions to or on fire escapes, stairs, passageways, doors or windows liable to interfere with the operation of the fire department or egress of occupants in case of fire, such officer or member shall order the same to be removed or remedied, and such order shall forthwith be complied with by the owner or occupant of such premises or buildings.

B. Any owner or occupant failing to comply with such order shall be liable to a penalty as stated in Section 15.20.160.

C. The service of any such order shall be made upon the occupant of the premises to whom it is directed by either delivering a true copy of same to such occupant personally or by delivering the same to and leaving it with any person in charge of the premises. (Ord. 47 § 1 (part), 1921).

D. The Chief of the Fire Department, and any firefighter to whom the Chief delegates authority, may issue a citation for a failure to comply with such order. (Ord 08OR006)

15.20.160 Inspection – Violation – Penalty. Any person who fails to comply with such order shall, upon conviction, forfeit not less than twenty-five dollars (\$25.00) nor more than two-hundred fifty dollars (\$250.00) for the first offense, and not less than seventy-five dollars (\$75.00) nor more than five-hundred dollars (\$500.00) for a second and subsequent offense, and upon failure to pay such forfeiture and costs shall be imprisoned in the County jail until such forfeiture and costs are paid, not exceeding 30 days. Each day a violation continues shall constitute a separate offense. (Ord 08OR006; Ord. 47 §2, 1921).

D. The Chief of the Fire Department, and any firefighter to whom the Chief delegates authority, may issue a citation for a failure to comply with such order. (Ord 08OR006)

15.20.160 Inspection – Violation – Penalty. Any person who fails to comply with such order shall, upon conviction, forfeit not less than twenty-five dollars (\$25.00) nor more than two-hundred fifty dollars (\$250.00) for the first offense, and not less than seventy-five dollars (\$75.00) nor more than five-hundred dollars (\$500.00) for a second and subsequent offense, and upon failure to pay such forfeiture and costs shall be imprisoned in the County jail until such forfeiture and costs are paid, not exceeding 30 days. Each day a violation continues shall constitute a separate offense. (Ord 08OR006; Ord. 47 §2, 1921).

Title 16

SUBDIVISIONS

Chapters:

- 16.04 General Provisions
- 16.08 Definitions
- 16.12 Design Requirements
- 16.14 Land Development Improvements
- 16.16 Plats
- 16.20 Penalty

Chapter 16.04

GENERAL PROVISIONS

Sections:

- 16.04.010 Survey and plat required when - Restrictive provisions controlling
- 16.04.020 Plan determination
- 16.04.030 Variations
- 16.04.040 Preparation of recordable plat required

16.04.010 Survey and plat required when - Restrictive provisions controlling.

A. Any division of land within the city or its extraterritorial subdivision approval jurisdiction which shall result in a subdivision as defined in Section 16.08.010, except cemetery plats and assessor's plats, shall be surveyed and the plat or map approved as required by this title and as required by Chapter 236 of the Wisconsin Statutes.

B. Any provision of this title more stringent or restrictive in character than the Wisconsin Statutes or any other ordinance of the city shall be controlling (Ord. 256 s. 2, 1974).

16.04.020 Plan determination. The council will use soil maps, natural drainage patterns and existing topography in determining the acceptability of a proposed subdivision plan. Guidelines and specifications in "Minimizing Erosion in Urbanizing Areas" will be used in council determinations. (Ord. 256, s.9(A), 1974).

16.04.030 Variations. The Council may approve variations from the regulations of this title in specific cases which do not affect the general plan or the spirit of this title. Any such variation shall be recorded in writing with the city clerk with the reasons therefor. (Ord. 256 §9(B), 1974).

16.04.040 Preparation of recordable plat required. Surveyors or engineers laying out a subdivision as defined in Section 16.08.010 without preparing a recordable plat shall be subject to the penalties provided in Chapter 16.20. (Ord. 256 §9(c), 1974).

Chapter 16.08

DEFINITIONS

Sections:

16.08.010 Subdivision.

16.08.010 Subdivision. For the purpose of this title, "Subdivision" is the division of a lot, parcel, or tract of land by the owner thereof or his agent for the purposes of sale or of building development. (Ord. 369, §1, 1985; Ord. 256, §1, 1974).

Chapter 16.12

DESIGN REQUIREMENTS

Sections:

16.12.010 Streets and roads – Grades.
16.12.020 Streets and roads – Public improvements.
16.12.030 Existing streets and roads – Continuation.
16.12.040 Major streets – width.
16.12.050 Dead-end streets.
16.12.060 Streets – Division requirements.
16.12.070 Street connections and extensions.
16.12.080 Street curves.
16.12.090 Street intersections near railroad rights-of-way.
16.12.100 Street names.
16.12.110 Streets and roads – Developer’s responsibilities.
16.12.120 Alleys and easements.
16.12.130 Lots.
16.12.140 Public use dedications.
16.12.150 Drainage – Cutting and filling.
16.12.160 Sewer and water – Facility standards – Public systems preferable.
16.12.170 Sewer and water – Standards for unplatted land development.

16.12.010 Streets and roads – Grades. A. Consideration shall be given to topography, with a view to securing safe and easy grades and avoiding unsightly and expensive cuts and fills. Where grades are steep, it is desirable to cut diagonally across the contour lines. The owner shall furnish profiles of all streets and alleys in the proposed subdivision, horizontal scale forty feet to the inch and vertical scale four feet to the inch. Grades shall not exceed ten percent and shall not be less than thirty-two hundredths percent.

B. The owner shall furnish and submit a grading plan with the final plat showing the grades before the final plat is approved and before the owner commences construction of any buildings on the premises. The grading of all streets and alleys shall be completed to the approved grades by the owner, and all necessary drainage structures, except storm sewers, shall be in place or a surety bond covering compliance with this requirement shall be furnished by the owner. The grades are to be so laid that sanitary sewers and storm sewers can connect with the existing or proposed extension of existing sewers by gravity flow wherever practicable. The Council shall have the right to require an adequate sand lift where deemed necessary in the opinion of the city's engineer.

C. In developing subdivision plans, the developer is urged to make use of the book "Minimizing Erosion in Urbanizing Areas" published by the U.S. Soil Conservation Service, a copy of which is on file in the office of the city clerk. (Ord. 256 §6(A)(1), 1974).

16.12.020 Streets and roads – Public Improvements. The Council may require the subdivider to make and install any additional public improvements reasonably necessary, or that he execute a surety bond to insure that he will make those improvements within a reasonable time, as a prerequisite to approval of the plat. (Ord. 256 §6(A)(2), 1974).

16.12.030 Existing streets and roads – Continuation. Provisions shall be made in the plat for the suitable continuation of the present existing roads and street in adjoining plats or in adjoining unplatted lands. In case straight continuations are not practicable, the continuations should be accomplished by use of suitable curves in order to avoid street jogs or off-center intersections. (Ord. 256 §6(A)(3), 1974).

16.12.040 Major streets – Width. All major streets shall be platted to a width of not less than sixty feet. (Ord. 256 §6(A)(4), 1974).

16.12.050 Dead-end Streets. At the ends of all dead-end streets, there shall be provided a turnaround not less than ninety feet nor more than one hundred feet in diameter and the roadway shall not be less than seventy feet nor more than eighty feet in diameter. Center islands shall be prohibited therein. Where necessary to give access or to permit a satisfactory subdivision of adjoining land, streets shall run through to the boundary of the property, and the resulting dead-end streets may be approved without a permanently platted turnaround. (Ord. 256 §6(A)(5), 1974).

16.12.060 Streets – Division requirements. Streets shall be platted a sufficient distance apart to allow two tiers of lots, but not more than two. Where land is being subdivided into parcels larger than will eventually be required for normal building purposes, such parcels shall be divided so as to allow for the proper extension of streets at the time of resubdivision. (Ord. 256 §6(A)(6), 1974).

16.12.170 Street connections and extensions. Adequate street connections and extensions shall be provided to insure free access to adjoining subdivisions and lands which may be subdivided later. (Ord. 256 §6(A)(7), 1974.)

16.12.080 Street curves. Where practicable, both horizontal and vertical curves in streets shall be designed so as to provide a clear view ahead for drivers of motor vehicles of at least eight hundred feet on a major street and four hundred feet on a minor street. A change of direction of a street shall be effected by means of a curve rather than an abrupt angle. Long sweeping curves are preferred to sharp curves. (Ord. 256 §6(A)(8), 1974).

16.12.090 Street intersections near railroad rights-of-way. The intersection of a street parallel to the railroad right-of-way with a street which crosses the railroad shall be at a distance of at least one hundred fifty feet from the railroad right-of-way and, where a future grade separation may be involved, at a sufficient distance to insure safe traffic control. Streets crossing railroads where future grade separations are anticipated may be required to have extra width at the approaches to the railroad right-of-way sufficient to accommodate the change of grade. (Ord. 256 §(A)(9), 1974).

16.12.100 Street names. New street names shall not duplicate the names of existing streets; provided, however, that streets that are obviously in alignment with others already existing shall bear the names of the existing streets. (Ord. 251 §6(A)(10), 1974).

16.12.110 Streets and roads – Developer’s responsibilities. Road and street requirements in both platted and unplatted developments shall be as follows:

A. The developer shall dedicate a sixty-foot right-of-way to the public by highway deed or similar instrument.

B. The developer shall place a right-of-way on a properly finished grade and shall pay for culverts and headers for culverts where needed. Installation shall be furnished by the city.

C. All rough grading, completion of the sub-grade, and gravel base according to City policy as determined by the Public Works Committee, shall be done by the developer. (Ord. 376, §2, 1985; Ord. 256 §7, 1947; Ord. 457, 1995).

16.12.120 Alleys and easements. A. Alleys not less than twenty feet in width shall be provided in the rear of all lots intended for business use.

B. Alleys in the rear of lots intended for residential use are prohibited, except in rear of lots fronting upon major highways. Where permitted, such alleys shall not be less than twenty feet in width.

C. Where alleys are not provided, utility easements of not less than five feet in width shall be provided on each side of all rear lot lines and along side lines of lots where necessary. Easements shall be continuous and in alignment from block where practicable. (Ord. 256 §6(B), 1974).

16.12.130 Lots. A. The minimum area of each lot shall be as required by appropriate state agencies but in any event no less than one thousand square feet, nor shall any lot be less than seventy feet in width at the building setback line. The building setback shall be twenty-five feet from the front lot line.

B. All reversed corner lots which front on a different street than the other lots on the same side of the block shall have extra width sufficient to permit the maintenance of the building line of the lots in the rear along the street side of such reversed corner lots.

C. Reversed corner lots in residence districts shall be avoided where practicable.

D. Lots fronting on two approximately parallel streets shall be avoided where practicable.

E. Every lot shall front upon a public street.

F. Side lot lines shall be at right angles to straight streets and radial to curved streets where practicable.

G. The Council may waive the placing of monuments for a reasonable time on condition that the subdivider execute a surety bond to insure that the subdivider will place the monuments within the time required. (Ord. 256, 1974).

16.12.140 Public use dedications. A. Purpose. The requirements of this section are established to ensure that adequate parks, open spaces and sites for other public uses are properly located and preserved as the City grows and that the cost of providing the park and recreation sites and facilities necessary to serve the additional people brought into the community by land development may be equitably apportioned on the basis of the additional needs created by the development. The requirements shall apply to the lands proposed for all residential development.

B. Design. In the design of a subdivision, land division, planned development or development project, provision shall be made for suitable sites of adequate area for schools, parks, playgrounds, open spaces, drainage -ways and other public purposes. Such sites as are shown on any Official Map, Master Plan or Parks and Open Space Plan shall be made a part of the design. Consideration shall be given to the preservation of scenic and historic sites, stands of trees, marshes, lakes, ponds, streams, watercourses, watersheds and ravines, and woodlands, prairie and wetland plant and animal communities.

C. Dedication. The development shall dedicate adequate land for the park, recreation and open space needs of the development in accordance with standards outlined in any Plan for Parks and Open Space. The developer shall dedicate sufficient land area to provide adequate park, playground, recreation and open space to meet the needs to be created by and to be provided for the subdivision, land division, group housing project, or planned community development project. At least 1,450 square feet of land shall be dedicated for each proposed residential dwelling unit.

E. Fee in lieu of dedication. The City may require the developer to pay a fee in lieu of making the required land dedication. The fee may be the equivalent of a real estate tax that would be imposed on the amount of park space that would be required based upon the number of residential units, if such space were developed to the same extent as the rest of the development, as estimated by the City assessor. The City may require that the developer satisfy the requirements of this section by combining land dedication and a fee payment, adjusting any fee by the amount of land dedicated for park purposes. Payment shall be in a lump sum prior to the recording or approval of a final plat or certified survey map or prior to the issuance of any building permit for a development where no plat or certified survey map is involved.

F. Use of fee. The City shall place the fees collected pursuant to the provisions of this section as follows: 50% in the fund for acquisition of public land, 50% for park development.

G. Development of area. When parkland is dedicated, the developer is required to bring the dedicated land to the contours established in the approved street and utility plans, with a minimum of 4" of quality topsoil, seeded as specified by the City, fertilized with 16-6-6 at the rate of 7 pounds per 1000 square feet and mulched as specified in the Standard Specifications for Road and Bridge Construction Sections 627 and 629. Topsoil furnished for the park site shall consist of the natural loam, sandy loam, silt loam, silty clay loam or clay loam humus-bearing soils adapted to the sustenance of plant life, and such top soil shall be neither excessively acid nor alkaline. Fine grading and seeding must occur within one year following issuance of the first building permit within the subdivision unless otherwise permitted by the City. (Ord. 434, 1992).

16.12.150 Drainage – Cutting and filling. A. No streets, alleys or public thoroughfares shall be permitted in or upon any waterway, ditch or any natural drainage course, whether dry or flowing, unless it is a planned part of the stormwater removal system and is adequately constructed for such purpose.

B. Adequate easements, as required in the judgment of the Council, shall be established and provided for draining of all surface or underground waters.

C. Where cutting and/or filling is necessary the following requirements shall apply:

1. All cut sections shall have a slope not deeper than 2 to 1. All fill sections shall have a slope not steeper than 3 to 1. All such areas shall be provided with suitable soil material and shall be seeded with grass or other appropriate vegetation so as to reduce erosion and sedimentation, and shall be maintained until such grass or vegetation is established.

2. Fertilizing, seeding and mulching shall be used following the specifications as shown in the book "Minimizing Erosion in Urbanizing Areas" by the U.S. Soil Conservation Service, which is on file in the city hall.

D. No excavating, earth moving or road construction shall be commenced before the preliminary plat has been approved by the Council. Failure to comply with this subsection shall constitute a total violation of this title. (Ord. 256, 1974).

16.12.160 Sewer and water - Facility standards - Public systems preferable.

A. To have City approval, all plats under Chapter 236 of the Wisconsin Statutes shall provide sewer and water facilities in accordance with the State Board of Health requirements.

B. Individual sewer and water systems shall be eliminated insofar as possible and public systems will be installed whenever possible. (Ord. 256 S. 6(F), 1974)

16.12.170 Sewer and water - Standards for unplatted land development. All unplatted land development shall also satisfy all State Board of Health requirements with respect to sewer and water. (Ord. 256 S. 8, 1974).

Chapter 16.14LAND DEVELOPMENT IMPROVEMENTSSections:

- 16.14.010 Required improvements
- 16.14.020 Improvements Generally; "Developer's Agreement"; Bond; As-built plat; Qualification of Contractors
- 16.14.030 Water facilities
- 16.14.040 Storm and Sanitary Sewers
- 16.14.050 Street grading
- 16.14.060 Street surfacing
- 16.14.070 Monuments
- 16.14.080 Street lights
- 16.14.090 Street name signs
- 16.14.100 Preservation of natural features
- 16.14.110 Unsuitable land
- 16.14.120 Inspections

16.14.010 Required improvements . All land development within a subdivision shall comply with the requirements of this chapter.

16.14.020 Improvements Generally; "Developer's Agreement"; Bond; As-built plat; Qualifications of Contractors. (A) The subdivider shall install street and utility improvements and other improvements indicated on the plat or other plan for development as provided in this chapter. The subdivider shall at the time a plat or plan is submitted for City approval sign the City's "Development Agreement" pertaining to such improvements. If such improvements are not installed as required at the time the final plat is submitted for approval, the subdivider shall, before final approval is granted by the City, furnish a bond to ensure installation, meeting the approval of legal counsel, or furnish a certified check in an amount equal to the estimate of cost prepared by the director of public works. Such bond or check shall incorporate a provision guaranteeing that such improvements will be completed by the subdivider or the subdivider's contractor as provided in the Developer's Agreement, or not later than one year from the date of recording of the plat, or not later than 120 days after storm sewer, sanitary sewer and water utility installations have been completed in those cases where the City and the subdivider have entered into an agreement for such work to be done by the City, which ever shall first occur. Such bond or check shall also incorporate a provision guaranteeing payment of all obligations to subcontractors and material suppliers for work on the subdivision. Upon completion of the required improvements, a detailed as - built survey plat shall be furnished to the City showing the location, dimensions, construction materials, and other information reasonably required by the director of public works, and such bond or check shall also incorporate a guarantee that such as- built plat shall be completed and furnished.

(B) The qualifications of contractors and subcontractors who are to be engaged in the installation of improvements in street right-of-ways must first be approved by the director of public works.

16.14.030 Water facilities . The subdivider shall install adequate water facilities according to the specifications, and subject to inspection, of the director of public works and the City water utility. The costs of any engineering and inspection shall be paid by the subdivider. All water facility installations shall be in accordance with any rules and regulations of the Public Service Commission, the Department of Natural Resources, and any other regulatory body. Private wells will only be permitted when the subdivision is not served, nor will it likely be served in the near future, by the City water utility, and then only in compliance with applicable statutes, ordinances, rules and regulations. (See 16.12.160 & 16.12.170)

16.14.040 Storm and Sanitary Sewers . The subdivider shall install adequate storm and sanitary sewers, according to the specifications, and subject to inspection, of the director of public works and the City sewer utility. The costs of any engineering and inspection shall be paid by the subdivider. All storm and sanitary sewer installations shall be in accordance with any rules and regulations of the Department of Natural Resources, and any other regulatory body. Private sewage disposal systems will only be permitted when the subdivision is not served, nor will it likely be served in the near future, by the City sewer utility, and then only in compliance with applicable statutes, ordinances, rules and regulations. (See 16.12.160 & 16.12.170)

16.14.050 Street grading . The subdivider shall furnish drawings that show the existing and proposed grades of streets shown on the plat and, after completion of engineering work on the streets and approval of the street grades by the director of public works and the plan commission, the subdivider shall grade or cause to be graded the full width of the right-of-way of the streets to be dedicated. The bed for the roadways in the street right-of-ways shall be graded to subgrade. The cost of engineering and inspection shall be borne by the subdivider. The work shall have the approval of the director of public works prior to the time the plan commission recommends approval of the final plat.

16.14.060 Street surfacing . After sewer and water utilities have been installed by the subdivider and approved by the City, the subdivider shall construct curbs and gutters when required by the City, and storm sewer inlets and leads as directed by the director of public works, and shall surface or cause to be surfaced roadways to the width required by the director of public works. The surfacing shall, if not otherwise specified in the "Developer's Agreement", consist of not less than six inches of crushed gravel or sand lift, as determined by the director of public works, and surfaced with bituminous concrete or portland cement concrete, or a comparable all-weather surfacing meeting standards established by the director of public works. Such work shall be done in accordance with plans prepared by the subdivider's engineer subject to the reasonable

approval of the director of public works. The work shall be subject to inspection of the director of public works, and any engineering and inspection costs shall be borne by the subdivider.

16.14.070 Monuments . The subdivider shall place permanent reference monuments in the subdivision as required in Chapter 236 of the Wisconsin Statutes. All monuments shall be properly set in the ground and approved by the director of public works prior to the time the plan commission considers approval of the final plat.

16.14.080 Street lights . Street lights shall be installed to illuminate all principal improved highways and roads at locations determined by the director of public works to facilitate public travel, and in accordance with design and specification standards approved by the director of public works.

16.14.090 Street name signs . Street name signs shall be erected at each street intersection in accordance with the established policy of the City and in accordance with design and specification standards approved by the director of public works.

16.14.100 Preservation of natural features. Due regard shall be given to the preservation of natural features such as large trees, watercourses and dry runs, historical and similar features.

16.14.110 Unsuitable land. No land shall be subdivided for residential use that is determined by the plan commission, after investigation and report by the director of public works, to be unsuitable for such use by reason of flooding or adverse drainage, adverse earth or rock formation or topography, or because of any other feature likely to be harmful to the health, safety, or welfare of residents in the proposed subdivision.

16.14.120 Inspections. The subdivider, prior to commencing any work within the subdivision, shall make arrangements with the City Engineer to provide for adequate interim inspections of all improvements and installations at the subdivider's cost and expense. The City Engineer shall inspect and approve all completed work prior to approval of the final plat, Council acceptance of development or release of sureties.

Chapter 16.16

PLATS

Sections:

- 16.16.010 Preliminary plats - Submittal - Required information.
 16.16.020 Preliminary plat - Action by Council.
 16.16.030 Final Plat.

16.16.010 Preliminary plats - Submittal - Required information. The owner of any lands seeking to subdivide the same shall, before submitting a preliminary plat to the City, present proposed plans to the Public Works Committee and to the Parks and Recreation Committee for the committees' consideration and recommendation. Thereafter the owner shall submit to the City Clerk a preliminary plat of such land, together with a list of the approvals required, to enable the City Clerk to forward copies for approval or objection to the agencies specified by Chapter 236 of the Wisconsin Statutes. The preliminary plat shall be legibly drawn at one hundred feet to the inch or larger scale, and shall show the following: (Ord. 457, 1995); (Ord. 512, 2000)

- A. The title under which the proposed plat is to be recorded, which title shall not duplicate or be deceptively similar to the name of any plat previously recorded in the county;
- B. The names and addresses of the owner, subdivider and engineer or surveyor;
- C. The exact location by distance and bearings of the exterior boundaries of the land to be platted with reference to a corner or corners established in the U.S. Public Land Survey;
- D. All municipal boundary lines within or adjacent to the proposed subdivision;
- E. The names of all adjoining plats;
- F. The locations, names and width of all existing streets, alleys, easements and rights-of-way, and the location of all property lines, section lines, and quarter section lines within the proposed plat or within two hundred feet thereof;
- G. The location, arrangement and width of proposed streets, alleys and easements, and the location of proposed building lines;
- H. All lots with dimensions;
- I. Location and area of property proposed to be dedicated to the public use and for other purposes, and to which governmental unit the property will be dedicated;
- J. The location of all permanent buildings and structures, and the size and location of all existing sewers and water mains, if any, within the proposed plat or within two hundred feet thereof;
- K. Ground elevations and contours to be shown as follows:
 - 1. For lands that slope less than approximately two percent, show spot elevations at all breaks in grade, along all drainage channels of swales, and at selected points not more than one hundred feet apart in all directions,

2. For lands that slope more than approximately two percent, show contours with an interval of not more than five feet where the ground slope is regular and such information is sufficient for planning purposes, or show contours with an interval of not more than two feet where necessary because of irregular land or need for more detailed data;

L. Approximate boundaries of areas subject to floodwater or stormwater overflow, areas covered by water and approximate boundaries of wooded areas;

M. Approximate grades of streets and alleys where the proposed grade will exceed four percent;

N. A brief description of proposed restrictive covenants or building restrictions, if any;

O. The date, scale and north point. (Ord. 256 §3, 1974).

16.16.020 Preliminary plat - Action by Council.

A. Within 30 days of the filing of a preliminary plat, the common council shall either approve or disapprove such plat. Approval of a preliminary plat shall be noted in writing on the face of the preliminary plat and furnished to the owner.

B. In the event that the preliminary plat is disapproved, the reasons for such disapproval shall be stated in writing, in duplicate, one copy of which shall be delivered to the owner and the other copy retained for filing.

C. Approval of the preliminary plat shall be considered as merely a general approval of the layout submitted, and shall not commit the Council to approval of the final plat. (Ord. 256 §4, 1974).

16.16.030 Final Plat.

A. All requirements of Chapter 236 of the Wisconsin Statutes shall be met before the final plat is entitled to record.

B. All requirements of this title must be fully met before the final plat is entitled to record. (Ord. 256 §5, 1974).

Chapter 16.20

PENALTY

Section:

16.20.010 Violations, Penalties, Enforcement

Section 16.20.010 Violations, Penalties, Enforcement. A. Any person who violates or fails to comply with any provision of Title 16 shall be required to forfeit not less than \$100 nor more than \$500, and in default of payment of such forfeiture and the costs of prosecution shall be imprisoned in the County jail until such forfeiture and costs are paid, but not exceeding 30 days.

B. Each day a violation continues constitutes a separate offense.

C. A violation of this Title constitutes a public nuisance, and may be enjoined by the City.

D. No building permit may be issued for any property within a proposed subdivision before the plat has been approved by the City and is recorded in the office of the register of deeds.

Title 17

Zoning

Chapters:

- 17.04 General Provisions
- 17.08 Zoning Districts
- 17.09 Planned Unit Development
- 17.12 Administration
- 17.16 Definitions
- 17.40 Signs
- 17.42 Airport Area Zoning
- 17.44 Historic Preservation

Chapter 17.04

GENERAL PROVISIONS

Sections:

- 17.04.010 Title
- 17.04.020 Compliance
- 17.04.030 Conflicting Provisions Repealed
- 17.04.040 Purpose and Intent
- 17.04.050 Authority
- 17.04.060 Interpretation, Greater Restrictions
- 17.04.070 Warning and Disclaimer of Liability
- 17.04.080 Restrictions and Exceptions Applicable to All Districts
- 17.04.090 Conditional Uses
- 17.04.100 Nonconforming Premises and Uses
- 17.04.110 Temporary Building Permit Moratorium
- 17.04.120 Fences
- 17.04.130 Swimming Pools

17.04.010 Title. This ordinance shall be known and may be cited and referred to as the "zoning ordinance of the City of Viroqua, Wisconsin."

17.04.020 Compliance. The use or development of any land, a change or alteration in the use of any land, and the use, change of use, alteration, construction, reconstruction, remodeling or expansion of any structure within the areas regulated by this ordinance shall be in compliance with the terms of this ordinance, and other applicable local, state, and federal regulations.

17.04.030 Conflicting Provisions Repealed. All ordinances or parts or sections of ordinances in conflict herewith are hereby repealed in their entirety.

17.04.040 Purpose and Intent. The purpose of this ordinance is to promote the health, safety, morals, prosperity, aesthetics, comfort, and general welfare of this community. It is the general intent of this ordinance to regulate and restrict the use of all structures and lands; regulate and restrict lot coverage, population distribution and density, and the size and location of all structures so as to lessen congestion in and promote the safety and efficiency of the streets and highways; secure safety from fire, panic and other dangers, provide adequate light, air, sanitation and drainage; prevent overcrowding; avoid undue population concentration; facilitate

the adequate provision of public facilities and utilities; stabilize and protect property values; further the appropriate use of land and conservation of natural resources; preserve and promote the beauty of the community; and implement the community's comprehensive plan or plan components.

17.04.050 Authority. These regulations are adopted pursuant to authorization contained in Section 62.23 of the Wisconsin Statutes as amended and said Section of the Wisconsin Statutes is hereby adopted.

17.04.060 Interpretation, Greater Restrictions and Abrogation. Where any other city ordinance is more restrictive than the provisions contained in this ordinance, that ordinance shall continue in full force and effect to the extent of the greater restrictions, but not otherwise. This ordinance is not intended to repeal, abrogate, or impair any existing easements, covenants, or private deed restrictions. However, where this ordinance imposes great restriction, the provision of this ordinance shall prevail.

17.04.070 Warning and Disclaimer of Liability. The degree of protection intended to be provided by this chapter is considered reasonable for regulatory purposes. This ordinance does not imply that compliance will result in freedom from damages nor shall this ordinance create a liability on the part of or a cause of action against the City of Viroqua or any officer or employee for any damage that may result from reliance on this ordinance.

17.04.080 Restrictions and Exceptions Applicable to All Districts. A. No lot area shall be so reduced that the yards and open spaces shall be smaller than is required by these regulations, nor shall the density of population be increased in any manner except in conformity with the area regulations established for the district in which a building or premises is located.

No part of a yard or other open space provided about any building for the purpose of complying with the provisions of this ordinance shall be included as a part of a yard or other open space required for another building.

B. Every building erected, converted, enlarged or structurally altered shall be located on a lot, and in no case shall there be more than one main building on one lot, except for buildings which are an adjunct or accessory use when the lot is used for eleemosynary purposes, and then upon such conditions as the Council may impose as for other conditional uses. (Ord. 423, 1990).

C. No building shall be erected, converted, enlarged, or structurally altered until served with municipal water and sewer.

D. Nothing contained in this section shall require any change in the plans, construction, size or designated use of any building or part thereof for which a building permit has been issued, and the construction of which has been started within six months from the date of such permit.

E. Structures permitted above height limit. The building height limitations of this ordinance shall be modified as follows:

1. Chimneys, cooling towers, elevator bulkheads, fire towers, monuments, penthouses, stacks, stage towers, or scenery lofts, tanks, water towers, silos, spires and radio or television towers, or necessary mechanical appurtenances may be erected to a height in accordance with existing or hereafter adopted ordinances of the City of Viroqua, Wisconsin.

2. Public, semi-public or public service building, hospitals, sanitariums or schools, when permitted in a district, may be erected to a height not exceeding sixty feet, and churches and temples, when permitted in a district may be erected to height not exceeding seventy-five feet if the building is set back from each property line at least two feet for each foot of additional building height above the height limit otherwise provided in the district which the building is built.

F. Exceptions to yard and setback requirements.

1. Every part of a required yard shall be open to the sky unobstructed with any building or structure, except for a permitted accessory building in a rear yard, and except for the ordinary projections of skylights, sills, belt courses, cornices and ornamental features projecting not to exceed thirty-six inches and the usual steps on unenclosed porches not to exceed the ten feet in depth.

2. An accessory building (such as a garage, car port, storage shed, etc.) may be located in a rear or side yard provided it does not occupy more than 30 percent of the area of the required rear yard, is not more than 15 feet high and is at least 4 feet from any lot line (at least 10 feet from any alley if the accessory building has an entrance on the alley); measurement shall be made from the point on the structure closest to the lot line, provided, that for any structure with a roof having not more than a 2 foot overhang, measurement shall be made from the structure's wall nearest the lot line.

3. No structure or object of natural growth shall be maintained or allowed to grow higher than 36 inches above the level of the lowest street, curb, or sidewalk, or land surface if no curb or sidewalk exists, within 20 feet of any corner so as to interfere with traffic visibility.

G. Buildings to have access. Every main building hereafter erected or moved shall be on a lot abutting a public street, provided: that the Council, on favorable recommendation of the Plan Commission, may permit, upon such conditions as the Council may set, a building on a lot not abutting a public street if the owner has secured comparable access, such as by permanent easements which provide public access and extension of applicable utility service. A building shall be so situated on a lot as to provide safety and convenient access for servicing, fire protection and any required off-street parking.

H. Off-street Parking Areas Required.

1. General provisions. In all districts space for parking shall be provided.

2. Development and maintenance of parking lots. Every parcel of land hereafter used as a public or private parking area, shall be developed and maintained in accordance with the following requirements:

a. No vehicle parking shall be allowed within the required front or side yard of any permitted use in any "R" District except in driveways or garages. The Board of Appeals may approve site plans which vary from this concept.

b. Any lighting used to illuminate any off-street parking area including any commercial parking lot, shall be so arranged as to reflect the light away from adjoining premises in any "R" District.

c. Any parking lot containing ten or more spaces shall be hard surfaced with bituminous or Portland Cement Concrete and shall be permanently screened with natural plant material, screening fences or walls. Only those side of a parking lot facing upon public streets or adjoining to or upon an "R" District are required to be screened.

d. A parking space shall be nine feet wide and twenty feet long, plus drive and turning space.

I. Signs

All conditions referring to signs in the City of Viroqua will be found in the Viroqua Sign Ordinance.

J. Mobile Homes shall be located in Mobile Home Parks unless approved by the City Council.

17.04.090 Conditional Uses.

A. Intent. It is the intent that some special uses be allowed as permitted uses if they are generally compatible with the land use intent of the district and if such special uses meets or can be adjusted to meet necessary conditions or performance standards which would make such special uses basically compatible with the permitted uses in the district. Conditional Uses may be allowed in any district providing for them with re-zoning land. The intent of Conditional Uses is to allow certain borderline uses in a district subject to performance standards or conditions without which the use would not be permissible within that particular district. The provision is intended to provide flexibility in the ordinance and give the municipality an opportunity to review and regulate specialized or unique uses, and to decide if borderline uses are conducive to being located in a specific proposed location rather than forcing the applicant to re-zone land which would also allow many other permitted uses under the new district if the proposed use is not actually developed. (Ord 449)

B. Definitions.

1. "Conditional use" means a use allowed under a conditional use permit, special exception, or other special zoning permission issued by a city, but does not include a variance.

2. "Substantial evidence" means facts and information, other than merely personal preferences or speculation, directly pertaining to the requirements and conditions an applicant must meet to obtain a conditional use permit and that reasonable persons would accept in support of a conclusion.

C. Procedure. Only those uses listed as Conditional Uses in the individual districts of Section 17.08 of this ordinance can be considered for being permitted in such district.

1. Application; Conditional Use Fee. Application for a conditional use must be made to the Building Inspector. The necessary information as determined by the Building Inspector shall be furnished by the applicant. The applicant shall pay a fee of \$75.00 at the time the application is submitted to the Building Inspector. (Ord. 525, 2003)

2. Publication and Notice. Notice of the time and date when the Plan Commission and City Council shall consider the application shall be given by publication as a Class II Notice, and by mailing same notice to the owners of property within 100 feet of the parcel for which conditional use is requested. (Ord. 525, 2003)

3. Plan Commission Review. The conditional use application shall be considered by the City Plan Commission, which may make a recommendation to the City Council on same. Conditions can be attached to the recommended approval of a conditional use consistent with the intent of this section. (Ord. 525, 2003)

4. Hearing and Final Determination. The City Council shall make the final determination of a conditional use. The City Council may attach conditions to the issuance of a permit. All conditional use permits shall be valid only for the use specified on said permit and the permit shall expire at the time that any such conditional use shall terminate. Conditional use permits shall not be transferable to other uses on the same site nor shall the permit be transferred to a different location from that described on the permit. (Ord. 525, 2003)

D. Standards. In reviewing the application for conditional use, the following standards shall be considered:

1. That the establishment, maintenance, or operation of the use will not be detrimental to, or endanger the public health, safety, morals, comfort or general welfare;

2. That the use will not be injurious to the use and enjoyment of other property in the immediate vicinity for the purpose already permitted, nor substantially diminish and impair property values within the neighborhood;

3. That the establishment of the use will not impede the normal and orderly development and improvement of the surrounding property for uses permitted in the district;

4. That the exterior architectural appeal and functional plan of any proposed structure will not be so at variance with either the exterior architectural appeal and functional plan of the structures already constructed or in the course of construction in the immediate neighborhood or in the character of the applicable district, as to cause a substantial depreciation in the property values within the neighborhood;

5. That adequate utilities, access roads, drainage and/or necessary facilities have been or are being provided;

6. That adequate measures have been or will be taken to provide ingress and egress so designed as to minimize traffic congestion in the public streets;

7. That the proposed use is not contrary to the objectives of any duly adopted land-use plan for the City of Viroqua, any of its components, and/or environs;

8. That the use shall, in all other respects, conform to the applicable regulations of the district in which it is located, except as such regulations may, in each instance, be modified pursuant to the recommendations of the Plan Commission.

E. Review and Approval.

1. If an applicant for a conditional use permit meets or agrees to meet all of the requirements and conditions specified in the city ordinance or those imposed by the Plan Commission and/or City Council, the city shall grant the conditional use permit. Any condition imposed must be related to the purpose of the ordinance and be based on substantial evidence.

2. The requirements and conditions described under Subsection 1 must be reasonable and, to the extent practicable, measurable and may include conditions such as the permit's duration, transfer, or renewal. The applicant must demonstrate that the application and all requirements and conditions established by the city relating to the conditional use are or shall be satisfied, both of which must be supported by substantial evidence. The city's decision to approve or deny the permit must be supported by substantial evidence.

3. Changes in use subsequent to the initial issuance of a conditional use permit shall result in a need to change the initial conditions and shall require an amendment to the conditional use permit. If any holder of a conditional use permit wishes to extend or alter the terms of such permit, the permit holder must apply for an amendment to the conditional use permit through the procedure of application for conditional use permits detailed herein. The process for amending a permit shall generally follow the procedures for granting a permit as set forth in this Chapter and shall require the filing of an application and a hearing as provided above.

F. Termination of Conditional Use Permit. Conditional use status will terminate when the City Council determines any of the following:

1. The permit holder has failed to comply with the conditions of the permit or the conditional use has otherwise not continued in conformity with the conditions of the permit.

2. A change in the character of the surrounding area or in the conditional use itself causes such use to be no longer compatible with the surrounding uses.

3. The use or the characteristics of the use have changed without amending the permit and obtaining approval of the City Council as provided in Section 17.04.090 D (3).

4. The conditional use has been discontinued for a period of 12 consecutive or 18 cumulative months in a three year period. A business of a seasonal nature shall not be deemed discontinued during periods in which it is normally inactive (i.e., summer camps, snowmobile courses, ski areas, quarries, etc.). Upon such determination, the owner of the premises shall be required to bring all such lands and buildings into conformity with the district regulations of the district in which such former conditional use is located, and all other provisions of this chapter within 90 days from such determination.

5. Prior to terminating a conditional use permit, the City Council shall hold a public hearing, giving public notice as specified in Section 17.04.090 C (2) of this ordinance. The termination of the conditional use shall not result in any nonconforming rights and the entire use shall be ceased. The property formerly the subject of the conditional use shall thereafter be used only in conformity with the current zoning and other village ordinances and regulations.

6. A Conditional Use Permit may be terminated on request when the applicant or holder of the Conditional Use and the property owner make a request in writing to the Plan Commission that the Conditional Use be terminated and the Plan Commission agrees to terminate said Conditional Use Permit.

G. In the event any use is listed as a conditional use and a permitted use in the same district, the use shall be permitted.

17.04.100 Nonconforming Premises and Uses. The lawful use of a building or premises existing at the time of the adoption or amendment of this ordinance may be continued although such use does not conform with the provisions of the ordinance. Such nonconforming use may not be extended. The total structural repairs or alterations in such a nonconforming building shall not during its life exceed 50 per cent of the assessed value of the building unless permanently changed to a conforming use. If such nonconforming use is discontinued for a period of 12 months, any figure use of the building and premises shall conform to the ordinance.

17.04.110 Temporary Building Permit Moratorium.

A. Preliminary Determination. Whenever the Building Inspector finds that any of the following exist, no building permit may be issued for six months except upon conditions imposed by the City Council after advice from the Plan Commission.

1. The premises abuts a public street that is not opened; or open but not surfaced; or open and surfaced but which is scheduled for repairs or excavation for public utilities;
2. Municipal water is not available to the premises;
3. The premises is serviced by public sewer that is scheduled for replacement or repair.
4. An application to change the zoning of the premises, or adjacent premises, is pending;
5. A nonconforming use exists upon the premises and the permit, if granted, would either extend the nonconforming use or involve structural repairs or alterations exceeding 50% of the assessed value of a nonconforming structure.
6. ON adjacent property, the required yard size does not comply with this ordinance (either because of lawful nonconforming use or variances) and the proposed use of the premises would present obstacles to adequate fire or police protection;
7. Curb, gutter, or sidewalk improvements abutting the premises are scheduled.

B. Final Determination. If the City Council upholds the Building Inspector's preliminary determination on the denial of a Building Permit the City Council can extend the Permit moratorium for a period not to exceed six months from the date of permit application, during which time the City and the applicant shall make arrangements to deal with the problems that would be induced by the proposed use.

17.04.120 Fences. (a) Fences Defined. For the purpose of this Section, a "fence" is herein defined as an enclosed barrier consisting of wood, stone or metal intended to prevent ingress or egress. No fence shall be constructed of unsightly or dangerous materials which would constitute a nuisance.

(b) Fences Categorized. Fences shall be categorized into five classifications:

(1) Boundary Fence. A fence placed on or within three feet of the property lines of adjacent properties.

(2) Protective Fence. A fence constructed to enclose a hazard to the public health, safety and welfare.

(3) Architectural or Aesthetic Fence. A fence constructed to enhance the appearance of the structure or landscape.

(4) Picket Fence. A fence having a pointed post, stake, pale or peg laced vertically with the point or sharp part pointing upward to form a part of the fence.

(c) Height of Fences Regulated. (1) Residential fences six feet or less in height are permitted on rear and side lot lines. Residential fences less than or equal to four feet in height are permitted in the street yard setback area but shall not be closer than two feet to any public right-of-way and shall be subject to the requirements of Section 17.04.080 F 3. All fences must be constructed and maintained in a good state of repair and appearance.

(2) No fence shall be erected, placed, maintained or grown along a lot line on any non-residentially zoned property, adjacent to a residentially zoned property, to a height exceeding eight feet.

(d) Fences Placement. Fences in or adjacent to a residential property shall have a minimum three feet side and rear yard setback, except as the adjoining property owners may otherwise agree in writing as a part of the application for a permit. Fences shall be constructed alongside lot lines but must be so placed to allow the fence owner to maintain both sides of the fence, on their property. The fence owner shall properly trim weeds and grasses around the fence.

(e) Security Fences. Security fences shall not exceed eight feet in height and shall be of an open type similar to woven wire or wrought iron fencing.

(f) Prohibited Fences. No fence shall be constructed which is in a dangerous condition, or which conducts electricity or is designed to electrically shock or which uses barbed wire, provided, however that barbed wire may be used in industrially zoned areas if the devices securing the barbed wire to the fence are eight feet above the ground or height and project toward the fenced property and away from any public area.

(g) Fences to be Repaired. All fences shall be maintained and kept safe and in a state of good repair, and the finished side or decorative side of a fence shall face adjoining property.

(h) **Temporary Fences.** Fences erected for the protection of planting or to warn of construction hazard, or for similar purposes, shall be clearly visible or marked with colored streamers or other such warning devices at four foot intervals. Such fences shall comply with the setback requirements set forth in this Section. The issuance of a permit shall not be necessary for temporary fences as described herein, but said fences shall not be erected for more than forty-five days.

(i) **Nonconforming fences.** Any fence existing on the effective date of this Code of Ordinances and not in conformance with this Section may be maintained, but no alteration, modification or improvement of said fence shall comply with this Section.

(j) **Fence Permit.** No person shall erect a fence in the City unless a permit is first obtained by the owner or his agent from the Building Inspector. The applicant shall submit design specifications for approval and pay required permit fees at the time of making application.

(k) **Property Boundary Determinations.** Fences shall be erected on the owner's property and responsibility for establishing the property line shall rest with the property owner erecting the fence. The dress side of the fence shall be on the outside. All parts of the fence shall be erected on the owner's property.

(l) **Snow Fences.** Utility snow fences may be used only during the winter months and shall be removed at the end of each winter season.

17.04.130 Swimming Pools. (a) **Definition.** A "swimming pool" is a body of water or an outdoor structure containing a body of water in a receptacle or other container having a depth for water at any point greater than one and one-half feet located above or below the surface of ground elevation, installed in such a manner that the pool will remain in place as a fixture throughout the full year and will be considered as a permanent or semi-permanent structure on the land. The term includes all structural facilities, appliances and appurtenances, equipment and other items used and intended to be used for the operation and maintenance of a private or residential swimming pool. Excluded from the definition "swimming pool" is a so-called hot tub or spa which has a cover that prevents unauthorized access.

(b) **Exempt Pool.** A body of water that would otherwise be a "swimming pool" but is intended and used as a decorative pond is exempt from the provisions of this Section. Storable children's swimming or wading pools, with a maximum dimension of fifteen feet and a maximum wall height of fifteen inches and which are so constructed that they may be readily disassembled for storage and reassembled to original integrity are exempt from the provisions of this Section

(c) **Permit Required.** Before work is commenced on the construction or erection of private or residential swimming pools or on any alterations, additions, remodeling or other improvements, an application for a swimming pool building permit to construct, erect, alter,

remodel or add must be submitted in writing to the Building Inspector. Plans and specifications and pertinent explanatory data should be submitted to the Building Inspector at the time of application. No work or any part of the work shall be commenced until a written permit for such work is obtained by the applicant. The required building permit fee pursuant to the City Building Code shall accompany such application.

(d) Construction Requirements. In addition to such other requirements as may be reasonably imposed by the Building Inspector, the Building Inspector shall not issue a permit for construction as provided for in Subsection (b), unless the following construction requirements are observed:

(1) Approved Materials. All materials and methods of construction in the construction, alteration, addition, remodeling or other improvements and pool installation shall be in accord with all state regulations and code and with any and all ordinances of the City now in effect or hereafter enacted.

(2) Plumbing. All plumbing work shall be in accordance with all applicable ordinances of the City and all state codes. Every private or residential swimming pool shall be provided with a suitable draining method and, in no case, shall waters from any pool be drained into the sanitary sewer system, onto lands of other property owners adjacent to that on which the pool is located on in the general vicinity.

(3) Electrical Installations. All electrical installations, including lighting and heating but not limited thereto, which are provided for, installed and used in conjunction with a private swimming pool shall be in conformance with the state laws and City ordinances regulating electrical installations.

(e) Setbacks and Other Requirements. (1) Private swimming pools shall be erected or constructed on rear or side lots only and only on a lot occupied by a principal building. No swimming pool shall be erected or constructed on an otherwise vacant lot. A lot shall not be considered vacant if the owner owns the contiguous lot and said lot is occupied by a principal building.

(2) All swimming pools shall be at least ten feet from any lot line or building unless designed and approved as an addition to a building.

(f) Enclosure. (1) Fence: In-ground Pools. All outdoor, below grade swimming pools shall have a fence or other solid structure not less than four feet in height completely enclosing the pool with no opening therein (other than doors or gates) larger than three inches square. All gates or doors opening through the enclosure shall be kept securely closed and locked at all times when not in actual use and shall be equipped with a self enclosing and self-latching device designed to keep and be capable of keeping such door or gate securely locked at all times when not in actual use.

(2) Above-ground Pools; Pool Wall Barrier. a. An approved barrier shall consist of a solid wall of durable material of which the pool itself is constructed and shall extend directly above the vertical water enclosing wall of the pool. Such walls shall extend more

than three feet above the level of the ground immediately adjacent to the pool. Such a solid pool wall barrier shall not be located within six feet of any other wall or fence or other structure which can be readily climbed by children. Every entrance to a pool, such as a ladder, must be secured or adequately safeguarded to prevent unauthorized entry into the pool.

b. The pool enclosure may be omitted where portable pools are installed above ground and have a raised deck around the entire pool perimeter with an attached enclosed railing a minimum of thirty-six inches high on the top.

(g) Compliance. All swimming pools existing at the time of passage of this Code of Ordinances not satisfactorily fenced shall comply with the fencing requirements of this Section or when water is placed in the pool. Enclosures on existing pools shall be inspected by the Building Inspector for compliance. Variations in enclosure requirements that do not adversely affect the safety of the public may be approved.

(h) Draining and Approval Thereof. No private swimming pool shall be constructed so as to allow water therefrom to drain into any sanitary sewer nor to overflow upon or cause damage to any adjoining property. Provisions may be made for draining the contents of any swimming pool into a storm sewer, but such installation shall be subject to prior approval by the Plumbing Inspector.

(i) Filter Systems Required. All private swimming pools within the meaning of this Chapter must have, in connection therewith, some filtration system to assure proper circulation of the water therein and maintenance of the proper bacterial quality thereof.

(j) Dirt Bottoms Prohibited. All swimming pools of a permanent nature shall have the sides and bottom of a smooth finish, and no sand or dirt bottom shall be permitted.

(k) Maintenance. All private pools shall be maintained in accordance with manufacturer instructions. All pools shall meet water quality standards as may be established for pools by the Wisconsin Department of Health and Social Services and the City Board of Health.

Chapter 17.08

ZONING DISTRICTSSections:

- 17.08.010 A-1 Agricultural Transition District
- 17.08.010 C-1 Conservancy District
- 17.08.010 R-1 Single and Two-Family Residence District
- 17.08.010 R-2 Multiple Family Residence District
- 17.08.010 R-3 Mobile Home Park District
- 17.08.020 B-1 Central Business District
- 17.08.020 B-2 Commercial District
- 17.08.020 B-3 Industrial District
- 17.08.020 B-4 Industrial Park District
- 17.08.020 B-5 Gateway Business Park

17.08.010 A-1 Agricultural Transition District

1. Intent: This District is intended to provide for open space particularly in those areas of the City to reduce the need for and cost of public services, or to be applied in those areas of the City where natural environmental conditions present physical development problems. A further purpose is to help preserve the open space and natural scenic and ecological qualities in special areas.

2. Permitted uses:

- a. Any existing agricultural use (including the residence of persons operating the farm on which the residence is located), except swine and fowl farming. (Ord 05OR005)
- b. Public roads and streets.

3. Conditional uses:

- a. Any utility structure substation, transmission line or pipe line.
- b. Private roads and streets.
- c. Any other agricultural uses (except swine and fowl may not be allowed as conditional uses). (Ord 05OR005)
- d. Parks, county fair, playground and athletic fields, open space leisure and recreational activities which do not disrupt natural conditions. (Ord 05OR005)

4. Minimum Standard for Agricultural Transition District.

Use	Dwellings	All other Permitted Uses	Conditional Uses
Lot area and Density		5 acres	As set by the Plan Commission and City Council
Lot Width		200 feet	
Height of Structure		50 feet	
Side Yard		10 feet	
Street Setback		25 feet	
Rear Yard		25 feet	
Parking		Per 17.04.080 H	
Area of Structure		0	

17.08.010 C-1 Conservancy District.

1. Intent. This district is intended to include areas for which the use is outdoor recreation or other public uses; to include lands which are limited for development because of soil, slope, water table or other condition; and for the preservation of scenic, historic or scientific areas.

2. Permitted Uses.
 - a. Outdoor play fields and playgrounds.
 - b. Swimming Pools.
 - c. Hiking Trails.
 - d. Picnic areas.
 - e. Open areas.
 - f. Public toilets.
 - g. Tree plantations.
 - h. Public exposition and recreation buildings.
 - i. Parks.
 - j. Fair grounds.
 - k. School grounds and accessory uses.
3. Conditional uses.
 - a. Cemeteries.
 - b. Armories.

17.08.010 R-1 Single and Two-Family Residence District

1. Intent: This district is intended to maintain areas characterized by single and two-family residences.

2. Permitted uses.

- a. Single and two-family residences.
- b. Flower and vegetable gardens not for commercial use.
- c. Churches, convents, chapels, temples, synagogues, parish or rectory houses.
- d. Fire and police stations, libraries, government administration facilities.
- e. Home occupation / professional home office.

f. A building on the lot line when constructed with a wall in common with a building upon the adjacent lot, on condition that all other requirements of the zoning code and the Viroqua Municipal Code shall be adhered to. (Ord. 409, 1989)

3. Conditional uses.

a. Conditional uses in the A-1 District: (1) any utility structure substation, transmission line or pipe line; (2) Private roads and streets; (3) agricultural uses not otherwise permitted (except swine and fowl may not be allowed as conditional uses) (Ord 05OR005); and (4) Parks, county fair, playground and athletic fields, open space leisure and recreational activities which do not disrupt natural conditions. (Ord 05OR005)

- b. Multiple family residence not exceeding 4 units per dwelling.
- c. Center, museum, and clubs or associations not open to the public.
- d. Junior and Senior High Schools.
- e. Public and parochial elementary schools and day care and nursery schools;

f. Golf courses and the following accessory uses: clubhouses, pro shop, restaurant and bar, swimming pool and tennis courts.

- g. Boarding houses and lodging houses.
- h. Parking lots for motor vehicles. (Ord 477, 1997)
- i. Parks, county fair, playground and athletic fields, open space leisure and recreational activities which do not disrupt natural conditions. (Ord 05OR005)
- j. Private non-commercial recreational areas and facilities. (Ord 05OR005)

4. Minimum Standards for Single and Two Family District.

In determining the set back requirements, measurement shall be made from the point on the structure closest to the lot line, provided, that for any structure with a roof having not more than a 2 foot overhang, measurement shall be made from the structure's wall nearest the lot line.

Use	Dwellings	All other Permitted Uses	Conditional Uses
Lot Area	One family per unit. One unit or or two attached units per lot, provided lot is 6,000 square ft.	6000 square feet lot area	As set by the Plan Commission and City Council.
Lot Width	50 feet	60 feet for corner lots	
Height of Structure	35 feet		
Side Yard	10 feet		
Street Setback	25 feet		
Rear Yard	Not less than 15 feet		
Parking	Per 17.04.080 H		
Area of Structure	600 square feet per dwelling unit.		

17.08.010 R-2 Multiple Family Residence District

1. Intent: This district is intended to provide a medium density, mixed residential district intended to provide a transition between detached housing and more intense non-residential areas.

2. Permitted uses.

a. Permitted uses in the R-1 district: (1) Single and two-family residences; (2) Flower and vegetable gardens not for commercial use; (3) Churches, convents, chapels, temples, synagogues, parish or rectory houses; (4) Fire and police stations, libraries, government administration facilities; (5) Home occupation / professional home office; (6) A building on the lot line when constructed with a wall in common with a building upon the adjacent lot, on condition that all other requirements of the zoning code and the Viroqua Municipal Code shall be adhered to. (Ord. 409, 1989).

b. Multiple family dwellings not exceeding 4 units. (Ord 05OR005)

c. Private clubs, lodges, fraternities, sororities, except those the principal use of which is a service customarily carried on as a business.

d. Funeral Homes.

3. Conditional uses.

a. Conditional uses in the R-1 district: (1) Multiple family residence not exceeding 4 units per dwelling; (2) Center, museum, and clubs or associations not open to the public; (3) Junior and Senior High Schools; (4) Public and parochial elementary schools and day care and nursery schools; (5) Golf courses and the following accessory uses: clubhouses, pro shop, restaurant and bar, swimming pool and tennis courts; (6) Boarding houses and lodging houses; (7) Parking lots for motor vehicles. (Ord 477, 1997); (8) Parks, county fair, playground and athletic fields, open space leisure and recreational activities which do not disrupt natural conditions. (Ord 05OR005); (9) Private non-commercial recreational areas and facilities. (Ord 05OR005).

b. Hospitals.

c. Rest homes, nursing homes and homes for the aged.

d. Greenhouses.

e. Professional offices that do not conduct any retail or wholesale operations from the premises except for any incidental sales not significant in the operation of the business, such as: accountants, architects and engineers, art and music and dance studios and shops, artist and photographers studios, barber and beauty shops, medical and dental offices, insurance offices, business and tax consultants, sales person's office, law office, real estate office, union office.

f. Parking lots serving any commercial use and not exceeding 20 spaces.

g. The following uses, separately or together, when they constitute part of a common purpose of assisting individuals in becoming self-sufficient: clinic, health spa, restaurant, retail store, production center, mail order catalog shipping, day care center, seminar and fundraising centers. (Ord. 456, 1995)

h. Multiple family dwellings exceeding 4 units. (Ord 05OR005)

i. Pet grooming. (Ord 05OR008)

j. Restaurant or café on non-residential property run by a 501(c)(3) charitable organization in support of its charitable purpose. Operation of restaurant or café under this section is limited to Monday through Friday between the hours of 11:00 a.m. and 2:00 p.m. (Ord 17OR003)

4. Minimum Standard for Multiple Family District

Use	Dwellings	All other Permitted Uses	Conditional Uses
Lot Area and Density	2000 square feet of lot area per unit. In no case shall a dwelling with one or two units have less lot area than 6,000 square feet.	6000 square feet lot area.	As set by the Plan Commission and City Council.
Lot Width	50 feet – 60 feet for corner lots.		
Height of Structure	45 feet		
Side yard	10 feet		
Street setback	25 feet		
Rear Yard	Not less than 15 feet		
Parking	Per 17.04.080 H		
Area of Structure	600 square feet per unit		

17.08.010 R-3 Mobile Home Park District.

- 1. Intent. This district is intended to provide for mobile home parks.
- 2. Permitted uses.
 - a. New Mobile Home Parks.
 - b. Existing Mobile Home Parks.
- 3. Minimum Standard for Mobile Home Park District.

USE	ALL USES
Site Area and Density	3000 square feet for each mobile home space.
Lot Width	40 feet width for each mobile home space. Side yard for basic unit shall be no closer than 10 feet to side site line.
Height of Structure.	35 feet
Yards	No mobile home shall be closer than 25 feet from any property line bordering the park.
Street setback	All mobile home spaces shall abut upon a public street. Mobile homes shall be setback 15 feet from street.
Rear Yard	15 feet from rear site line.
Parking	Per 17.04.080 H
Area of Structure	600 square feet per unit.

17.08.020 B-1 Central Business District.

1. Intent. This district is intended to maintain areas characterized by business uses in the center of the City, with heavy pedestrian traffic.

2. Permitted Uses. The retail sale or service of any of the following businesses:

- a. Plumbing, heating, electrical, lighting, and paint sales and service.
- b. Household equipment sales and service, hardware, lawn and garden supplies, building supplies, except lumberyards.
- c. Post Office.
- d. Department stores and discount variety stores and retail stores.
- e. Travel bureaus.
- f. Cleaning and pressing establishments making exclusive use of a dry-cleaning process recognized by the State as not emitting offensive odors and having a flash point sufficiently high that no undue hazard is created by its use on the premises.
- g. Dress shop, clothing store, notion shop, dry goods store, tailor shop.
- h. Drug store, pharmacy.
- i. Florist shop.
- j. Food products (retail, restaurants).
- k. Gift shop, coin shop, book store, arts and crafts.
- l. Financial, business, professional and medical institutions.
- m. Jewelry store.
- n. Music, TV and radio store.
- o. Commercial and public parking lots and ramps.
- p. Photographer and photographer's supplies.
- q. Printing and publishing.
- r. Farmer's market, bazaars, open spaces markets in areas designated.
- s. Theaters, except drive-in theaters. (Ord 05OR005)
- t. Any other uses similar in character and the manufacture or treatment of products clearly incidental to the conduct of a retail business on the premises.
- u. Hotels and motels.
- v. Veterans Memorials. (Ord. 542, 2003)
- w. Library (Ord. 550, 2003)

3. Conditional uses.

a. Permitted uses in Multiple Family district except single family dwelling: (1) two-family residences; (2) Flower and vegetable gardens not for commercial use; (3) Churches, convents, chapels, temples, synagogues, parish or rectory houses; (4) Fire and police stations, libraries, government administration facilities; (5) Home occupation / professional home office; (6) A building on the lot line when constructed with a wall in common with a building upon the adjacent lot, on condition that all other requirements of the zoning code and the Viroqua Municipal Code shall be adhered to. (Ord. 409, 1989)

b. The “wholesale” aspect of any of the foregoing businesses.

c. Gas and service stations and repair shops.

d. Taverns, night clubs, beer and liquor stores.

e. Bowling alleys, roller skating rink.

f. Farm implement and trailer sales and repair.

g. Microwave relay towers.

h. Lumber yards.

i. Animal hospitals and veterinary clinics.

j. Automobile sales establishments, garages and parking lots, but not salvage, wrecking, rebuilding, storage or parking operations. (Ord 05OR005)

4. Minimum Standard for Central Business District.

Use	Dwellings	All other Permitted Uses	Conditional Uses
Lot Area and Density		0	
Lot Width		20 feet	
Height of Structure		35 feet – 85 feet if fire prevention system approved by Fire Department	
Side Yard		0 – 5 feet if any side yard is provided and 5 feet if it abuts residence district	
Street Setback		0	

November 2011 revision

17.08.020
B-1 Central Business District

Rear Yard	5 feet
Parking	Per 17.04.080 H
Area of Structure	0

17.08.020 B-2 Commercial District

1. Intent. This district is intended to maintain areas characterized by a mixture of residential and commercial uses, with light pedestrian traffic and heavy automotive traffic requirements and parking requirements.

2. Permitted Uses.

- a. Permitted uses in B-1 District:
- Plumbing, heating, electrical, lighting, and paint sales and service.
 - Household equipment sales and service, hardware, lawn and garden supplies, building supplies, except lumberyards.
 - Post Office.
 - Department stores and discount variety stores and retail stores.
 - Travel bureaus.
 - Cleaning and pressing establishments making exclusive use of a dry-cleaning process recognized by the State as not emitting offensive odors and having a flash point sufficiently high that no undue hazard is created by its use on the premises.
 - Dress shop, clothing store, notion shop, dry goods store, tailor shop.
 - Drug store, pharmacy.
 - Florist shop.
 - Food products (retail, restaurants).
 - Gift shop, coin shop, book store, arts and crafts.
 - Financial, business, professional and medical institutions.
 - Jewelry store.
 - Music, TV and radio store.
 - Commercial and public parking lots and ramps.
 - Photographer and photographer's supplies.
 - Printing and publishing.
 - Farmer's market, bazaars, open spaces markets in areas designated.
 - Theaters, except drive-in theaters. (Ord 05OR005)
 - Any other uses similar in character and the manufacture or treatment of products clearly incidental to the conduct of a retail business on the premises.
 - Hotels and motels.
 - Veterans Memorials. (Ord. 542, 2003)
 - Library (Ord. 550, 2003)

- b. Bowling alley, roller skating rink.
- c. Mobile Home Sales.
- d. Farm implement and trailer sales and repair.
- e. Wholesale and distributing establishments.
- f. Commercial or institutional recreational game fields, swimming pools, skating, golf, driving ranges, miniature golf, or similar open air recreational uses and facilities. (Ord 05OR005)
- g. Bottling and distributing plants.
- h. Gasoline service stations.
- i. Lumber yards.
- j. Dry cleaning, and laundry cleaning establishments.
- k. Self-service storage.
- l. Library (Ord. 550, 2003)
- m. Automobile sales establishments, garages and parking lots (Ord 05OR005)

3. Conditional Uses.

- a. Conditional Uses in B-1 District:
 - Gas and service stations and repair shops;
 - Taverns, night clubs, beer and liquor stores.
 - Bowling alleys, roller skating rink.
 - Farm implement and trailer sales and repair.
 - Microwave relay towers.
 - Lumber yards.
 - Animal hospitals and veterinary clinics.
 - Automobile sales establishments, garages and parking lots, but not salvage, wrecking, rebuilding, storage or parking operations. (Ord 05OR005)
- b. Taverns, night clubs, beer and liquor stores.
- c. Transfer, storage, moving, freight and parcel delivery operations.
- d. Wholesale trade not involving air, water or soil pollution or noise, residential uses.
- e. Dwellings.
- f. Animal hospital and veterinary clinics.
- g. Manufacturing or assembling operations, which do not involve excessive noise, and which do not result in any air or water pollution, when the manufactured or assembled products are offered for sale at retail on the site. (Ord. 532, 2003)
- h. Go-cart tracks (Ord 05OR005)
- i. Day care and nursery school (Ord 12OR003)

4. Minimum Standard for Commercial District

Use	All other Permitted Uses	Conditional Uses
Lot Area and Density	6000 square feet lot area	As set by the Plan Commission and City Council
Lot Width	50 feet	
Height of Structure	35 feet – 85 feet if fire prevention system approved by Fire Department	
Side Yard	0 5 feet if any side yard is provided and 5 feet if abuts residence district	
Street Setback	25 feet	
Rear Yard	Not less than 15 feet	
Parking	Per 17.04.080 H	
Area of Structure	0	

17.08.020 B-3 Industrial District

1. Intent. This district is intended to provide for areas having moderate to intense processing, employment, traffic and other related activities. It is intended that this district generally be located distant from residential uses and that it be buffered by commercial districts, major roads, or open space.

2. Permitted uses.

Industrial and commercial businesses except: animal rendering and businesses involving air, water, or soil pollution or disturbance.

3. Conditional uses.

a. Residential, when incidental to a permitted business requiring the presence of a caretaker.

b. Slaughter house, stock yards or meat packing or processing plants.

c. Race tracks for stock cars, snowmobiles, mini bikes, and other motorized vehicles for demonstration and exhibitions.

d. Boarding kennels.

e. Petroleum products manufacturing, refining and storage.

f. Chemical manufacturing.

g. Wholesale gasoline, sales or storage.

h. Landfills.

i. General Aviation Airports (Ord 05OR005)

17.08.020 . B-4 Industrial Park District

1. General Purposes. Property in the Viroqua Industrial Park is subject to the conditions, restrictions, and protections hereby declared to insure proper use and appropriate development and improvement of each building site therein, to protect the environment in the industrial park; to guard against the erection thereon of structures of unsuitable materials; to require conformance to applicable ordinances and building code; to insure reasonable development of said property and locations thereon of buildings; to control the development of said property as an industrial park including, but not limited to, proper setbacks from the street, adequate free space between structures, adequate parking, and in general to provide for a high quality of improvement of said property; to insure that each building site shall not adversely affect the general plan of physical development of the industrial park nor adversely affect the health or safety of residents or workers in the area nor be detrimental to the use or development of other properties in the Viroqua Industrial Park.

2. Permitted Uses. In the Industrial Park District, unless otherwise provided in this Title, land or buildings may be used for any purpose except the following uses (Ord 10OR003):

- a. Residential
- b. Commercial
- c. Abattoirs (slaughter house)
- d. Acid manufacture
- e. Asphalt manufacture
- f. Cement, lime, gypsum or plaster of paris manufacture
- g. Explosive manufacture or storage
- h. Fertilizer manufacture
- i. Garbage, rubbish, offal or dead animal reduction
- j. Glue manufacture
- k. Junk yards
- l. Petroleum refining
- m. Smelting of ferrous and non-ferrous metals
- n. Stockyards
- o. Tannery

3. Conditional Uses:

a. Commercial, defined as buying, selling, or transporting of commodities. (Ord 10OR003).

b. Fitness and wellness centers. (Ord. 17OR006).

c. Solid waste transfer stations. (Ord. 17OR009).

4. Conformance to Codes: Permitted and Conditional uses shall be conducted within acceptable standards in local, state and national codes pertaining to noise, vibrations, smoke, toxic or noxious matter, odorous matter, fire and explosive hazards, glare or heat, air pollution, water pollution and maintenance of property. (Ord 10OR003).

5. Minimum Lot Sizes. Lots may be of any size.

6. Setbacks. No building shall be constructed on the site nearer than 25 feet of the right-of-way of any county, state or federal highway.

7. Side Yard. Minimum side yards shall be 15 feet. In the event that two adjoining sites shall be owned by the Grantee and in the improvement of such sites a building shall be erected on these combined sites, then the side yard requirements on the interior lines are waived.

8. Rear yard. Rear yards shall be a minimum of 15 feet. In the event that two adjoining sites shall be owned by the Grantee and in the improvement of such sites, a building shall be erected on these combined sites, then the rear yard requirements are waived.

9. Vehicle parking and loading docks. Sufficient off-street parking shall be provided for employees, customers, and visitors as follows:

- a. Parking is prohibited within 25 feet of any county, state or federal highway;
- b. Employee, customer or visitor parking will not be permitted on public streets in the Viroqua Industrial Park;
- c. Total parking space shall be a minimum of 180 square feet per parking stall, excluding drives and approaches;
- d. A minimum parking ratio of one space for each two employees shall be provided;
- e. No loading or unloading shall be permitted on, or which results in obstruction of public streets; loading docks shall not be located on the sides of any building facing any county, state or federal highway.

10. Landscaping and Maintenance. The entire setback area shall be graded and sodded or seeded between the lot lines and from the street shoulder to the building face. All landscaping, planting, etc. shall be done in suitable manner so that it will produce an acceptable appearance, excepting only those areas as may be required for driveways, visitor parking or walks. All driveways, walks and permanent parking areas shall be surfaced with hot-mix asphalt concrete, or cement concrete. Paved areas and landscaping shall be completed within one year after occupancy of building. The owner of any tract in this Park must at all times keep the premises, buildings, improvements and appearance in a safe, neat and clean condition and comply in all respects with all government, health and local policy requirements. The owner will remove at his or her own expense any rubbish of any character whatsoever which may accumulate on said property with the exception of ordinary city garbage collection.

11. Outdoor Storage. No outside storage of any kind shall be permitted unless such stored material is visually screened from all streets with a suitable fence at least six feet in height. Screening shall be attractive in appearance and in keeping with the architectural quality of the main structure. Said storage shall be limited to the rear two-thirds of the property, and within building setback lines. No waste material or refuse may be dumped or permitted to remain on any part of the property outside of the buildings. Storage of fuel oil or other bulk fluids must be underground. Fences, walls or hedges may not extend forward of building setback lines.

17.08.020 B-5 Gateway Business Park

1. **Intent.** Property in the “Gateway Business Park” is subject to the conditions, restrictions, and protections hereby declared to insure proper use and appropriate development and improvement of each building site therein. The City of Viroqua recognizes the importance of quality design in preserving the community’s distinctive natural setting and high quality of life; in promoting sustainable design practices; and in maintaining competitiveness within area real estate markets. The purpose of the following zone standards is to ensure quality site planning and building design that:

- a. create high quality site improvements that meet applicable ordinances and building code;
- b. create reasonable development of property and locations thereon of buildings and parking lots;
- c. unify the natural and built features of the community specifically with regard to natural features;
- d. minimize environmental impacts including stormwater runoff, light spill, and air/waste discharge;
- e. prevent development that would adversely affect residents, workers and or the development of other properties in the Gateway Business Park;
- f. are compatible with and promote agribusiness and tourism as key industries within Vernon County;
- g. are compatible with and promote downtown Main Street as an essential component of a vibrant and robust community;
- h. establish benchmarks for future design; and
- i. encourage sustainability, conservation and energy efficiency.

2. **Permitted Uses.** In the Gateway Business Park District land or buildings may be used for the following purposes:

a. Commercial Retail. The following uses are only allowed within .25 miles of State Highway 14/61:

- (i). Auto dealerships, service and repair.
- (ii). Clothing stores.
- (iii). Convenience shopping.
- (iv). Department stores or shopping centers.
- (v). Discount retail stores.
- (vi). Drug stores and print shops.
- (vii). Event spaces.
- (viii). Food stores.
- (ix). Furnitures stores.
- (x). Gym, fitness or sports centers.
- (xi). Lodging facilities and tourist accommodations.
- (xii). Bars and restaurants.
- (xiii). Salons and spas.
- (xiv). Specialty retail stores and gift shops.
- (xv). Sporting goods stores.
- (xvi). Theaters.

b. Light Industrial. Retail uses are not permitted except as supporting principal use - limited to fifteen percent (15%) of the square footage of the development. Storage and wholesale to retailers from the premises of finished goods and food products is also allowed. The following uses are permitted but are not allowed directly adjacent to State Highway 14/61:

- (i). Breweries.
- (ii). Commercial screen printing (not including print shops).
- (iii). Custom-made product manufacturing, processing, assembling, packaging and fabrication of goods.
- (iv). Food production.
- (v). Freight handling and shipping.
- (vi). Labor intensive manufacturing, assembly and repair processes.
- (vii). Manufacturing, compounding of materials, processing, assembling, packaging, treatment or fabrication of materials.
- (viii). Storage and wholesaling of unrefined raw or semi-refined products requiring further processing or manufacturing.
- (ix). Truck services and terminals.

- (x). Warehousing within enclosed building.
- (xi). Wine and liquor wholesalers.

c. Commercial Non-Retail. The following uses are permitted throughout the B-5 Gateway Business Park.

- (i). Agricultural innovation and educational centers.
- (ii). Biotechnology, software, hardware development and electronics.
- (iii). Brewpubs and distilleries.
- (iv). Business support services.
- (v). Childcare facilities.
- (vi). Corporate/administrative offices.
- (vii). Governmental offices and community facilities.
- (viii). Greenhouses.
- (ix.) Single tenant or multi-tenant professional offices that do not conduct any retail or wholesale operations from the premises except for any incidental sales not significant in the operation of the business, such as: accountants, architects and engineers, art and music and dance studios, photography studios, medical and dental offices, insurance offices, business and tax consultants, law offices and real estate offices.
- (x). Research and development laboratories (no hazardous materials).

3. **Prohibited Uses.** Unless otherwise provided in this Title, land or buildings may not be used for the following uses:

- a. Abattoirs (slaughterhouses).
- b. Acid manufacture.
- c. Asphalt manufacture.
- d. Cement, lime, gypsum or plaster of paris manufacture.
- e. Explosive manufacture or storage.
- f. Fertilizer manufacture.
- g. Foundry.
- h. Garbage, rubbish, offal or dead animal reduction.
- i. Glue manufacture.
- j. Junk yards.
- k. LP Distributor.
- l. Mini-storage type Units.
- m. Paper mill.
- n. Petroleum refining.
- o. Residential.
- p. Sawmills.
- q. Sexually-oriented adult businesses.

- r. Smelting of ferrous and non-ferrous metal.
- s. Solid waste transfer stations.
- t. Stockyards.
- u. Tannery.
- v. Whey processing.

4. **Conformance to Codes.** Permitted uses shall be conducted within acceptable standards in local, state and national codes pertaining to noise, vibrations, smoke, toxic or noxious matter, odorous matter, fire and explosive hazards, glare or heat, air pollution, water pollution and maintenance of property.

5. **Land/Building Ratio.** No more than sixty percent (60%) of any site shall be covered surface pavement or other covering materials which are impervious to surface water absorption unless sufficient stormwater management practices are implemented to offset the impact of development beyond the standard. Prior to the issuance of a building permit, the Public Works Director will determine whether the stormwater management practices undertaken are deemed sufficient.

6. **Minimum Lot Sizes.** No platted parcel shall be further divided into parcels smaller than one (1) acre. In no instance shall such division create a parcel which is not developable in compliance with this ordinance or which would violate any applicable state or local laws, ordinances or regulations regulating the subdivision of lands.

7. **Setbacks.** The following yard or building setback requirements shall apply to all parcels that are located in the Gateway Business Park:

a. Commercial Setback. All commercial buildings, as defined above, shall have a setback minimum of twenty-five (25) feet from parcel lines abutting any public street.

b. Industrial Setback. All industrial buildings, as determined by the Wisconsin Department of Revenue taxation classification, shall have a setback minimum of twenty-five (25) feet from parcel lines abutting any public street.

c. Side Yard Setback. All buildings shall have a setback minimum of twenty (20) feet from any parcel line shared in common with another parcel owner within the Property and which joins a parcel line abutting a public street ("Side Yard Line"). Corner Lots shall be deemed to have two side lot lines. In the event that two adjoining sites shall be owned by the Grantee and in the improvement of such sites a building shall be erected on these combined sites, then the side yard requirements on the interior lines are waived.

d. Rear Yard Setback. All buildings shall have a setback minimum of twenty (20) feet from the rear lot line. In the event that two adjoining sites shall be owned by the same Landowner and in the improvement of such sites a building shall be erected on these combined sites, the rear yard requirements are waived.

e. Residential Buffer Zone Setback. All buildings that are located on parcels that abut a residential district shall have a forty (40) foot "buffer zone" setback minimum from any parcel line abutting the residential district.

8. Secondary Structures.

a. Accessory Structures. Accessory structures are permitted. Such structures shall be setback from front building line and otherwise meet the same setback requirements as the primary structure. Building materials, colors and roof lines shall be consistent with primary building.

b. Temporary Structures. No building or structure of temporary character shall be used on any lot at any time except for construction trailers during the period of construction. The use of cargo containers as a temporary storage facility is prohibited.

9. **Utility Control**. All utilities, including all electric power, telephone, gas, water, storm and sanitary sewers shall be located underground unless such location would prevent or detract from the utilization of renewable energy sources.

10. Building Design.

a. Landowners shall ensure that the scale and design of new buildings are compatible with adjacent buildings.

b. At pedestrian areas, the scale of the building should be lowered. Strategies include, but are not limited to, the use of awnings, landscaping, windows and doors.

c. Landowners shall locate utility meters and exhaust vents on the side or rear of building.

11. **Building Materials**. The following requirements shall apply to all parcels:

a. Exterior Walls. The exterior walls of each building shall be constructed of durable, permanent architectural materials.

b. Front Façade. At least thirty-three percent (33%) of the front facade and street side(s) facades shall incorporate brick, stone, architectural block, architectural concrete panels, architectural wood and/or glass into their design. Front facade materials shall be continued for not less than twenty (20) feet on each side from the front surface.

c. Pole Buildings. Pole buildings are permitted but must include sufficient architectural elements as described above in addition to roof overhangs, porches, windows that would enhance the overall attractiveness of the building. It is encouraged that pole buildings not exceed eighty (80) feet in width.

12. **Building Exteriors and Lighting.**

a. Except as otherwise provided herein, the sides and rear of all buildings shall be finished in an attractive manner in keeping with the accepted standards used for commercial and industrial buildings.

b. Breaking up large building sections with such elements as awnings, variable planes, projections, setbacks or changes in the roof line is encouraged.

c. All elevations of the building shall be designed in a consistent and coherent architectural manner. Changes in material, color and/or texture shall occur at points relating to the massing and overall design concept of the building.

d. HVAC and Miscellaneous Building Systems. Cooling towers, rooftop and ground-mounted mechanical and electrical units and other miscellaneous equipment shall either be integrated into the design of the building or screened from view from the primary public street unless doing so would prevent or detract from the utilization of renewable energy sources.

e. Building Lighting. Except for lighting near building access points and prominent architectural features, buildings should be darkened in the evenings to avoid 'glowing'. The size, scale and location of light and luminate should match site and building scale, color and theme.

f. Driveway, Sidewalk, and Parking Lot Lighting. Lighting shall be full cutoff luminaries which keep off-site overspill and night sky lighting to a minimum. Location of the fixtures shall emphasize intersections and pedestrian access routes yet provide a uniform level of illumination. Scale of fixtures shall be lowered in pedestrian areas to emphasize walking surfaces.

g. All outdoor lighting or nonresidential uses shall be designed, located and mounted so that the maximum illumination, as measured horizontally at the lot line, does not exceed 9.6 foot candles.

13. Parking, Driveways and Sidewalks.

- a. Parking Setbacks. Parking areas shall be located at least twenty-five (25) feet from any public street and at least ten (10) feet from any parcel line.
- b. On-site Parking Required. Parking shall be provided to sufficiently accommodate for employee and visitor vehicles. Employee, customer or visitor parking will not be permitted on public streets in the Gateway Business Park. Shared parking with adjacent property owners is encouraged.
- c. Minimum Parking Area. Total parking space shall be a minimum of one hundred and eighty (180) square feet per parking stall, excluding drives and approaches.
- d. Bike racks and/or storage shall be provided as needed to meet the demand of employees and visitors.
- e. Surfaces. All driveways, walks and permanent parking areas shall be surfaced with asphalt concrete, cement concrete or pervious pavers.

14. Loading and Storage Areas.

- a. Loading Docks. Shall not be located on sides of any building facing any public street. No loading or unloading shall be permitted on, or which results in obstruction of public streets; loading areas shall be hard surface paved and dust free. Pervious surfaces to allow water infiltration are also permitted.
- b. Outdoor Storage Provisions. Outdoor storage shall be limited to the rear two-thirds of the property and within building setback lines, be hard surface paved and dust free, and be screened from public view behind a visual barrier and be limited to the following permitted uses:
 - (i). Materials, supplies, merchandise, garbage dumpsters or equipment; or
 - (ii). Finished manufactured goods scheduled for delivery.
- c. Screening. Screening shall be attractive in appearance and in keeping with the architectural quality of the main structure. Screening methods – including fences, walls or hedges - may not extend forward of building setback lines.
- d. Oil and Bulk Fluids. Storage of fuel oil or other bulk fluids must be screened from public view, or on the rear two-thirds of the property.
- e. Finished manufactured goods for the purpose of sales or promotional display are not subject to the conditions set herein for Loading and Storage Areas.

15. **Landscaping.**

a. Approved Landscaping Plans. All unimproved areas of every site on which a building is constructed in the Gateway Business Park shall be landscaped in accordance with submitted plans. All landscaping, planting, etc. shall be done in suitable manner so that it will produce an acceptable appearance, excepting only those areas as may be required for driveways, visitor parking or walks. Plans shall include a landscape care and maintenance manual or plan to ensure long-term viability of plantings. All trees shall be from the list adopted by the Tree Board in accordance with Viroqua Municipal Code Chapter 8.36.

b. Setback Landscape. The setback area abutting streets shall be landscaped with a combination of deciduous canopy trees, shrubbery and ground cover. At least one tree at least six (6) feet in height for each thirty (30) feet of street frontage shall be planted in the setback area. Plantings in any public way shall comply with the requirements of Viroqua Municipal Code Chapters 8.36 and 12.12.

c. Buffer Zone Landscape. Any "buffer zone", shall be a minimum of forty (40) feet wide and planted with plant materials at least six (6) feet in height of such variety and growth habits as to provide a year-round, effective screen.

d. Parking Area Landscape. All on-site parking areas that serve twenty (20) vehicles or more shall be provided with landscape areas totaling not less than ten (10) percent of the surfaced area.

e. Landscaping Timeline. All landscaping shall be completed within ninety (90) days of issuance of a certificate of occupancy or similar document allowing occupation and use of such property by the governmental or public authority having jurisdiction thereof. If the certificate of occupancy is issued after October 1st of any given year, the landscaping completion date shall be June 30th of the following year.

16. **Stormwater Management.** All developments regardless of size shall meet or exceed the following performance standards:

a. Wisconsin Code NR 151 - Sub-Chapter III - Non-Agricultural Performance Standards.

b. Peak discharge shall meet pre-development rates for the 1 through 100-year design storm events based on NOAA Atlas 14 rainfalls.

c. All culverts shall be sized at a minimum to convey the twenty-five (25) year design storm event, with minimum diameter of fifteen (15) inches. All storm water conveyance channels must have a safe overland flow route that do not impact structures and minimize the inundation of roadways.

17. Property Maintenance.

a. Building Maintenance. The owner of any tract in the Gateway Business Park must at all times keep the premises, buildings, improvements and appearance in a safe, neat and clean condition and comply in all respects with all government, health and local policy requirements.

b. Waste and Refuse. The owner will remove at his or her own expense any rubbish of any character whatsoever which may accumulate on said property with the exception of ordinary city garbage collection. No waste material or refuse may be dumped or permitted to remain on any part of the property outside of the buildings.

Chapter 17.09

PLANNED UNIT DEVELOPMENT

Sections:

- 17.09.010 Purpose
- 17.09.020 Approval Process
- 17.09.030 PUD Lot Size and Project Size
- 17.09.040 General Development Plan (GDP) Procedure
- 17.09.050 PUD-GDP Contents
- 17.09.060 PUD-GDP Criteria for Approval
- 17.09.070 Effect of PUD-GDP Approval
- 17.09.080 Amending a PUD-GDP
- 17.09.100 PUD-SIP Procedure
- 17.09.110 PUD-SIP Contents
- 17.09.120 PUD-SIP Criteria for Approval
- 17.09.130 Effect of PUD-SIP Approval
- 17.09.140 Modifying a PUD-SIP

Section 17.09.010 Purpose. In return for greater flexibility in site design requirements, planned unit development (PUD) districts are expected to deliver exceptional quality community designs that preserve or enhance critical environmental resources, provide above-average open space amenities, incorporate creative design in the layout of buildings, open space, and circulation; assure compatibility with surrounding land uses and neighborhood character; and provide greater efficiency in the layout and provision of roads, utilities, and other infrastructure.

Section 17.09.020 Approval Process. PUD approval process contains two steps: a general development plan (GDP), which covers overall project intent and is the rezoning for the project; and a specific implementation plan (SIP), which contains the design details for the project. Procedures and contents for each step are detailed in this section. PUDs proposed with a single phase are encouraged to submit a concept plan, followed by a combined GDP-SIP application.

Section 17.09.030 PUD Lot Size and Project Size. The PUD project size should be large enough to establish a comprehensive site plan and coherence of design. However, smaller redevelopment projects may be considered when PUD zoning is required in order for a redevelopment project to fit in with its surroundings.

1. The minimum size for projects on undeveloped lots is two (2) acres.

2. There is no minimum lot size for redevelopment projects. The City Council finds that planned redevelopment projects, when undertaken at density levels that approximate or exceed historic density patterns, can prevent sprawl, conserve open space, achieve a sense of place, enhance amenities, and reduce public and private costs of development.

Section 17.09.040 General Development Plan (GDP) Procedure.

1. Concept Plan. Applicants who will be seeking PUD-GDP approval are encouraged to submit a concept plan for discussion by the Plan Commission prior to investing in production of a full PUD-GDP application. A concept plan shall be submitted ten (10) days prior to a Plan Commission meeting for placement on the agenda. The purpose of the concept plan shall be to familiarize the developer and the Plan Commission with each other's intentions with respect to the PUD. Any statements made by either the Plan Commission or the developer at this stage of the development process shall not be binding. While there are no requirements for submittal of a concept plan, the developer is encouraged to submit sufficient materials to allow the Plan Commission to learn the intent of the project and offer general feedback to the developer.

2. The applicant shall submit ten (10) copies of PUD-GDP text and plans required under Section 17.09.050 of this code at least fourteen (14) days prior to the Plan Commission meeting.

3. City staff shall review the application for completeness under Section 17.09.050. Should city staff determine the application to be complete, it shall be placed on the Plan Commission agenda and application forwarded to the Plan Commission. A determination of completeness by city staff shall not prevent staff, the Plan Commission, or the City Council from requesting clarification or further information on items provided under Section 17.09.050 of this code in order to better judge the application against the criteria for approval.

4. The Plan Commission shall set the date of the required rezoning public hearing and refer the application to any necessary committees for comment.

5. City staff shall complete a detailed review of the proposed GDP to determine whether the proposed development meets the criteria for approval and/or whether further information is required in order to make such a determination.

6. The Plan Commission shall hold a public hearing consistent with the rezoning procedure contained in this code. Subsequent to the public hearing the Plan Commission shall make a recommendation to the City Council. The Plan Commission may recommend approval of the GDP application, approval with conditions (such as addressing staff/committee comments), or denial. A recommendation to approve with conditions shall list any such conditions. A recommendation to deny the application shall list the reason(s) why denial is recommended.

7. Should any conditions require edits to the submitted plans, the developer shall submit ten (10) updated copies of the proposed GDP. These items shall be provided at least ten (10) days prior to City Council consideration of the GDP.

8. The City Council shall review all provided materials. The council may approve the GDP as submitted, approve the GDP with conditions, or deny the rezoning. An approval with conditions shall list any such conditions. If conditions require edits to submitted plans, the council shall either direct staff to determine whether the conditions have been met, or direct the developer to resubmit the proposal to the council for such a determination. A denial of the application shall state the reason(s) why the application was denied.

9. When approved by the City Council, a PUD-GDP shall be a new zoning district that replaces the existing zoning district or districts that had applied to the PUD-GDP area. The development standards and land uses in an approved development plan are the zoning regulations, standards, and land uses for a GDP in the PUD district. The city shall retain a file containing the approved PUD-GDP document. The official zoning map shall identify the area covered by each PUD district and label each such PUD in a manner that will reference the approved PUD-GDP document. Within fourteen (14) days of all City Council conditions of approval having been met, the applicant shall record a document with the county which specifies the property covered by the PUD-GDP and references the approved PUD-GDP document.

Section 17.09.050 PUD-GDP Contents. The following items shall be submitted by the applicant seeking rezoning to a PUD.

1. A cover letter, signed by the owner(s) of the property covered by the PUD proposal that summarizes the proposed development and requests rezoning to PUD-GDP.

2. A legal description of the total site proposed for rezoning to PUD. For unplatted lands, this description shall be a metes and bounds description. For platted lands, this description shall provide township and range location, lot/outlot numbers, volume number, page number, and document number as applicable.

3. A statement describing how the GDP complies with relevant goals, objectives, and policies from the comprehensive plan.

4. A statement describing the planning objectives and the character of the proposed development (including permitted land uses), and why use of PUD zoning is necessary to achieve the desired character. Permitted uses may reference other districts in this code.

5. If the development is to be built in phases, a development schedule indicating the anticipated commencement and completion of each phase. A staging map shall be provided for projects with more than two proposed phases. Long-term developments may provide a range of years for certain phases. Changes from the anticipated timing and order of phases shall not require amendment of the GDP, however, each phase shall be planned and built in such a manner that will not create undue hardship for residents and/or tenants of the PUD or the city as a whole, should future phases be delayed.

6. A chart summarizing proposed GDP density.

7. Square footage of proposed commercial or industrial uses compared to site area.

8. Number of residential units broken down by number of bedrooms and anticipated unit type (single-family, multifamily, condominium, multifamily-apartment) compared to site area.

9. A discussion of any proposed exemptions/exceptions from landscaping, signage, parking, lighting, and any other design related regulations contained elsewhere in this code and why such exemptions/exceptions are necessary or desirable (this does not include design-related regulations that are found under a single zoning district). If no such discussion is provided, it shall be assumed that the PUD will comply with all such regulations of the original zoning district that would otherwise be utilized to accommodate similar development.

10. An overall map of the project area, illustrating its relationship to surrounding properties.

11. A map showing contours in four-foot increments, the location and size of floodplains, wetlands, and other natural resource areas, noting which areas are to be preserved and which areas will be impacted by the proposed development.

12. A map showing the general location and size of common open spaces, public parks, recreational areas, school sites, and similar public and semi-public uses, noting where items in (11) above overlap. Provision shall be made for maintenance of semi-public open space that is held in common (such as open space owned by a condominium or by a neighborhood association).

13. A map showing the location, types, and density or intensity of proposed uses.

14. A map showing the general layout of street, pedestrian, and bicycle circulation systems, with accompanying diagrams of proposed street cross-sections.

15. A map showing the layout of public utilities, such as sanitary sewers, storm sewers, storm water management facilities, and water mains. The map shall be at a level of detail sufficient to illustrate that provision of sufficient public utilities to the site is possible and can be accomplished in accordance with proposed phasing, but need not be more detailed.

16. The city may require a Traffic Impact Analysis (TIA).

17. Any other information required by the Plan Commission that is deemed necessary to judge the proposal against the standards for approval, the intent of the PUD, and/or the city comprehensive plan.

Section 17.09.060 PUD-GDP Criteria for Approval. The following criteria shall be applied as a basis for determining the acceptability of a GDP.

1. Compliance with the city comprehensive plan and any other planning documents relevant to the area that have been adopted by the city.

2. Character and intensity of land use. The uses proposed and their intensity and arrangement on the site shall:

a) Respect the physical attributes of the site with particular concern for preservation of natural features, tree growth, and open space.

b) Produce an attractive environment of sustained aesthetic and ecological desirability, economic stability, and functional practicality compatible with existing development.

c) Not adversely affect the anticipated provision of school or municipal services.

d) Not create traffic or parking demand incompatible with the existing or proposed facilities to serve it.

3. The project will not adversely affect the economic prosperity of the city or the values of surrounding properties.

4. Engineering design standards. Streets and other ways, outdoor lighting, provision for storm water drainage, sanitary sewer service, water supply, or other similar environmental and municipal engineering considerations shall be based on appropriate standards necessary to implement the specific function and specific situation. In no case shall standards be less than those necessary to achieve the public health, safety and welfare as determined by the city.

5. Provision shall be made for the preservation and maintenance of open spaces either by public reservation or dedication or by commitment to preservation by a private entity, so as not to unduly burden existing park facilities.

Section 17.09.070 Effect of PUD-GDP Approval.

1. The approval of a GDP shall not authorize issuance of building permits. Building permits may only be issued after approval of the SIP.

2. Rezoning to PUD shall revert to prior zoning if a SIP for all or part of the previously approved GDP area is not submitted to the city within eighteen (18) months of City Council approval of the GDP. The landowner(s) or developer (with approval of the landowner) may apply to the City Council for extensions to the eighteen month period. The landowner(s) shall state the reason for the extension request. The City Council may approve or deny an extension at its discretion. An extension shall not be granted for longer than twelve (12) months at a time. Records of extensions shall be kept on file by the city.

Section 17.09.080 Amending a PUD-GDP. The process for amending a PUD shall be the same as the process for adopting a PUD-GDP under Section 17.09.040. The applicant shall resubmit a complete PUD-GDP with all the required elements under Section 17.09.050, plus a cover letter summarizing the changes between the originally adopted PUD and the proposed GDP amendment and the reasons for the proposed amendment.

Section 17.09.090 Specific Implementation Plan (PUD-SIP).

1. The developer may file a PUD-SIP after PUD-GDP zoning has been recorded with the county.

2. The area included in a SIP may be only a portion of the area included in a previously approved GDP.

3. If an SIP creates single-family or duplex lots, construction on such lots shall be reviewed by city staff to ensure consistency with: the previously approved GDP, the provisions contained within the SIP, and other relevant city ordinances. Review of site layout and design of single-family and duplex homes shall not be undertaken by the Plan Commission.

Section 17.09.100 PUD-SIP Procedure.

1. The applicant shall submit 16 copies of PUD-SIP text and plans required under Section 17.09.110 at least 21 days prior to the Plan Commission meeting.

2. City staff shall review the application for completeness under Section 17.09.110 to confirm that sufficient material has been submitted to review the application against the Criteria for Approval. Should city staff determine the application to be complete, it shall be placed on the Plan Commission agenda and forwarded to the Plan Commission and any necessary committees along with a report by city staff that details how the SIP complies with the previously approved GDP and how the criteria for SIP approval have been met. A determination of completeness by city staff shall not prevent the Plan Commission from requesting clarification or further information on items provided under Section 17.09.110.

3. The SIP shall be reviewed by the Plan Commission based on the criteria for approval in Section 17.09.120. The Plan Commission shall make a written recommendation to the City Council. The Plan Commission may recommend approval of the SIP application, approval with conditions, or denial. A recommendation to approve with conditions shall list the conditions. A recommendation to deny the application shall list the reason(s) of denial.

4. Any contracts or agreements, such as a development agreement, that the Plan Commission deems necessary, shall be prepared and forwarded to the City Council for consideration along with the SIP materials.

5. The City Council shall review all provided materials. The City Council may approve the SIP as submitted, approve the SIP with conditions, or deny the SIP. An approval with conditions shall list any such conditions. The City Council shall determine whether the conditions have been met. A denial of the application shall list the reason(s) why the application was denied. The developer shall submit a full plan set addressing all comments, which shall be kept on file by the city.

Section 17.09.110 PUD-SIP Contents.

1. Financing. Proof of financing capability pertaining to construction and maintenance of public improvement elements of the proposed development.

2. Consistency. Describing description of how the PUD-SIP is consistent with the previously approved GDP.

3. Plan Set. A plan set that shows the location, size and shape of the lot(s) involved; any proposed structures; and the existing and proposed use of each structure and lot; utilities to serve the development; and the existing and proposed contours of each lot. The Plan Commission may direct the developer to include a specific checklist of all relevant dimensions, square footages, structures, utilities, and any other improvements or changes being made to the property in question that must be shown in the plan set as part of the SIP application.

4. Erosion control and storm water management plan. Erosion control and storm water management plans meeting the requirements of NR 151 and NR 216 of the Wisconsin Administrative Code.

5. Lighting Plan. Proposed lighting for the site, including location, pole height, luminaire type, manufacturer's specifications, and pictures/diagrams of proposed fixtures.

6. Elevations. Color elevations of proposed buildings that illustrate and list proposed materials and colors. Elevations shall include necessary views to determine that all mechanicals, including rooftop mechanicals, are adequately screened to reduce both noise and visibility from ground level.

7. Other Materials. Section 17.09.110 shall be considered the minimum amount of information that must be provided to city to adequately compare the design review application with the standards contained in Section 17.09.120. Nothing herein shall prohibit the Plan Commission from requiring other materials or information as part of any SIP review process.

Section 17.09.120 PUD-SIP Criteria for Approval.

1. Consistency. The Plan Commission and City Council shall approve a PUD-SIP that is consistent with the previously approved PUD-GDP.

2. Appearance. No building shall be permitted to have a design or exterior appearance which is (in relation to its surroundings) unsightly or offensive to generally accepted taste and community standards. The City Council shall make necessary interpretations as to the substance of community standards.

3. Color. Color shall be selected in general harmony with the existing neighborhood or area buildings.

4. Facades, Generally. No blank walls shall face a public street, sidewalks, or other public spaces such as parks and plazas. Elements such as windows, doors, columns, changes in material, and similar details shall be used to add visual interest.

5. Mechanical, Heating, Ventilation, and Air Conditioning Equipment. All mechanical, heating, ventilation, and air conditioning equipment shall be located in a manner to be unobtrusive or screened from view. Ground-level equipment may be screened by landscaping. Rooftop equipment will not be readily visible when viewed from ground level from other properties or public rights-of-way and should be screened in a manner that fits with the overall building design and materials. Exterior mechanical equipment such as ductwork shall not be located on building facades that face the public right-of-way.

6. Traffic Circulation. Site plans shall provide for safe traffic circulation and safe driveway locations. Uses and structures that typically have frequent deliveries by large vehicles shall provide loading and unloading areas as necessary so as to not cause undue traffic hazards or congestion on city streets. The Plan Commission shall consider typical delivery patterns for similar businesses when determining what shall be required for an individual use or building.

7. Topography and Drainage. Buildings and uses shall maintain existing topography, drainage patterns, and vegetative cover insofar as is practical by minimizing soil and tree removal that is not essential to project development and by retaining grades and contours in keeping with the general appearance of neighboring areas.

8. Storm Water Management and Erosion Control. Appropriate storm water management and erosion control measures shall be utilized in all new construction as required by city ordinances and state law. Storm water management measures shall be well integrated with the landscaping plan and overall site design.

9. Outdoor Storage. Outdoor storage, service, or loading areas that are visible from adjacent residential uses or public streets and walkways shall be screened by a decorative fence, wall or plant material.

10. External Garbage and Refuse Containers. All external garbage or refuse containers shall be screened from the street and neighboring properties by walls, fences, berms, and/or effective landscaping.

11. Lighting. a) All outdoor lighting fixtures shall be cutoff-type fixtures. b) All outdoor lighting fixtures shall be placed so as to eliminate trespass greater than 0.5 foot-candles on the ground at the lot line. The Plan Commission may grant exceptions to this standard for uses in the commercial district that abut an adjacent commercial lot line. c) All outdoor lighting fixtures must be installed, maintained, and operated according to approved plans, including any restrictions on hours of use. d) No pole-mounted luminaire shall be taller than thirty-five (35) feet from ground level, except for lighting for athletic fields. e) Visible glare from beyond the property line is prohibited. 99 f) Building-mounted lights shall be mounted and installed so that all light is directed downward, unless the lighting is decorative in nature. g) No lights shall be mounted above the parapet, or for pitched roofs, above the eave, except for motion detection security lighting and decorative lighting. h) Decorative lighting is permitted, provided that lighting fixtures are aimed and shielded so that light is directed only onto the building façade and not towards adjacent properties or right-of-way.

Section 17.09.130 Effect of PUD-SIP Approval.

1. Building permits may be issued subsequent to City Council approval of the SIP and fulfillment of all conditions established by the City Council.

2. SIP approval lapses twelve (12) months after City Council approval if substantial development progress has not occurred. The landowner(s) or developer (with landowner's permission) may apply to Plan Commission for extensions to the twelve month period. The landowner(s) shall state the reason for the extension request. The City Council may approve or deny any extension at its discretion. An extension shall not be granted for longer than six (6) months at a time.

Section 17.09.140 Modifying a PUD-SIP.

1. Modifications to previously approved SIPs shall be considered minor or major modifications and shall be kept in the project's file.

2. Minor modifications. Minor modifications shall be considered administratively by the City Administrator. Denial of a minor modification may be appealed to the City Council. The following criteria shall be considered minor modifications to an approved SIP:

a) The modification will not significantly reduce any area of landscaping, open space, natural area, or parking.

- b) The change does not alter the density of the plan by more than ten (10%) percent (density shall be measured in square footage for commercial and industrial, and number of dwelling units for residential).
- c) The modification will not result in any structure, circulation, or parking area being moved significantly in any direction.
- d) The modification will not alter an approved setback by more than ten (10%) percent.
- e) The modification does not add any floors to the approved structure and does not change the height (in feet) of the structure by more than ten (10%) percent.
- f) The modification does not result in any significant adverse impacts beyond the site.
- g) The modification maintains the design intent or purpose of the originally approved development plan.
- h) The modification maintains the quality of design or product established by the originally approved SIP.
- i) The modification does not significantly alter the elevations of a previously approved structure with regard to materials, color scheme, or façade articulation.
- j) The modification complies with all relevant standards in this zoning code that may not be specific to the approved PUD-GDP or PUD-SIP (this may include landscaping, signage, lighting, or other standards).

3. Major modifications. All modifications that are not minor modifications shall be major modifications. Such modifications shall be approved, approved with conditions, or denied by the City Council. Conditions of approval shall be listed, and any reason(s) for denial shall be provided. Should the City Council determine that the SIP modification is so different from the originally approved SIP as to constitute a new proposal, the SIP shall be submitted for review by the Plan Commission and forwarded, with a recommendation, to the City Council for its consideration.

Chapter 17.12

ADMINISTRATION

Sections:

- 17.12.010 Building Inspector.
- 17.12.020 Changes and amendments.
- 17.12.030 Board of Appeals.
- 17.12.040 Enforcement: Violations and penalties.
- 17.12.050 Variance fee.

17.12.010 Building Inspector. There is hereby created the position of building Inspector, who shall have the powers and duties as outlined herein. This position shall be filled by appointment of the Mayor, subject to confirmation.

- A. Advise applicants as to the provisions of this ordinance and assist them in preparing permit applications.
- B. Issue permits and inspect properties for compliance with this ordinance and issue Certificates of Compliance when appropriate.
- C. Investigate, prepare reports and report violations of this chapter to the City Attorney.

17.12.020 Changes and Amendments. The City Council of the City of Viroqua may from time to time, alter, supplement or change the boundaries of districts and the regulations contained in this chapter in the manner provided by law.

17.12.030 Board of Appeals. There is hereby created a Board of Appeals, which may, in appropriate cases and subject to appropriate conditions and safeguards make special exceptions to the terms of this ordinance in harmony with its general purpose and intent and in accordance with general and specific regulations herein. It shall hold meetings and have power provided by the Wisconsin Statutes, 62.23(7).

17.12.040 Enforcement: Violations and Penalties. A. Any building or structure hereafter erected, moved or structurally altered or any use hereafter established in violation of any of the provisions of this ordinance shall be deemed an unlawful building, structure or use. The Building Inspector shall promptly report all such violations to the City Attorney, who shall bring action to enjoin the erection, moving or structural alteration of such building, or the establishment of such use or to cause building, structure, or use to be vacated or removed.

B. Any person, firm or corporation who violates, disobeys, neglects, omits, or refuses to comply with or who resists the enforcement of any of the provisions of this ordinance may also be required, upon conviction, to forfeit not less than \$10 and not more than \$500 for each offense, together with the cost of prosecution, and in default of payment, shall be imprisoned in the county jail of Vernon County until such forfeiture and costs are paid but not to exceed 30 days. Each day that a violation exists shall constitute a separate offense. Every violation of this chapter, is a public nuisance and may be enjoined and the maintenance thereof may be abated by action of suit of the City of Viroqua, the state or any citizen thereof.

C. The City, and any person who may be specially damaged in the event of any violation or threatened by any provision of this ordinance, may institute appropriate legal action to prevent such violation or to restrain, correct or abate such violation.

17.12.050 Variance Fee. An applicant for a variance shall pay a fee of \$75.00 at the time application is made to the City. (Ord. 460, 1996).

Chapter 17.16

DEFINITIONS

Section:

17.16.010 Definitions

ACCESSORY BUILDING OR USE includes a garage, a car port, a storage shed, and any other building, use or activity which is conducted or located on the premises of the principal use served, customarily incidental to, subordinate in purpose to, and clearly operated and maintained solely for the comfort, convenience, necessity, or benefit of the occupant, employee, customer, or visitor of or to the principal use.

ALLEY - An "alley" is a public or private right-of-way primarily designated to serve as secondary access to the side or rear of those properties whose principle frontage is on a street.

BUILDING is a structure built, used, designed, or intended for the support, shelter, protection, or enclosure of person, animals, chattels, or property of any kind, and which is permanently affixed to the land. When a building is divided into separate parts by unpierced walls extending from the ground up, each part shall be deemed a separate building.

BUILDING LINE/STREET SETBACK LINE . Minimum horizontal distance between an existing or proposed street right-of-way and the nearest point of a structure. The street setback of any lot or parcel abutting on a street shown as a proposed future street on the City's "Official Street Map" shall be measured from the proposed right-of-way line if different from the existing actual right-of-way line if different from the existing right-of-way.

CONDITIONAL USE - See: Use, Conditional

DEVELOPMENT. Any man-made change to improved or unimproved real estate, including but not limited to construction of additions or substantial improvements to buildings, other structures, or accessory uses, the placement of mobile homes, mining, dredging, filling, grading, paving, excavation or drilling operations, and deposition of materials.

DWELLING is a building, or portion thereof designed or used exclusively for residential occupancy, including single-family dwellings, two-family dwellings and multiple-family dwellings.

DWELLING UNIT. A house, apartment, group of rooms, or a single room occupied or intended for occupancy as separate living quarters. Separate living quarters are those in which the occupants do not share living facilities with any other persons in the structure and which quarters have direct access from the outside of the building or through a common hall. The occupants may be a single family or any group of related or unrelated persons who share living arrangements.

DWELLING. MULTIPLE. A dwelling containing (1) three or more dwelling units, and/or (2) a dwelling unit with any number of persons in excess of one family.

DWELLING. SINGLE FAMILY. A detached dwelling containing accommodations for and occupied by one (1) family only.

DWELLING. TWO FAMILY. A Dwelling designed exclusively for occupancy by two (2) families living independently of each other, and occupied by two (2) such families only.

FAMILY. An individual, or two or more persons related by blood, marriage, adoption, foster child arrangement, or similar legal relationship and functioning as a single housekeeping entity, or such individual or persons plus one individual not having such similar legal relationship but functioning as a part of the single housekeeping entity.

HALFWAY HOUSE/REHABILITATION CENTER/HOME FOR ADJUSTMENT is a use providing board and room, recreational, counseling, and other rehabilitation services to individuals, of either sex, or society adjustment problems requiring specialized attention and care in order to achieve personal independence. Individuals participating in a work release, or similar program from a state institution, and under the supervision of a county, state or local agency shall be included with this definition.

HOME OCCUPATION is any occupation or profession carried on by a member of the immediate family residing on the premises providing that such occupation is incidental to the use of the premises for residential purposes and does not effect any substantial change in the external arrangement of the buildings or in the character of the neighborhood; no substantial amount of stock in trade is kept or commodities sold, no person beyond the immediate family may be employed in said home occupation. A professional person may use his residence for consultation, emergency treatment, or performance of religious profession. home occupations are not permitted which involve the presence of any kind of animal, rodent or aquatic life on the premises as an essential part of such home occupation.

LOT is a parcel of land for which a legal description has been recorded at the office of the Register of Deeds.

LOT LINE, FRONT shall be that boundary of a lot which is along an existing or dedicated public street or, where no public street exists, is along a public way. The owner of a corner lot may select either street lot lines as the front lot line. In the case of the land-locked or partially land-locked land, the front lot line shall be that lot line that faces the access to the lot.

LOT LINE, REAR shall be that boundary of a lot which is most distant from, and is, or is most nearly, parallel to, the front lot line. If there be an alley abutting on a rear yard, the rear lot line shall be the center line of such alley. In case of irregular or triangular lots, where none of the lines bounding the rear of the lot are at an angle of less than 45 degrees to the front lot line, the rear lot line shall be line 15 feet long, within the lot, parallel to the front lot line or the main chord thereof, and at the maximum distance from the front lot line.

LOT LINE, SIDE shall be any boundary of a lot which is not a front lot line or a rear lot line.

LOT WIDTH is the horizontal distance from the side lot lines of a lot, measured at the narrowest width within the first 30 feet of lot depth immediately in back of the front yard setback line.

LOT, CORNER is a lot located at the intersection of two (2) streets or a lot bounded on two (2) sides by a curving street two (2) chord of which form an angle of one hundred twenty (120) degrees or less measured on the lot side.

LOT, DOUBLE FRONTAGE is a lot having frontage on two (2) non-intersecting streets as distinguished from a corner lot.

MANUFACTURED BUILDING - any structure or component thereof which is intended for use as a dwelling and:

1. Is of closed construction and fabricated or assembled on site or off site in manufacturing facilities for installation, connection or assembly and installation at the building site; or

2. Is building of open construction which is made or assembled in manufacturing facilities away from the building site for installation, connection, or assembly and installation on the building site and for which certification is sought by the manufacturer.

3. Is a building of open construction which is made or assembled in manufacturing facilities away from the building site for installation, connection, or assembly and installation on the building site and for which certification is sought by the manufacturer. The term manufactured building does not include building of open construction which is not subject to par. (a) 2. A single or double width mobile home is not considered a manufactured building.

MOBILE HOME is that which is, or was originally constructed, designed to be transported by any motor vehicle upon a public highway and designed, equipped and used primarily for sleeping, eating and living quarters, or is intended to be so used; and includes any additions, attachment, annexes, foundations and appurtenances.

MOBILE HOME PARK - a tract of land designed, maintained, or intended for the purpose of supplying a location or accommodations exclusively for one or more mobile homes, and upon which any mobile home, coach, or mobile home coaches are parked, and shall include all buildings used or intended for use as a park of the equipment thereof, whether or not a charge is made for the use of the mobile home park facilities. Mobile home parks shall not include automobile or mobile home sales lots on which unoccupied mobile homes are parked for the purpose of inspection, display and sale.

MOTEL - a combination or group of two (2) or more detached, semi detached or connected permanent dwellings occupying a building site integrally owned and used as a unit to furnish overnight transient living accommodations.

NON-CONFORMING USE is any use of land, building or structures, lawful at the time of the enactment of this ordinance, which does not comply with all of the regulation of this ordinance or of any amendment hereto governing use of the zoning districts in which such use is located.

ORDINARY HIGH WATER MARK - the highest point on the bank of a normal stage channel at which the water level has been for a sufficient period of time to leave a distinguishable mark including steam bans, limits of vegetation or other obvious indicators.

PARKING LOT is a building or premises containing one or more vehicle parking spaces excluding parking for single and two-family residence.

PARKING SPACE - an unobstructed and clearly marked 180 square foot area not counting turning, ingress and egress areas as determined by the Zoning Administrator. Each such parking space shall be located off the public street but accessible thereto. A loading space is not a parking space.

PERSON - "Person" means any individual, firm, association, corporation or body politic and includes any receiver, assignee or similar representative thereof.

PROFESSIONAL OFFICE - the office of a doctor, practitioner, dentist, minister, architect, landscape architect, professional engineer, lawyer, author, musician, or other recognized profession. Also see "Home Occupation, Professional Offices".

PUBLIC WAY is any sidewalk, street, alley, mall, highway, or other public thoroughfare.

SETBACK - the minimum horizontal distance between the street right-of-way line and the nearest point of a building.

SHOPPING CENTER - a retail center designed for the purpose of retailing and providing a wide range of goods and services of both the "convenience" and the "shoppers or durable" nature such as apparel, furniture and banking and financial service, for a trade area comprised

the entire community and extending beyond such center may include a number of separate businesses and stores within one or more structures under the ownership and management by one or more individual business and/or by a separate developer or corporation.

SIGN - a publicly displayed mark or symbol bearing some advertisement .

STRUCTURE - anything constructed, installed or erected, excluding surfacing and pavements.

USE - "Use" of property is the purpose or activity for which the land or building thereon is designed, arranged, or intended, or for which it is occupied or maintained. Accessory use shall be considered part of the principal use.

USE. ACCESSORY - see Accessory use.

USE, CONDITIONAL - is a use either public or private which, because of its special characteristics, cannot be allowed as a permitted use in a particular district or districts. After due consideration, in each case, of the impact of such use upon neighboring land such "conditional use" may or may not be granted, subject to the terms of this ordinance and the intent of the respective district.

USE. PERMITTED - is a use which may be lawfully established in a particular district or districts provided it conforms with all requirements, regulation, and standards of such district.

USE. PRINCIPAL - is the main use of land or buildings as distinguished from a subordinate or accessory use. A "principal use" may be "permitted" or "conditional".

UTILITIES - any public or private water, light, heat, or power supply, or waste collection and/or disposal system, including but not limited to, septic systems, private and public wells, and their attendant facilities, public sewage collection system and treatment facilities.

VARIANCE - a modification or variation of the provisions of this ordinance, as applied to a specific piece of property, except that modification in the allowable uses within a district shall not be considered a variance. Variances can be considered and granted by the Zoning Board of Appeals only.

VISION CLEARANCE - an unoccupied triangular space at the street corner of a corner lot which is bounded by the street lines and a setback line connecting points specified by measurement from the corner of each street line.

YARD is an open space on the same zoning lot with a building or structure, unoccupied and unobstructed from its lowest level to the sky. A "yard" extends along a lot line, and to a depth or width specific in the yard requirements for the zoning district in which such zoning lot is located.

YARD, REAR - a yard extending the full width of the lot between the rear lot line and the nearest part of the main building, excluding uncovered steps; provided that if there be an alley abutting on a rear yard, the rear lot line shall be the center line of such alley. In case of irregular or triangular lots, where none of the lines bounding the rear of the lot are at an angle of less than 45 degrees to the front lot line, the rear lot line shall be a line 15 feet long, within the lot, parallel to the front lot line of the main chord thereof, and at the maximum distance from the front lot line.

YARD, SIDE - a yard extending from the front yard, or the front lot line if there be no front yard, to the rear yard, being the minimum horizontal distance between a building and the side lot line.

Chapter 17.40SIGNSSections:

- 17.40.01 0 Preamble
- 17.40.02 0 Definitions
- 17.40.02 5 Computations
 - 17.40.030 Permits and Fees
 - 17.40.040 Design, Construction, and Maintenance
 - 17.40.050 Nonconforming Signs
 - 17.40.060 Violations and Remedies
 - 17.40.070 Appeals and Variances
 - 17.40.080 Design Review
- 17.40.09 0 Historic Signs
 - 17.40.120 Signs Allowed on Private Property
 - 17.40.140 Signs in the Public Right of Way
 - 17.40.150 Exempt Signs
- 17.40.16 0 Prohibited Signs
- 17.40.17 0 Electronic Variable Message Signs
 - 17.40.190 Conflict and Severability

Tables 1, 2, and 3
 Figures 1-13

17.40.010 PREAMBLE

1. Purpose. The purpose of this Sign Ordinance is to establish minimum standards for the City of Viroqua in order to maintain and enhance the aesthetic environment, to preserve the historic character and the scenic and natural beauty of the city including "Main Street", to minimize the possible adverse effect of signs on nearby public and private property, to improve pedestrian and traffic safety, and to permit the fair and consistent enforcement of these regulations through comprehensive and impartial standards. (Ord. 05OR006)

2. Scope and Applicability – Effect. A "sign" (as defined in this ordinance) may be erected, placed, established, painted, created, or maintained in the City only in conformity with this Ordinance. The intended effect of this ordinance as more specifically set forth herein, is:

a. To establish a permit system to allow a variety of types of signs in commercial and industrial zones and a limited variety of signs in other zones, subject to the standards and the permit procedures of this ordinance;

- b. To allow certain signs that are small, unobtrusive, and incidental to the principal use of the respective lots on which they are located, subject to the substantive requirements of this ordinance, but without a requirement for permits;
- c. To prohibit all signs not expressly permitted by this ordinance;
- d. To establish reasonable fees to recover the City's cost of administration of this ordinance;
- e. To provide for the enforcement of the provisions of this ordinance; (Ord. 05OR006)

17.40.020 DEFINITIONS

1. Interpretations. Words and phrases used in this Ordinance shall have the meaning set forth in this chapter. Words and phrases not defined in this chapter but defined elsewhere in the City zoning code, shall be given the meaning set forth there. All other words and phrases shall be given their common, ordinary meaning, unless the context clearly requires otherwise.

2. Definitions. For the purposes of this Ordinance, the following terms, phrases, words, and their derivations shall have the meaning given herein:

Awning. A type of hood or covering over doors or windows, constructed of flexible fabric or equivalent on a light metal frame which is adjustable or fixed.

Banner. A sign of light-weight, non-illuminated fabric or similar material that is mounted to a pole or a building at one or more edges; usually used for temporary display such as special announcement of a coming event.

Beacon. A stationary or revolving light which flashes or projects illumination, single color or multi-colored, in any manner which is intended to attract or divert attention; except, however, this term is not intended to include any kind of lighting device which is required or necessary under the safety regulations described by the Federal Aviation Administration or similar agencies.

Building Frontage. The distance for which a building is parallel or nearly parallel to the abutting street.

Building Inspector. An agent of the City of Viroqua authorized to permit, inspect, approve, or deny construction within the City.

Building Marker. Any sign indicating the name of the building and date and incidental information about its construction, which sign is cut into a masonry surface or made of bronze or other permanent material.

Commercial Message. Any sign wording, logo, or other representation that, directly or indirectly, names, advertises or calls attention to a business, product, service, sale or sales event or other commercial activity.

Design Review Board. A board that shall be formed for the purpose of reviewing sign permit applications. See 17.40.080 (4) for details of the Design Review Board organization.

Flag. Any fabric, banner, or bunting containing distinctive colors, patterns, or symbols, used as a symbol of government, political subdivision, or other public entity.

Historic Sign. Historically and architecturally significant signs that create a particular historic character on buildings or in areas of historic significance (i.e., historical theater, carnival, fair settings, etc.) as determined by the Historic Preservation Commission (see section 17.40.090).

Main Street Program Area. An area bounded on the south by South Street, on the west by Rock Avenue, on the east by Center Street, and on the north by Broadway Street.

Multiple Occupancy. A building occupied by a single occupant who engages in more than one activity within the building or which contains 2 or more activities engaged in by different occupants.

Mural. Of or pertaining to a wall; on or in a wall; as mural paintings. Noncommercial images of an aesthetic, illustrative, or decorative nature painted on a wall or affixed to a wall.

Nonconforming Sign. Any sign that does not conform to the requirements of this ordinance, but was legal at the time this sign ordinance was enacted.

Pennant. Any lightweight flexible plastic, fabric, or other material, whether or not containing a message of any kind, suspended from a rope, wire, or string usually in series, designed to move in the wind.

Premises. The contiguous land in the same ownership or control which is not divided by a street or other public right of way. The words "parcel", "property", "site" and "lot" shall have the same meaning as premises.

Principal Building. The building in which is conducted the principal use of the premises on which it is located. Premises with multiple principal uses may have multiple principal buildings, but storage buildings, garages, and other clearly accessory uses shall not be considered principal buildings.

Reflective Material. A material designed to reflect light directed to it for the purpose of night-time visibility without self illumination.

Roofline. The top of the building wall or the top of the parapet; for buildings with sloped roofs: whichever forms the top line of the building silhouette, excluding any minor projections such as chimneys.

Setback. The distance from the property line to the nearest part of the applicable building, structure, or sign, measured perpendicularly to the property line.

Sign. A "sign" is everything publicly displayed which bears information, including, without limitation because of enumeration, every device, fixture, placard, or structure using any color, form, graphic, illumination, symbol, or writing; and also including every structure which has been used as part of a sign, or erected to be used as part of a sign.

Types of signs mentioned in this ordinance include the following:

Abandoned. A sign which no longer correctly directs or exhorts any person, advertises a bona fide business, lessor, owner, product or activity conducted, or product available on the premises where the sign is displayed.

Animated. Any sign that uses action or motion of the entire sign or any of its parts, or change of lighting, but not including flashing signs, either natural or artificial, to depict action or create a special effect or scene. (06OR011)

Awning. Any sign that is a part of or attached to an awning.

Building. Any sign attached to any part of a building, as contrasted to a freestanding (ground) sign.

Canopy. Any sign that is a part of or attached to a canopy, marquee, or other structural protective cover over a door entrance, window, or outdoor service area.

Changeable Copy/Reader Board. A sign or portion thereof either permanently mounted or on a portable stand, with characters, letters, or illustrations that can be changed or rearranged by manual replacement without altering the face or the surface of the sign.

Double faced. A sign having 2 faces separated by not more than 3.5 feet, each face being of equal area and identical proportions to the other with each face located on the sign structure so as to be exactly opposite the other.

Electronic Variable Message. A sign which may be electrically, electronically or mechanically controlled and capable of showing a series of different messages in sequence (e.g., time, temperature, date, or changing messages).

Face. The surface or plane of the sign upon, against, or through which a message is displayed or illustrated.

Flashing. Any internally or externally illuminated sign on which artificial or reflected light is not maintained stationary and/or constant in intensity and/or color at all times when in use. (06OR011)

Freestanding. Also known as: Ground. A sign which is not attached to or a part of a completely self-supporting structure (a free standing frame, mast, or pole, or more than one such mast or pole). The supporting structure shall be set firmly in or below the ground surface and shall not be attached to any building or any other structure whether portable or stationary.

Identification. A sign that identifies the street number and when appropriate, the name of the building.

Illuminated. Any sign which has characters, letters, figures, designs, or outline illuminated internally or externally by artificial means, whether from within or from a light source located outside the sign, whether such outside lighting is attached, affixed, or independent from the sign.

a) Internal. Any sign designed to give any artificial light directly through any transparent or translucent material from a source of light originating within or on such sign.

b) External. Illumination so arranged that the light is reflected from the sign to the eyes of the viewer. A sign artificially illuminated other than an internally illuminated sign.

Incidental. A sign, generally informational that has a purpose secondary to the use of the premises on which it is located, such as "no parking," "loading only," "telephone," and other similar directives. No sign with a commercial message legible from a position off the premises on which the sign is located shall be considered incidental.

Off Premises. A sign which directs attention to a business, commodity, product, service, activity, entertainment or attraction sold, offered, or existing elsewhere than upon the same premises where such sign is displayed. The term off premises sign shall include an outdoor advertising sign (billboard) on which space is leased or rented by the owner thereof to others for the purpose of conveying a commercial or noncommercial message.

On Premises. A sign which directs attention to a business, commodity, product, service, activity, entertainment, or attraction sold, offered, or existing on the same premises where such sign is displayed; provided, an on premises sign may also display a noncommercial message.

Portable. Any sign not permanently attached to the ground or other permanent structure, or a sign designed to be transported, including, but not limited to, signs designed to be transported by means of wheels; signs converted to A or T frames; menu and sandwich board signs; balloons used as signs, umbrellas used for advertising; and signs attached to or painted on vehicles parked and visible from the public right-of-way, unless said vehicle is used in the normal day-to-day operation of the business.

Projecting. Any sign that shall be affixed at an angle or perpendicularly to the wall of any building in such a manner to read perpendicularly or at an angle to the wall on which it is mounted and projects more than 12 inches from a building.

Roof. A sign erected upon or above any portion of the roofline or parapet wall of a building, and which is wholly or partially supported by said building. A sign painted upon the roof of a structure.

Suspended. A sign that is suspended from the underside of a horizontal plane surface and is supported by such surface.

Temporary. Any sign that is not permanently attached to a building or the ground and which is intended to be displayed for a limited period of time. All of the following signs shall be considered temporary signs and shall meet the requirements for temporary signs:

1. Promotional and special event banners.
2. Signs erected in conjunction with the construction or remodeling of a building.
3. Election campaign signs.
4. Inflatable signs and tethered balloons.
5. Open house and grand opening signs.
6. Outdoor sale signs.
7. Portable signs.
8. Real estate sale or lease signs.
9. Temporary window signs.
10. Garage and rummage sale signs.

Wall. Any sign that shall be affixed parallel to the wall or printed on the wall or painted on the wall of any building in such a manner as to read parallel to the wall on which it is mounted; provided, however, said wall sign shall not project above the top of the wall or beyond the end of the building nor extend more than 12 inches from the building structure. A sign mounted upon a sloped roof of a commercial building which is an integral part of the design of such roof and building, and does not project above the roof line shall be considered a wall sign.

Window. Any sign, pictures, symbol, or combination thereof, designed to communicate information about an activity, business, commodity, event, sale or service that is placed inside a window or upon the window for purposes of viewing from outside the premises.

Sign Districts. For the purposes of this ordinance City Zoning districts are grouped into the following "Sign Districts".

1. Residential Sign District.

- A-1 Agricultural Transition District
- C-1 Conservancy District
- R-1 Single and Two-Family District
- R-2 Multiple Family Residence District
- R-3 Mobile Home Park District

Premises located in any other nonresidential zoning district where the principal use is residential will be governed by the regulations of this sign district.

2. Commercial Sign District.

- B-1 Central Business District
- B-2 Commercial District

3. Industrial Sign District.

- B-3 Industrial District
- B-4 Industrial Park

4. Institutional Sign District. Rules applicable to this sign district apply on all premises that contain schools (public and private; K-12 and post high school institutions) and/or Churches, regardless of zoning district.

Street Frontage. The distance for which a lot line of a parcel adjoins a public street, from one lot line intersecting said street to the furthest distant lot line intersecting the same street.

Structure. Any structure or material which supports, has supported, or is capable of supporting or helping maintain a sign in a stationary position, including braces, guys, and decorative covers.

Structural alteration. Includes, but is not limited to, the following: to relocate, replace, expand, enlarge, reposition, raise, heighten or illuminate. Structural alteration does not include repainting, cleaning, and other normal maintenance or repair of a sign or sign structure or change of message on the face of a sign.

Vision Triangle. The area formed by measuring from the intersection of 2 property lines at the intersection of 2 streets to points 25 feet along said property lines and then connecting these 2 points with a straight line. (Ord. 05OR006)

17.40.025 COMPUTATIONS

1. Sign Area. The area of a sign shall be computed by means of the smallest rectilinear figure which encompasses all lettering, wording, frame, design or symbols, together with any background and any illuminated part of the sign on which the sign is located, if such background or such illuminated part of the sign is designed as an integral part of and related to the sign. Supports and bracing which are not intended as part of the sign and which contain no message, shall be excluded.
2. Sign Area for multi -faced signs. If the sign consists of more than one face, the area of all faces shall be totaled, except that when two sides of a double faced sign display identical messages or other representation, the gross area shall include only one of the sides.
3. Sign Height. The height of a sign shall be the vertical distance measured from the ground where the sign is located to the highest attached component of the sign, including any filling, berming, mounding, or excavating solely for the purpose of locating the sign. (Ord. 05OR006)

17.40.030 PERMITS AND FEES

1. Permits Required. No person shall erect or structurally alter any sign, except those specifically exempted by this Chapter without a permit from the Building Inspector, which shall be issued only after written application on a form prepared by the Building Inspector if the sign complies with all of the provisions of this chapter and payment of a fee as provided herein. The application shall be accompanied by such scale drawings (including, but not limited to site plan, structural details), photographs and other information as the Building Inspector may reasonably require. If the sign owner (for example, a building tenant) is different than the property owner the permit shall be signed by both parties.
2. A sign permit shall become null and void when the work authorized by the permit has not been accomplished within 120 days of the issuance of the permit.
3. Fees. The fee for a sign permit shall be \$25 for a sign which costs less than \$5,000, and an additional fee of \$1 per \$1,000 cost, or part thereof, in excess of \$5,000.
4. A permit is not required for normal maintenance or repair of a sign or change of message that does not structurally alter the sign. See definition for structural alteration.
5. Any person who erects a sign without a permit when a permit is required by this chapter shall be required to forfeit twice the amount of the applicable fees. (Ord. 05OR006)

17.40.040 DESIGN, CONSTRUCTION AND MAINTENANCE

1. Design Construction and Maintenance. All signs shall be designed, constructed and maintained in accordance with the following standards:
 - a. All signs shall comply with applicable provisions of the Wisconsin Building Code and the National Electric Code.
 - b. Except for temporary signs, all signs shall be constructed of permanent materials and shall be permanently attached to the ground, a building, or another structure by direct attachment to a rigid wall, frame, or structure, and shall be maintained in good finished (not faded) and good structural condition at all times; able to withstand 30 psf of wind pressure. Freestanding steel sign structures that exceed 12 feet in height shall be designed to be unbolted at their foundation.
 - c. Signs shall not cover or obstruct doors and windows.
 - d. In addition to the setback requirements in this ordinance, all signs shall be located such that there is at every street intersection a clear view between heights of 2 feet and 10 feet in the vision triangle. Signs located closer than 15 feet from the right of way and 15 feet from the edge of a driveway shall maintain a clear view between heights of 2.5 feet and 8 feet.
 - e. All signs shall meet minimum standards of professional quality in design, construction and maintenance.
2. Abandoned signs. All signs shall be removed by the owner or lessee of the premises when the business on the property has not been conducted for a period of 3 months. (Ord. 05OR006)

17.40.050 NONCONFORMING SIGNS

1. A sign other than a temporary sign that would be permitted under this Chapter only with a sign permit but which was in existence on the effective date of this ordinance, or on the effective date of any applicable amendment thereto, or on a later date when the property is annexed to the City, and which was constructed in accordance with this Chapter and other applicable laws in effect on the date of its construction, but which by reason of its size, height, location, design, or construction is not in conformance with the requirements of this Chapter, shall be allowed to remain in place.
2. Such signs, which were made nonconforming by the adoption of this Chapter, or as amended, shall be allowed to remain in place, provided that no action is taken which increases the degree or extent of the nonconformity. A change in the information on the face of an existing nonconforming sign is allowed.

3. A nonconforming sign shall not be re-established after damage or destruction if such damage to the sign exceeds 50 percent of its original construction cost or current replacement cost, whichever is less. The extent of the damage shall be determined by the Building Inspector.

4. Nonconforming animated and flashing signs. Signs that contain flashing, animated or moving parts are allowed to remain, provided that those parts are disabled within 6 months of the adoption of this ordinance. (Ord. 05OR006)

17.40.060 VIOLATIONS AND REMEDIES

1. Any of the following shall be a violation of this Chapter and shall be subject to the enforcement remedies and penalties provided by this Section, by the Zoning Ordinance, and by State law:

- a. To erect or maintain any sign in a way that is inconsistent with any plan or permit governing such sign or the premises on which the sign is located;
- b. To erect or maintain any sign requiring a permit without such a permit;
- c. To fail to remove any sign that is installed, created, erected, or maintained in violation of this Chapter; or
- d. To continue any such violation. Each day that each sign is in violation shall be considered a separate violation.

2. Remedies. Any sign erected or structurally altered in violation of this Chapter shall be removed by the owner or brought into compliance within 30 days of written notification by the building inspector. If the owner does not remove or bring into compliance, the City may cause removal to be executed. All costs of such removal shall be collected as a special assessment on the next succeeding tax role. (Ord. 05OR006)

17.40.070 APPEALS AND VARIANCES

1. Appeals may be made to the Zoning Board of Appeals by the same rights and procedures governing other zoning appeals. Appeals shall be reviewed by the Building Inspector who shall provide findings and advice to the board prior to its decision.

2. Specific variances from the terms of this Chapter may be granted where by reason of exceptional topographic conditions or other extraordinary and exceptional situation or conditions on a piece of property, the strict application of this ordinance would result in peculiar, exceptional, and undue hardship. Variances shall not be considered for off premise signs. (Ord. 05OR006)

17.40.080 DESIGN REVIEW

1. Before the issuance of a sign permit within the Commercial, Industrial or Institutional Sign Districts, the Design Review Board shall have an opportunity to review the application. The review board may approve, deny, or require changes to the proposed sign based upon the standards in paragraph 3 and the Design Review Guidelines. Upon approval, the Design Review Board will issue a Certificate of Appropriateness.

2. The intent of design review is to promote signage that is aesthetically pleasing; advances the purposes of this chapter; complements the goals of the Main Street Program; protects the historic architecture within the program area; and preserves the pedestrian scale of the program area. Applicants are encouraged to obtain a copy of the Sign Design Guidelines and to coordinate with the review board early on in the design phase.

3. Sign proposals will be reviewed in the context of Sign Design Guidelines to be established by the Design Review Board, maintained by the Building Inspection office, and based on the following standards and other relevant factors:

- a. Appropriate placement of signs on buildings.
- b. Appropriateness to surrounding architecture, setting, and neighboring signage.
- c. Promotion of business through quality, attractive, economical signage.

Additional standards applicable to the Main Street Program Area:

- d. Emphasis on business name and logo as opposed to advertising of name brands.
- e. Signage that is scaled to pedestrians and slowly moving traffic.
- f. Internally lit box signs are discouraged as being out of character with the traditional appearance of Main Street.

4. The Design Review Board shall be organized as follows:

- a. Annually, no later than May 1, the Viroqua Chamber Main Street shall appoint a chairperson. The chairperson shall vote only to break a tie.
- b. Annually, no later than May 1, the Viroqua Chamber Main Street Board of Directors and the Historic Preservation Commission shall each appoint two (2) individuals to serve on the Design Review Board. The Design Review Board shall organize annually, no later than May 15 and appoint one city resident member. The resident member should have artistic, graphic design or architectural aptitude, background or experience.
- c. Agendas shall be posted, and meetings shall be conducted in accordance with Wisconsin open meetings procedures, including recording minutes of the meetings. (16 OR 007)

5. The Design Review Board shall act upon the application within 10 working days. If approved, a Certificate of Appropriateness will be issued and the Building Inspector may issue the permit. If not approved, the Design Review Board will submit a written explanation as to why the application was denied, and/or what changes need to be done to conform to the provisions of this ordinance.

Appeals. Appeals shall be made to the Zoning Board of Appeals by the same rights and procedures governing other zoning appeals. The Zoning Board of Appeals reserves the right to seek the advice of the Design Review Board for any appeals. (Ord. 05OR006)

17.40.090 HISTORIC SIGNS

1. Historic signs. Within 6 months of the adoption of this ordinance the Historic Preservation Commission shall submit to the City Building Inspection Department a list of individual historic signs, which shall constitute the permanent record of historic signs in the City. After that time, only an in-place sign uncovered in restoration work or a sign on a property annexed to the City shall be eligible for designation as a historic sign. For a sign to be designated historic it must:

- a. have existed continuously in its current location or proximate thereto since 1950;
- b. be an appurtenant graphic;
- c. be unique and enhance the cultural, historical, or aesthetic quality of the City; and
- d. be structurally sound.

2. Historic signs shall not count against the maximum allowable signage on the premises and shall be exempt from other provisions of the ordinance that would not normally permit the placement of that sign in that location. (Ord. 05OR006)

17.40.120 SIGNS ALLOWED ON PRIVATE PROPERTY

1. Permanent Signs. The following signs whose subject matter relates exclusively to the premises on which they are located, or to products, accommodations, or activities on those premises (on premise signs), shall be allowed as follows:

a. Permanent signs shall be allowed on private property in the City only in accordance with, Table 1. If the letter "A" appears for a sign type in a column, such sign is allowed without prior permit approval in the sign districts represented by that column. If the letter "P" appears for a sign type in a column, such sign is allowed only with prior permit approval in the sign districts represented by that column; special conditions may apply in some cases. If the letter "N" appears for a sign type in a column, such sign is not allowed in the sign districts represented by that column under any circumstances.

b. Although permitted under Table 1, a sign designated by an "A" or "P" shall be allowed only if it complies with the requirements for size, location, number and other characteristics in:

1) Table 2 (Number and dimensions of certain individual signs by sign type), and Table 3 (Permitted sign characteristics by sign district); and

2) Figures 1 – 12

2. Temporary Signs. With the exception of banners, no temporary sign shall exceed 16 square feet. Temporary signs shall meet all setback requirements. The following temporary signs are allowed, for the time period listed; for permit requirements see Table 1:

a. Banners: Promotional and special event banners shall be erected no more than 30 days prior to the event and must be removed within 5 days after the event.

b. Construction signs: One unlighted sign of up to 16 square feet (8 square feet in the residential sign district) identifying parties involved in construction on the premises where the sign is located. The sign must be removed within 7 days after substantial completion of construction. Signs announcing "Future site of..." fall in this category, as do subdivision development signs.

c. Campaign signs: Campaign signs may not be erected sooner than 45 days before any election and must be removed within 5 days after any election. Signs shall not exceed 16 square feet (8 sq. ft. in the residential sign district).

d. Real estate signs: One unlighted sign of up to 16 square feet (8 square feet in the residential sign district) pertaining to the sale, rental or lease of the premises on which the sign is displayed; to be removed within 14 days after sale, rental or lease.

e. Portable signs: No more than one sign per premises, not to exceed 16 square feet (8 square feet in the residential sign district); limited to 30 days. Signs may not be illuminated.

f. Garage sale signs: Signs of up to 6 square feet, displayed on private property, not to exceed 5 consecutive days.

g. Display window signs: The inside surface of any ground floor window may be used for attachment of temporary signs.

h. Other non illuminated signs that meet the definition of a temporary sign. (Ord. 05OR006)

17.40.140 SIGNS IN THE PUBLIC RIGHT OF WAY

No signs shall be allowed in the public right of way, except the following:

1. Permanent signs:

- a. Public signs erected by or on behalf of a governmental body to post legal notices, identifying public property, convey public information, and direct or regulate pedestrian or vehicular traffic.
- b. Informational signs of a public utility regarding its poles, lines, pipes, or facilities.
- c. Signs projecting over a public right of way where the street setback requirement is zero, such as in the B-1 Central Business District, in conformity with this Chapter.

2. Temporary signs: Temporary signs as permitted in Table 1.

3. Emergency signs: Emergency warning signs erected by a governmental agency, a public utility company, or a contractor doing authorized or permitted work within the public right of way.

4. Other Signs Forfeited. Any sign installed or placed on public property, except in conformance with this Chapter shall be forfeited to the public and subject to confiscation. In addition to the other remedies hereunder, the City shall have the right to recover from the owner or person placing such a sign the full costs of removal and disposal of such sign. (Ord. 05OR006)

17.40.150 EXEMPT SIGNS

The following signs shall be exempt from regulation under this Chapter:

1. Any public notice or warning required by a valid and applicable Federal, State, or local law, regulation, or ordinance;
2. Any sign inside a building, not attached to a window or door, that is not legible from the lot line of the premises on which the sign is located;
3. Murals.
4. Holiday lights and decorations with no commercial message;
5. Traffic control signs on private property, such as Stop, Yield, and similar signs, the face of which meet Department of Transportation standards and which contain no commercial message.
6. Signs located within the Vernon County Fairgrounds not intended to be viewed from off of the grounds. (Ord. 05OR006)

17.40.160 PROHIBITED SIGNS

All signs not expressly permitted under this Chapter or exempt from regulation in accordance with the previous section are prohibited in the City. Such signs include, but are not limited to:

1. Signs painted on, attached to, or supported by a tree, stone, cliff, or other natural object.
2. Signs painted directly onto brick building walls.
3. Signs placed upon metal light poles, utility poles, stop signs, or traffic signs.
4. Signs that contain flashing, animated, or visible moving parts. Traditional barber poles are allowed.
5. Signs utilizing spotlights which are directed at motorists or adjacent properties, and illuminated signs whose light source is positioned so that the light beam is directed onto adjacent properties or roadways. Beacons.
6. Signs that purport to be or are an imitation of, or resemble an official traffic sign or signal, or which bear the words "stop", "go slow", "caution", "warning", or similar words that are displayed in the colors normally associated with them as official signs.
7. Roof signs.
8. Electronic Variable Message Signs, except displays limited to time and temperature.
9. Freestanding signs that extend or project over any building, canopy or roof.
10. Signs that contain reflective material. Incidental signs that direct traffic and do not exceed 6 square feet in area may contain reflective material.
11. Use of a vehicle or trailer as a sign in circumvention of this ordinance.
12. Over the street banners.
13. Signs that make noise by mechanical, electrical, or wind pressure means. (Ord. 05OR006)

17.40.170 ELECTRONIC VARIABLE MESSAGE SIGNS

1. Electronic variable message signs are prohibited in the "Historic District" which for purposes of this section means the area bounded by Rock Avenue, Center Avenue, Gillette Street, and South Street.
2. A permit for an electronic variable message sign may not be granted unless the sign meets all other requirements of this Chapter and the following additional requirements:
 - a. The height cannot exceed 22 feet;
 - b. No flashing lights;
3. A permit to install and maintain an electronic variable message sign may be granted only as a conditional use. The objectives which the conditions are intended to accomplish are the following:
 - a. Degree of use of the sign, if any, after normal business hours (10 PM to 6 AM) – limited or minimal use is preferred, e.g., static display, time and temperature, etc;
 - b. Degree of use of graphics – less is better;
 - c. Degree of use of multiple colors – less is better;
 - d. Frequency of change of message – State WisDoT standard sets minimum;
 - e. Effect of the sign with respect to other land uses within 100 feet; and
 - f. Other extenuating or special circumstances.
4. The Plan Commission shall hold a public hearing following appropriate legal notice and conduct a discussion of the pertinent factors, including but not necessarily limited to those listed above. The Plan Commission shall prepare a written report of its recommendations regarding the terms of the conditional use permit to be presented to the Council. (060R011)

17.40.190 CONFLICT and SEVERABILITY

1. Conflict. If any part of this ordinance is found to be in conflict with any other ordinance or any other part of this ordinance, the most restrictive or highest standard shall prevail.
2. Severability. If any section, subsection, sentence, clause, phrase, or portion of this ordinance or its application to any person or circumstance is held invalid by the decision of any court of competent jurisdiction, the remainder of this ordinance, or the application of the provision to other persons or circumstance is in effect and shall remain in full force and effect.
3. Protection of First Amendment Rights. Any sign, display, or device allowed under this ordinance may contain, in lieu of any other copy, any otherwise lawful noncommercial message that does not direct attention to a business operated for profit or to a commodity or service for sale, and that complies with all other requirements of this ordinance. (Ord. 05OR006)

**Table 1 – PERMITTED SIGNS
BY TYPE AND SIGN DISTRICT**

A = Allowed without permit P = Permit Required N = Not Allowed

	<u>Residential</u>	<u>Commercial</u>	<u>Industrial</u>	<u>Institutional</u>
<i><u>Freestanding Signs (a)</u></i>				
Freestanding	A(b)	P	P	P
Incidental	A(c)	A	A	A
<i><u>Building Signs (a)</u></i>				
Building Marker (e)	A	A	A	A
Canopy	N	P	P	P
Identification (d)	A	A	A	A
Incidental	A(c)	A	A	A
Projecting	N	P	P	N
Roof	N	N	N	N
Suspended	A	P	P	P
Wall	A(b)	P	P	P
Window	N	P	P	N
<i><u>Temporary Signs (f)</u></i>				
Banner	A	A	A	A
Construction	A	A	A	A
Election Campaign	A	A	A	A
Garage/Yard Sale	A	A	A	A
Portable	N	A (g)	A	A
Real Estate	A	A	A	A
<i><u>Miscellaneous</u></i>				
Flags	A	A	A	A

- (a) Except for incidental signs, premises must contain a principal building in order to be permitted a sign.
- (b) Any commercial message is restricted to an activity legally conducted on the premises.
- (c) No commercial message allowed on sign.
- (d) Only address and/or name of occupant allowed on sign.
- (e) May include only building name, date of construction, or historical data on historic site; must be cut or etched into masonry, bronze or similar material.
- (f) The conditions of 17.40.120, 2 "Temporary Signs" apply.
- (g) Portable signs are allowed on the public sidewalk only in the B-1 district on the following conditions: with permission of abutting property owner, one sign per ground level occupant, max. 6 sq. ft. in size, allowed during business hours, may not obstruct pedestrians, and may not be illuminated. (Ord. 05OR006)

**Table 2 – NUMBER AND DIMENSIONS OF CERTAIN INDIVIDUAL SIGNS
BY SIGN TYPE**

--- = Not Applicable

	Number Allowed	Maximum Signage Area (sq. ft.)	Maximum Projection From Building	Vertical Clearance
Awning	---	25% of awning area	---	---
Building Marker	1 per street frontage	4	---	---
Canopy	---	25%(a)	---	---
Flags	---	(c)	---	---
Identification	1 per occupancy	2	---	---
Incidental (b)	As required	6	---	---
Projecting	1 per ground floor occupancy	16	5 ft.	8 ft.
Suspended	1 per ground floor occupancy	6	---	8 ft.
Wall	---	50 (B-1 district) 200 (B-2 district)	---	---
Window	---	25% of window area	---	---

(a) Of vertical surface of canopy.

(b) The following types of signs in commercial zones shall be considered incidental signs: drive-thru and similar restaurant menu boards; graphics that are an integral part of vending and similar types of machines; and illuminated 'open' signs in ground floor windows.

(c) Residential sign districts: Flags shall not exceed 24 sq. ft.. or be flown from a flagpole more than 25 ft. in height. Other sign districts: Flags shall not exceed 40 sq. ft. or be flown from a pole more than 40 ft. in height. (Ord. 05OR006)

Table 3 – PERMITTED SIGN CHARACTERISTICS
BY SIGN DISTRICT

A = Allowed N = Not Allowed
(See Table 1 for permit requirements for signs)

	<u>Residential</u>	<u>Commercial/</u>	<u>Industrial</u>	<u>Institutional</u>
Changeable Copy	N	A (a)	A (a)	A (a)
Illumination, Internal	(b)	A	A	A
Illumination, External	(b)	A	A	A
Electronic variable message	N	A (d), (e)	A (d), (e)	A (d), (e)

- (a) Size of the Changeable Copy portion of a sign shall be limited to 25% of the entire sign, not including sign supports.
- (b) Illuminated signs are prohibited except for the following: Identification signs on residential dwelling units, signs identifying multiple dwelling developments and mobile home parks.
- (c) Signs within Commercial, Industrial and Institutional Areas require design review prior to the issuance of a sign permit. See 17.40.080 for design review guidelines. (Ord. 05OR006)
- (d) Size of the electronic variable message portion of a sign shall be limited to 25% of the entire sign, not including sign supports.
- (e) The provisions of section 17.40.170 ("Electronic Variable Message Signs") apply. (06OR011)

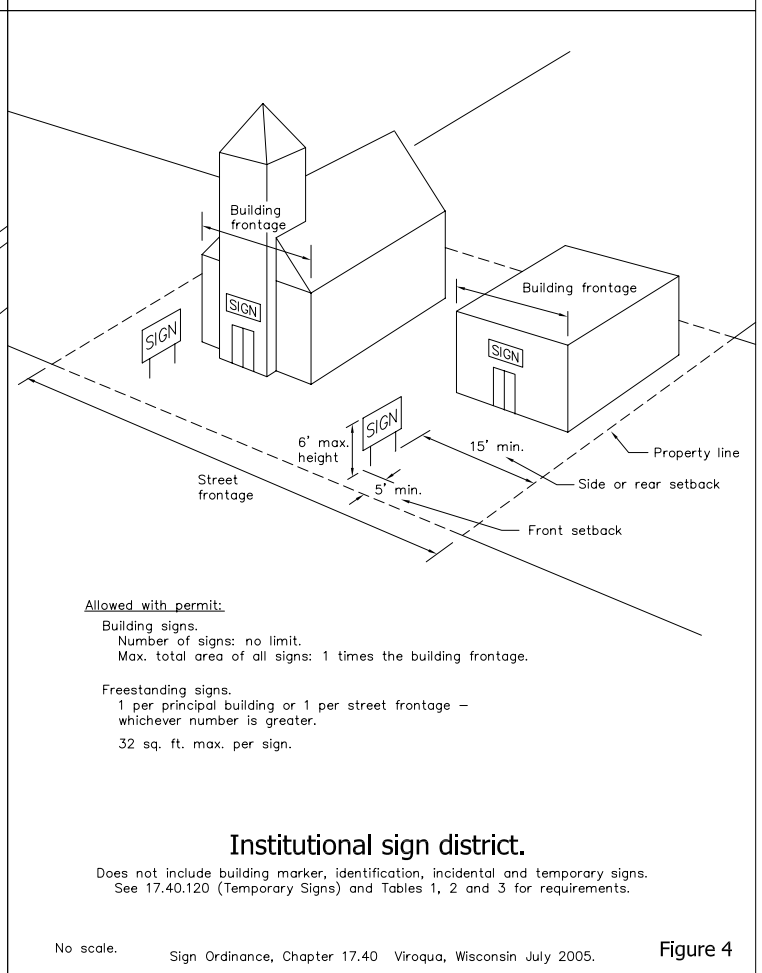
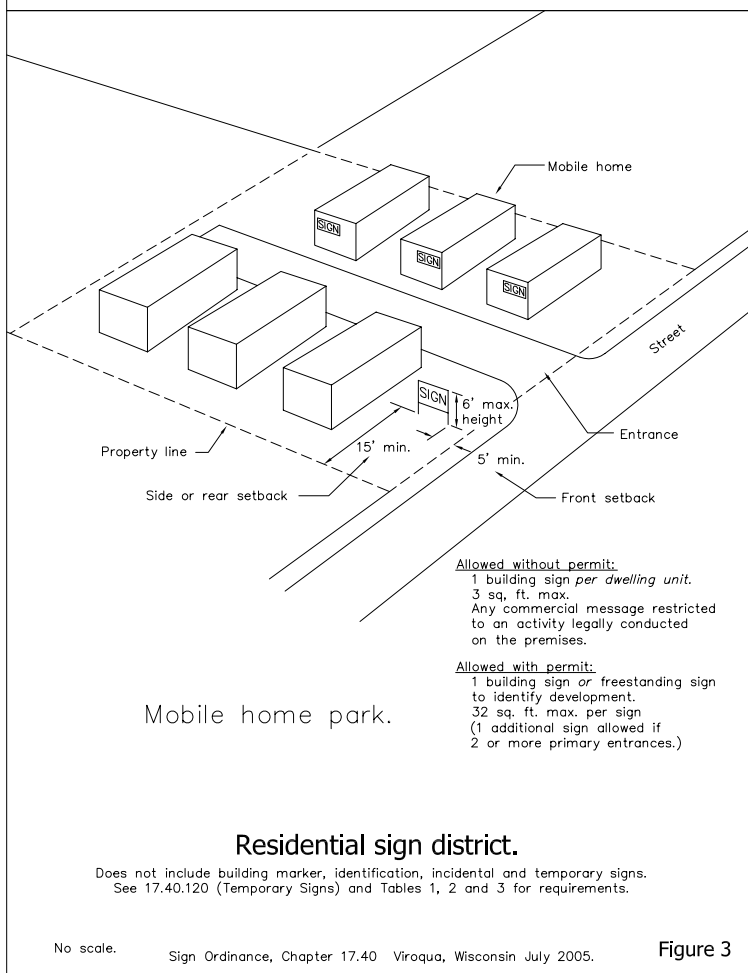
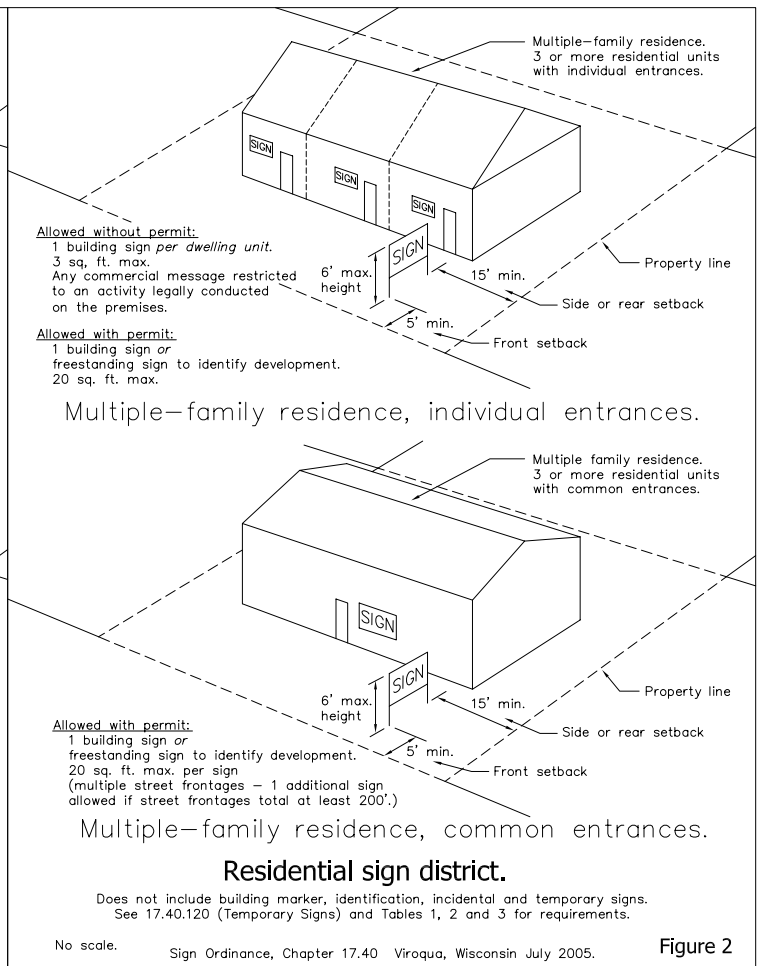
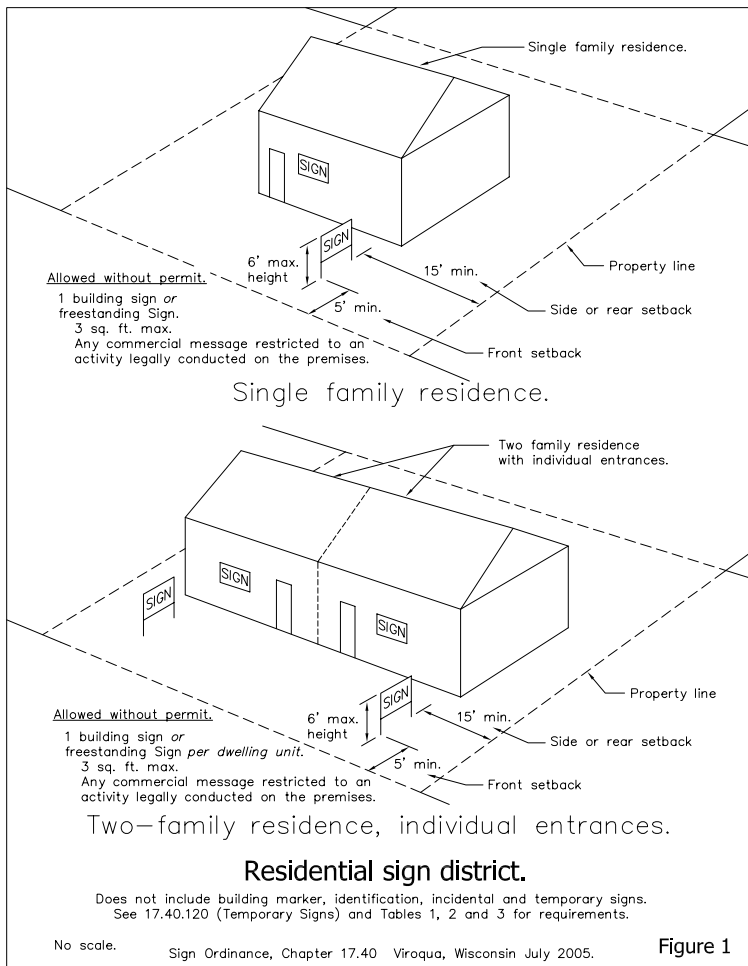

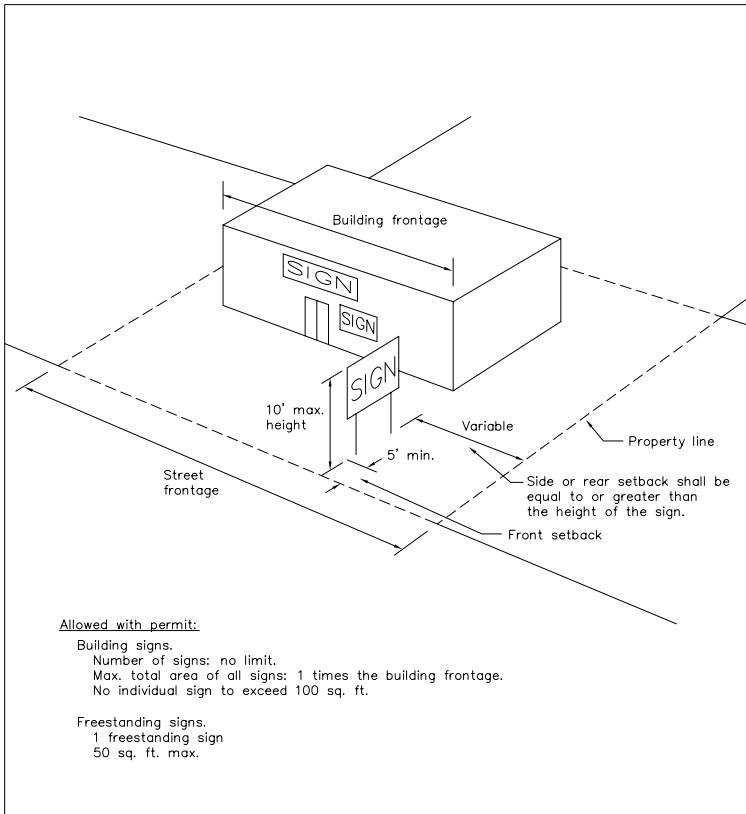

Allowed with permit:

Building signs.
 Number of signs: no limit.
 Max. total area of all signs: 1 times the building frontage.
 No individual sign to exceed 100 sq. ft.

Freestanding signs.
 1 freestanding sign
 50 sq. ft. max.

Industrial sign district.

Does not include building marker, identification, incidental and temporary signs.
 See 17.40.120 (Temporary Signs) and Tables 1, 2 and 3 for requirements.

Figure 5

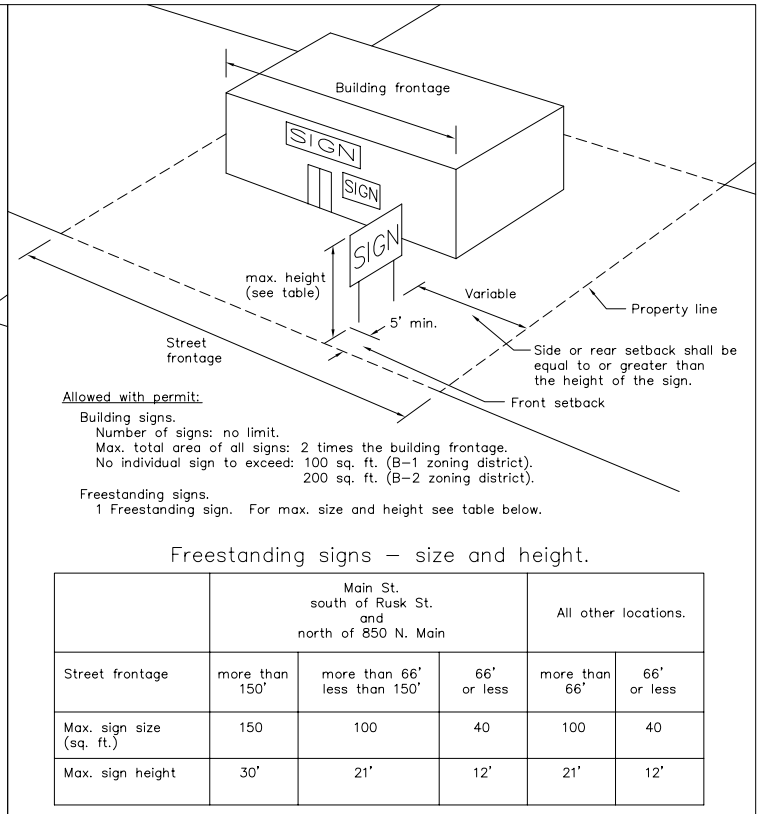

Freestanding signs – size and height.

	Main St. south of Rusk St. and north of 850 N. Main			All other locations.	
	more than 150'	more than 66' less than 150'	66' or less	more than 66'	66' or less
Street frontage					
Max. sign size (sq. ft.)	150	100	40	100	40
Max. sign height	30'	21'	12'	21'	12'

Commercial sign district.

Does not include building marker, identification, incidental and temporary signs.
 See 17.40.120 (Temporary Signs) and Tables 1, 2 and 3 for requirements.

Figure 6

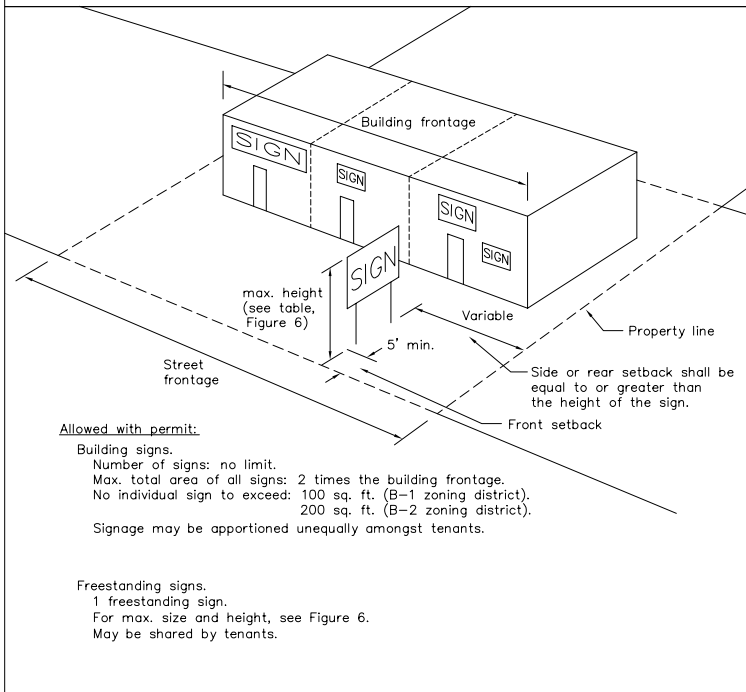

Multiple Occupancy.

Commercial sign district.

Does not include building marker, identification, incidental and temporary signs.
 See 17.40.120 (Temporary Signs) and Tables 1, 2 and 3 for requirements.

Figure 7

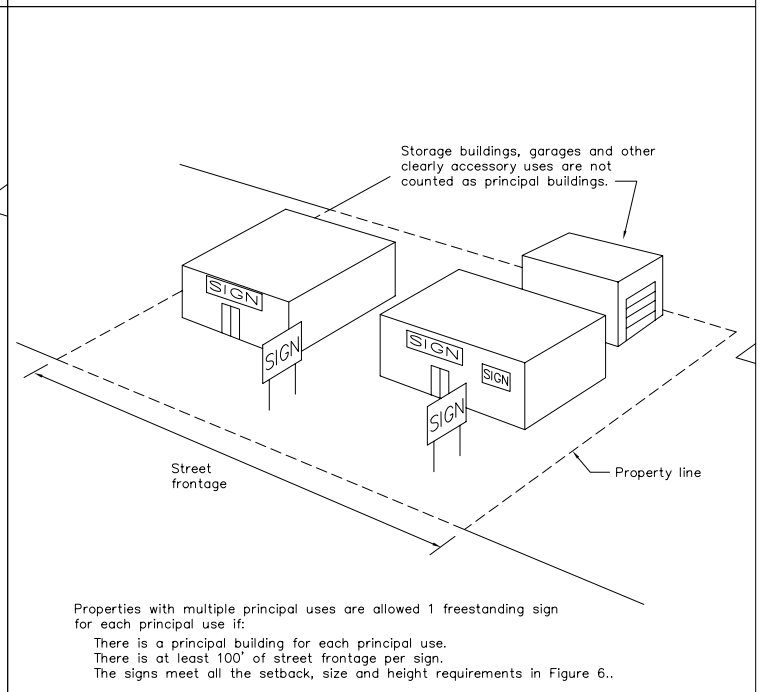

Multiple Principal Uses.

Commercial sign district.

Does not include building marker, identification, incidental and temporary signs.
 See 17.40.120 (Temporary Signs) and Tables 1, 2 and 3 for requirements.

Figure 8

Building not oriented toward the street.

When the primary building entrance(s) are oriented away from the street, that side of the building may be designated as the building frontage to determine the maximum allowable building signage.

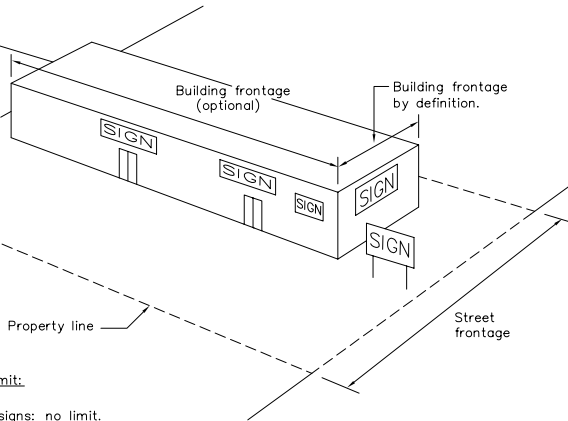

Allowed with permit:

Building signs.
 Number of signs: no limit.
 Max. total area of all signs: 2 times the building frontage.
 Up to 50% of the building signage may be transferred from the building frontage to other locations on the building.
 No individual sign to exceed: 100 sq. ft. (B-1 zoning district),
 200 sq. ft. (B-2 zoning district).

Freestanding signs.
 1 freestanding sign.
 For max. size and height, see Figure 6.

Non-highway oriented buildings.

Commercial sign district.

Does not include building marker, identification, incidental and temporary signs.
 See 17.40.120 (Temporary Signs) and Tables 1, 2 and 3 for requirements.

No scale. Sign Ordinance, Chapter 17.40 Viroqua, Wisconsin July 2005. **Figure 9**

Multiple street frontages.

Include all building frontages to determine allowable building signage.
 1 freestanding sign is allowed for each street frontage under some circumstances (see below).

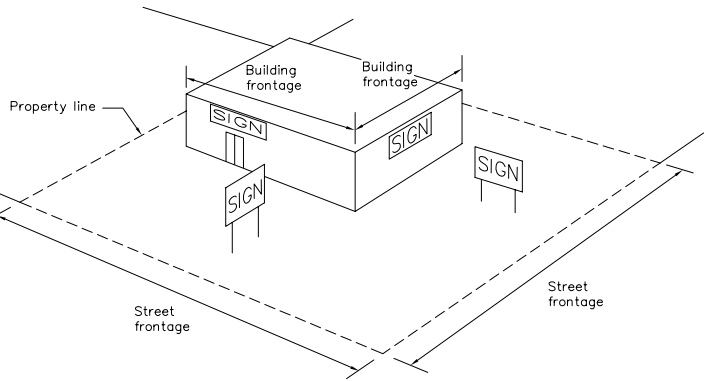

Allowed with permit:

Building signs.
 Number of signs: no limit.
 Max. total area of all signs: 2 times the building frontage.
 Up to 25% of building signage is transferrable from one building frontage to another, or to other locations on the building.
 No individual sign to exceed: 100 sq. ft. (B-1 zoning district),
 200 sq. ft. (B-2 zoning district).

Freestanding signs.
 1 per street frontage if street frontages total at least 200'.
 Sign must be oriented toward that street frontage.
 For max. size and height, see Figure 6.

Multiple Street Frontages.

Commercial sign district.

Does not include building marker, identification, incidental and temporary signs.
 See 17.40.120 (Temporary Signs) and Tables 1, 2 and 3 for requirements.

No scale. Sign Ordinance, Chapter 17.40 Viroqua, Wisconsin July 2005. **Figure 10**

Note: Change of copy to existing signs requires no permit, provided there is no structural alteration to sign.

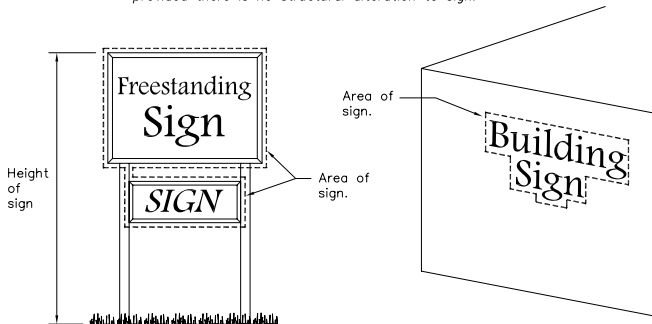

2 sides of a back to back sign.

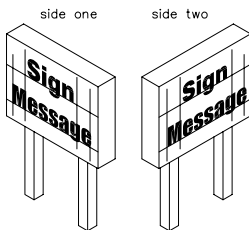

Two sides are identical.
 Include only one side when measuring area of sign.

2 sides of a back to back sign.

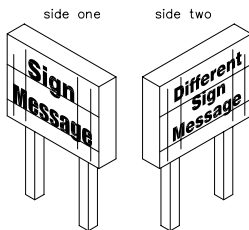

Two sides are not identical.
 Include both sides when measuring area of sign.

Computation of sign area and height. (all sign districts)

No scale. Sign Ordinance, Chapter 17.40 Viroqua, Wisconsin July 2005. **Figure 11**

Allowed with permit:

Building signs.
 Number of signs: no limit.
 Max. total area: 2 times the building frontage.
 Includes all permanent building signs: Wall, projecting, canopy, suspended, window.
 (Does not include Building marker, Identification, Incidental, and Temporary signs. Those signs require no permit but must comply with tables 1, 2 & 3.)
 No individual sign to exceed: 100 sq. ft. (B-1 district),
 200 sq. ft. (B-2 district).

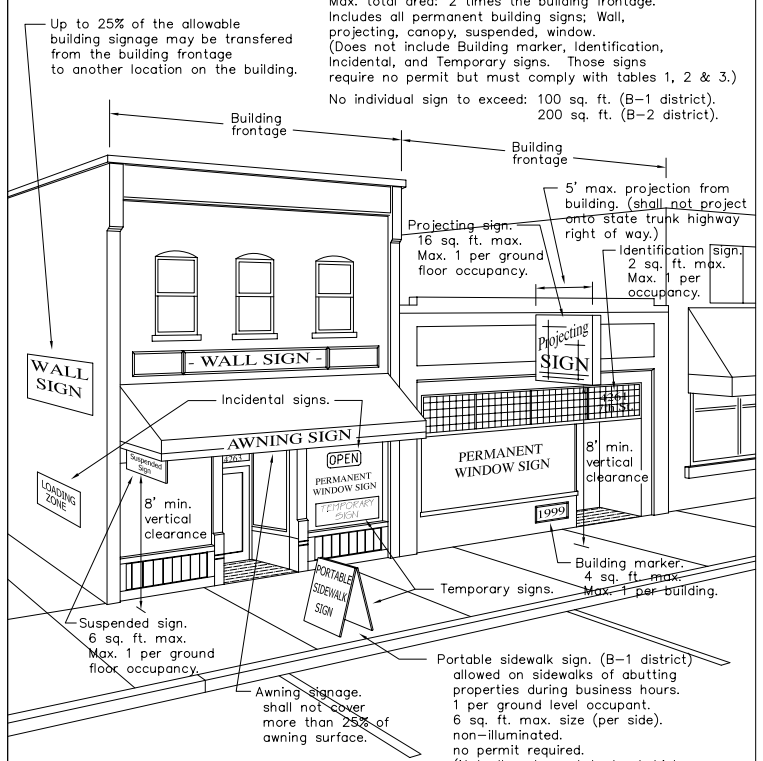

Commercial sign district.

For design review requirements in Main Street Program area see 17.40.080.

No scale. Sign Ordinance, Chapter 17.40 Viroqua, Wisconsin July 2005. **Figure 12**

Chapter 17.42

AIRPORT AREA ZONING

Sections:

17.42.010	Statutory Authorization
17.42.020	Definitions
17.42.030	Airport zones
17.42.040	Nonconforming uses
17.42.050	Airport Zone Height Limitations
17.42.060	Permits
17.42.070	Administration
17.42.080	Board of Appeals
17.42.090	Appeals and Review
17.42.100	Penalties

17.42.010 Statutory Authorization. This ordinance is adopted pursuant to Section 114.136, Wisconsin Statutes.

17.42.020 Definitions. As used in this ordinance, unless the context otherwise requires:

- a. "Airport" means the Viroqua Municipal Airport located in the City of Viroqua, Vernon County, Wisconsin.
- b. "Nonconforming use" means any structure which does not conform to the provisions of this ordinance or an amendment thereto, as of the effective date of this ordinance.
- c. "Person" means any individual, firm, partnership, corporation, company, association, joint stock association, or body politic, and includes any trustee, receiver, assigned, or other similar representative thereof.
- d. "Structure" means any object, including a mobile object, constructed, installed or located by a person.
- e. "Height" means the elevation above Mean Sea Level of the top of the structure, including any appurtenance installed thereon.
- f. "Permit" means written permission from the City of Viroqua on a form provided by the municipality stating that the proposed structure site either conforms to the Height Limitation Zoning Ordinance or has been granted a variance, pursuant to Section 17.42.060 of this ordinance.

17.42.030. Airport Zones. All zones established by this section are as shown on the map dated 11-07-07 entitled, "Height Limitation Zoning Map", Viroqua Municipal Airport, Vernon County, Wisconsin. (Ord 08OR010)

17.42.040. Nonconforming Uses. a. Not Retroactive. The regulations prescribed by this ordinance shall not be construed to require the removal, lowering or other change or alteration of any structure not conforming to the regulations as of the effective date of this ordinance, or otherwise interfere with the continuance of any non conforming use, except as otherwise provided by section 17.42.060. Nothing herein contained shall require any change in the construction, alteration or intended use of any structure, if the construction or alteration of such was begun prior to the effective date of this ordinance, and if such is diligently prosecuted.

b. Removal by Purchase. This section shall not interfere with the removal of nonconforming uses by purchase or the use of eminent domain.

17.42.050. Airport Zone Height Limitations. No objects of natural growth are permitted and no structure shall be constructed, altered or located to a height in excess of the elevation indicated on the map referred to in Section 17.42.030 of this Ordinance, except legal fences and farm crops which are cut at least once each year. Any such objects of natural growth and structure constructed, altered or located in violation of this ordinance shall be removed at the owner's expense. (Ord 08OR010)

17.42.060. Permits. a. Future Uses. No structure shall hereafter be constructed or located that exceeds the height indicated in any zone created by Section 17.42.030 of this ordinance until the owner or his/her agent shall have applied in writing and obtained a permit from the zoning administrator. Application for such permit shall indicate the purpose for which the permit is desired, with sufficient information to permit the zoning administrator to determine whether such structure would conform to the regulations herein prescribed. If such determination is in the affirmative, the permit shall be granted.

b. Existing Uses. Before any nonconforming structure may be replaced, altered, or rebuilt, a permit shall be applied for and secured in the manner prescribed in Section 17.42.060 (a) authorizing such change, replacement or repair. Such permit shall be granted if the structure will not become a greater hazard to air navigation than it was on the effective date of this ordinance, or than it was when the application for permit was made.

c. Exemptions. Permits are not required for structures which are less than thirty-five (35) feet in height above ground level at the structure site.

d. Posting. Said permit shall be posted in a prominent place on the premises prior to and during the period of construction, erection, installation or establishment.

e. Variances. Upon appeal in special cases the Board of Appeals may, after investigation and public hearing, grant a variance from the terms of this ordinance. Such variance shall not be contrary to the public interest or create a hazard to the safe, normal operation of aircraft.

17.42.070. Administration. It shall be the duty of the zoning administrator to administer and enforce the regulations prescribed herein. Applications for permits and variances shall be made on a form provided by the zoning administrator. Applications for permits shall be granted or denied within 30 days of the date of filing. Applications for variances shall include evidence of Federal Aviation Administration review of the proposed construction (FAA form 7460 -1 "Notice of Proposed Construction"). Appeals shall be transmitted by the zoning administrator to the Board of Appeals for hearing and decision. There shall be no charge for applications or permits.

17.42.080. Board of Appeals . The Board of Appeals created by section 17.12.030 shall hear and decide appeals under this ordinance.

17.42.090. Appeals and Review. a. Aggrieved Person. Any person aggrieved or affected by any decision or action of the zoning administrator made in the administration of this ordinance may appeal such decision or action to the Board of Appeals.

b. Procedure. Any appeal taken pursuant to this section shall be in conformity with the procedure established by the applicable Wisconsin statutes.

17.42.100 Penalties. Any person violating any of the provisions of this ordinance shall, upon conviction, forfeit not less than \$100.00 nor more than \$500.00 for such offense, together with the costs of prosecution and in default of payment of such forfeiture and costs of prosecution, shall be imprisoned in the County Jail until said forfeiture and costs are paid, but not to exceed 90 days for each violation. Each day that a violation continues shall constitute a separate offense.

Chapter 17.44

HISTORIC PRESERVATION

17.44.010 Purpose and Intent. It is hereby declared a matter of public policy that the protection, enhancement, perpetuation and use of improvements or sites of special character or special architectural or historic interest or value is a public necessity and is required in the interest of the health, prosperity, safety and welfare of the people. The purpose of this section is to:

A. Effect and accomplish the protection, enhancement, and perpetuation of such improvements, sites and districts which represent or reflect elements of the city's cultural, social, economic, political and architectural history.

B. Safeguard the city's historic and cultural heritage, as embodied and reflected in such historic structures, sites and districts.

C. Foster civic pride in the notable accomplishments of the past.

D. Stabilize and improve property values.

E. Protect and enhance the city's attractions to residents, tourists, and visitors, and serve as a support and stimulus to business and industry.

F. Improve and enhance the visual and aesthetic character of the city.

G. Educate the public regarding the need and desirability of a city historic preservation program and its enhancement of the quality of life.

17.44.020 Definitions. The definitions shall be as follows: A. Certificate of Appropriateness means the certificate issued by the commission approving alteration, rehabilitation, construction, reconstruction or demolition of a historic structure, historic site or any improvement in a historic district.

B. Commission means the historic preservation commission created under this section.

C. Historic district is an area designated by the Common Council on recommendation of the commission, that contains two or more historic improvements or sites, as well as those abutting improvement parcels which the commission determines should fall under the provisions of this section to assure that their appearance and development is harmonious with such historic structures or historic sites.

D. Historic site means any parcel of land of historic significance due to a substantial value in tracing the history or prehistory of man, or upon which a historic event has occurred, and which has been designated as a historic site under this section, or an improvement parcel, or part thereof, on which is situated a historic structure and any abutting improvement parcel, or part thereof, used as and constituting a part of the premises on which the historic structure is situated.

E. Historic structure means any improvement which has a special character or special historic interest or value as part of the development, heritage or cultural characteristics of the city, state or nation and which has been designated as a historic structure pursuant to the provisions of this chapter.

F. Improvement means any building, structure, place, work of art or other object constituting a physical betterment of real property, or any part of such betterment, including streets, alleys, sidewalks, curbs, lighting fixtures, signs and the like.

G. Improvement parcel is the unit of property which includes a physical betterment constituting an improvement and the land embracing the site thereof, and is treated as a single entity for the purpose of levying real estate taxes. Provided, however, that the term "improvement parcel" shall also include any unimproved area of land which is treated as a single entity for such tax purposes.

17.44.030 Historic Preservation Commission Composition: The Historic Preservation Commission shall consist of not less than seven (7) and not more than eleven (11) members. Attendance by four (4) or more members shall constitute a quorum. Of the membership, if available in the community, one shall be a registered architect; one shall be a historian; one shall be a licensed real estate broker; one shall be an alderperson; and at least three shall be citizen members. Each member shall have, to the highest extent practicable, a known interest in historic preservation. The Mayor shall appoint the commissioners subject to confirmation by the Common Council. The term for each member shall be three years. The office of a commissioner who is absent from three (3) meetings in any twelve (12) month period, without the prior excuse of the Chair, shall be vacant upon the Commission's decision. [Ord. 498, 1999; 06OR009]

17.44.040 Historic Structure, Historic Site and Historic District Designation Criteria.

A. For purposes of this ordinance, a historic structure, historic site, or historic district designation may be placed on any site, natural or improved, including any building, improvement or structure located thereon, or any area of particular historic, architectural, archaeological or cultural significance to the City such as historic structures, sites, or districts which:

1. Exemplify or reflect the broad cultural, political, economic or social history of the nation, state or community; or
2. Are identified with historic personages or with important events in national, state or local history; or

3. Embody the distinguishing characteristics of an architectural type or specimen inherently valuable for a study of a period, style, method of construction, or of indigenous materials or craftsmanship; or

4. Are representative of the notable work of a master builder, designer or architect who influenced his or her age; or

5. Have yielded, or may be likely to yield, information important to prehistory or history.

B. The commission may adopt specific operating guidelines for historic structure, historic site and historic district designation providing such are in conformance with the provisions of this ordinance.

17.44.050 Powers and Duties

A. Designation . The commission shall have the power subject to section 17.44.060, to recommend designation of historic structures, sites, and districts within the City limits. Such designations shall be made based on section 17.44.040. Historic structures, sites, and districts as recommended shall require approval by the Common Council. Once designated and approved, such historic structures, sites and districts shall be subject to all the provisions of this ordinance.

B. Regulation of Construction, Reconstruction, alteration and Demolition.

1. No owner or person in charge of a historic structure, historic site or structure within a historic district shall reconstruct, alter or demolish all or any part of the exterior of such property or construct any improvement upon such designated property or properties or cause or permit any such work to be performed upon such property or demolish such property unless a Certificate of Appropriateness has been granted by the Historic Preservation Commission. Unless such certificate has been granted by the commission, the building inspector shall not issue a permit for any such work.

2. Upon filing of any application for a Certificate of appropriateness with the commission, the commission shall approve the application unless:

a. In the case of a designated historic structure or historic site, the proposed work would detrimentally change, destroy or adversely affect any exterior architectural feature of the improvement or site upon which said work is to be done;

b. In the case of the construction of a new improvement upon a historic site, or within a historic district, the exterior of such improvement would adversely affect or not harmonize with the external appearance of other neighboring improvements on such site or within the district;

c. In the case of any property located in a historic district, the proposed construction, reconstruction, exterior alteration or demolition does not conform to the purpose and intent of this chapter and to the objectives and design criteria of the historic preservation plan for said district;

d. The building or structure is of such architectural or historical significance that its demolition would be detrimental to the public interest and contrary to the general welfare of the people of the city and state;

e. The building or structure is of such old and unusual or uncommon design, texture, and/or material that it could not be reproduced without great difficulty and/or expense;

f. In the case of a request for the demolition of a deteriorated building or structure, any hardship or difficulty claimed by the owner is self-created or is the result of any failure to maintain the property in good repair.

Provided, however, that the commission shall approve the application if, in case of a request for a demolition permit, the denial of the permit would result in the loss of all reasonable and beneficial use of or return from the property.

3. In addition, in determining whether to issue a Certificate of Appropriateness, the commission shall consider and may give decisive weight to any or all of the following standards:

a. A property shall be used for its historic purpose or be placed in a new use that requires minimal change to the defining characteristics of the building and its site and environment.

b. The historic character of a property shall be retained and preserved. The removal of historic materials or alteration of features and spaces that characterize a property shall be avoided.

c. Each property shall be recognized as a physical record of its time, place, and use. Changes that create a false sense of historical development, such as adding conjectural features or architectural elements from other buildings, shall not be undertaken.

d. Most properties change over time; those changes that have acquired historic significance in their own right shall be retained and preserved.

e. Distinctive features, finishes, and construction techniques or examples of craftsmanship that characterize a property shall be preserved.

f. Deteriorated historic features shall be repaired rather than replaced. Where the severity of deterioration requires replacement of a distinctive feature, the new feature shall match the old in design, color, texture, and other visual qualities and, where possible, materials. Replacement of missing features shall be substantiated by documentary, physical, or pictorial evidence.

g. Chemical or physical treatments, such as sandblasting, that cause damage to historic materials shall not be used. The surface cleaning of structures, if appropriate, shall be undertaken using the gentlest means possible.

h. Significant archaeological resources affected by a project shall be protected and preserved. If such resources must be disturbed, mitigation measures shall be undertaken.

i. New additions, exterior alterations, or related new construction shall not destroy historic materials that characterize the property. The new work shall be differentiated from the old and shall be compatible with the massing, size, scale and architectural features to protect the historic integrity of the property and its environment.

j. New additions and adjacent or related new construction shall be undertaken in such a manner that if removed in the future, the essential form and integrity of the historic property and its environment would be unimpaired.

4. If the commission determines that the application for a certificate of Appropriateness and the proposed changes are consistent with the character and features of the property or district, and with the above guidelines, it shall issue the Certificate of Appropriateness. Upon the issuance of such certificate, the building permit shall then be issued by the building inspector. The commission shall make this decision within forty-five (45) days of the filing of the application.

5. Agencies of the city and all public utility and transportation companies, undertaking projects affecting historic structures, historic sites or historic districts, shall be required to obtain a Certificate of Appropriateness prior to initiating any changes in the character of street paving, sidewalks, utility installations, lighting, walls, fences, structures, and buildings on property, easements, or streets owned or franchised by the city.

6. The issuance of a Certificate of Appropriateness shall not relieve the applicant from obtaining other permits and approvals required by the city. A building permit or other municipal permit shall be invalid if it is obtained without the presentation of the Certificate of Appropriateness required for the proposed work. Insofar as they are applicable to a historic structure, historic site, or improvement in a historic district designated under this section, any provision of the plumbing code, electrical code, or building or housing of the city shall apply, unless waived by the appropriate state or city officials. The commission may support or propose such waivers before the appropriate state or city appeals body.

7. Compliance, with Certificates of Appropriateness shall be started within twelve (12) months after the issuance of the certificate, and the work shall conform to the provisions of the certificate. The city may inspect the work during and after construction in order to assure compliance. Failure to comply with a Certificate of Appropriateness or failure to obtain a Certificate of Appropriateness shall be a violation of this section. In addition to other penalties and remedies, the city shall issue a stop work order, and all work shall cease on the designated property. No additional work shall be undertaken as long as such stop work order shall continue in effect.

8. Ordinary maintenance and repairs may be undertaken without a Certificate of Appropriateness provided that the work involves repairs to existing features of a historic structure or site or the replacement of elements of a structure with piece identical in appearance and provided that the work does not change the exterior appearance of the structure or site and does not require the issuance of a building permit.

C. Appeals. Should the commission fail to issue a Certificate of Appropriateness due to the failure of the proposal to conform to the guidelines, the applicant may appeal such decision to the Common Council within thirty (30) days. In addition, if the commission fails to issue a Certificate of Appropriateness, the commission shall, with the cooperation of the applicant, work with the applicant in an attempt to obtain a Certificate of Appropriateness within the guidelines of this ordinance.

D. Recognition of Historic Structures, Sites and Districts. At such time as a historic structure, site or district has been properly designated, the commission may cause to be prepared and erected on such property at city expense, a suitable plaque declaring that such property is a historic structure, site or district. Such plaque shall be so placed as to be easily visible to passing pedestrians. The plaque shall state the accepted name of the historic property, the date of its construction of significance, and other information deemed proper by the commission.

E. Other Duties. In addition to those duties already specified in this section, the commission shall:

1. Work for the continuing education of the citizens about the historical heritage of this city and the historic properties designated under the provision of this section.

2. Cooperate with the State of Wisconsin historic preservation officer and the State Historic Preservation Review Board in attempting to include such properties hereunder designated as landmarks or landmark sites, or historic districts in the National Register of Historic Places and the State Register of Historic Places.

3. As it deems advisable, receive and solicit funds for the purpose of historic preservation in the city. Such funds shall be placed in a special city account for such purpose.

17.44.060 Procedures.

A. Designation of Historic Structures and Historic Sites

1. The commission may, after notice and public hearing, designate historic structures and historic sites, subject to Council approval, or rescind such designation or recommendation, subject to Council approval, after application of the criteria in section 17.44.040. At least ten (10) days prior to such hearing, the commission shall notify the owners of record, as listed in the office of the city assessor, who are owners of property in whole or in part situated within two hundred (200) feet of the boundaries of the property affected. These owners shall have the right to confer with the commission prior to final action by the commission on the designation. Notice of such hearing shall also be published as Class 1 Notice, under the Wisconsin Statutes. The commission shall also notify the following: Department of Public Works, Redevelopment authority, Parks Division, Fire and Police Departments, Health Department, building Inspection Division, and Plan commission. Each such department may respond to the commission with its comments on the proposed designation or rescission.

2. The commission shall then conduct such public hearing and, in addition to the notified persons, may hear expert witnesses and shall have the power to subpoena such witnesses and records as it deems necessary. The commission may conduct an independent investigation into the proposed designation or rescission. Within ten (10) days after the close of the public hearing, the commission may designate the property as either a historic structure or historic site, or rescind the designation, subject to Council approval. After the designation or rescission has been made and approved by the Council, notification shall be sent to the property owner or owners. Notification shall also be given to the City Clerk, building Inspection division, Plan Commission, and the City Assessor. The commission shall cause the designation or rescission, upon Council approval, to be recorded, at city expense, in the County Register of Deeds office.

B. Designation of Historic Districts. 1. For preservation purposes, the Historic Preservation Commission shall select geographically defined areas within the city to be designated as Historic Districts and shall, with the assistance of the City Planning Department, prepare a historic preservation plan in ordinance form for each area. A Historic District may be designated for any geographic area of particular historic, architectural or cultural significance to the city which:

a. Exemplifies or reflects the broad cultural, political, economic or social history of the nation, state or community; or

b. Is identified with historic personages or with important events in national, state or local history; or

c. Embodies the distinguishing characteristics of architectural types or specimens inherently valuable for the study of a period or periods, styles, methods or construction, or of indigenous materials or craftsmanship; or

d. Is representative of the notable works of master builders, designers, or architects who influenced their age.

e. Has yielded, or may be likely to yield, information important to history or prehistory.

Each historic preservation plan prepared for or by the Historic Preservation Commission shall include a cultural and architectural analysis supporting the historic significance of the area, the specific guidelines for development and a statement of preservation objectives.

2. Guideline criteria to be considered in the development of Historic District plans are as follows:

a. Regulation of construction, reconstruction, alteration and demolition shall conform to the criteria and standards in Section 17.44.050 B.I., 2., and 3.

b. All new structures shall be constructed to a height visually compatible with the building and environment with which they are visually related.

c. The gross volume of any new structure shall be visually compatible with the buildings and environment with which it is visually related.

d. In the street elevation of a building, the proportion between the width and height in the facade should be visually compatible with the building and environment with which it is visually related.

e. The proportions and relationships between doors and windows in the street facade should be visually compatible with the buildings and environment with which it is visually related.

f. The rhythm of solids to voids, created by openings in the facade, should be visually compatible with the buildings and environment with which it is visually related.

g. The existing rhythm created by existing building masses and spaces between them should be preserved.

h. The materials used in the final facade should be visually compatible with the buildings and environment with which it is visually related.

i. The texture inherent in the facade should be visually compatible with the buildings and environment with which it is visually related.

j. Colors and patterns used on the facade (especially trim) should be visually compatible with the buildings and environment with which it is visually related.

k. The design of the roof should be visually compatible with the buildings and environment with which it is visually related.

l. The landscape plan should be sensitive to the individual building, its occupants and their needs. Further, the landscape treatment should be visually compatible with the buildings and environment with which it is visually related.

m. The street facade should blend with other buildings via directional expression. When adjacent buildings have a dominant horizontal or vertical expression, this expression should be carried over and reflected.

n. Architectural elements should be incorporated as necessary to relate the new with the old and to preserve and enhance the inherent characteristics of the area.

3. Review and Adoption Procedure. a. Historic Preservation Commission. The Historic Preservation Commission shall hold a public hearing when considering the plan for a Historic District. Notice of the time, place and purpose of such hearing shall be given by publication as a Class 1 Notice under the Wisconsin Statutes in the official city paper. Notice of the time, place and purpose of the public hearing shall also be sent by the City Clerk to the Alderman of the aldermanic District or districts in which the Historic District is located, and the owners of record, as listed in the office of the City Assessor, who are owners of the property within the proposed Historic District or are situated in whole or in part within two hundred (200) feet of the boundaries of the proposed Historic District. Said notice is to be sent at least ten (10) days prior to the date of the public hearing. Following the public hearing, the Historic Preservation Commission shall vote to recommend, reject or withhold action on the plan. This recommendation shall be forwarded to the City Plan Commission and the Common Council.

b. The City Plan Commission. The Plan Commission shall review the Historic District plan and make a recommendation to the Common council. The Plan Commission shall make its recommendation on the Historic District plan within thirty (30) days.

c. The Common Council. The Common Council, upon receipt of the recommendations from the Historic Preservation Commission and Plan Commission, shall hold a public hearing, notice to be given as noted in subparagraph a. above and shall following the public hearing either designate or reject the Historic District. Designation of the Historic District shall constitute adoption of the plan in ordinance form prepared for that district and direct the implementation of said plan.

17.44.070 Interim Control. No building permit shall be issued by the building inspector for alteration, construction, demolition, or removal of a nominated historic structure, historic site, or any property or structure within a nominated historic district from the date of the meeting of the Historic Preservation Commission at which a nomination form is first presented until the final disposition of the nomination by the Historic Preservation Commission or the City Council unless such alteration, removal or demolition is authorized by formal resolution of the City Council as necessary for public health, welfare or safety. In no event shall the delay be for more than one hundred eight (180) days.

17.44.080 Conformance with Regulations. A. Every person in charge of a historic structure, historic site or improvement in a Historic District shall maintain same or cause or permit it to be maintained in a condition consistent with the provisions of this ordinance. The City Council may appoint the building inspector or any other individual or group of individuals to enforce this ordinance. The duties of the inspection officer shall include periodic inspection at intervals provided by the City Council of designated historic structures, historic sites and historic districts. These inspections may include physical entry upon the property and improvement, with permission of the owner, to insure that interior alterations or maintenance will not jeopardize the exterior appearance or structural stability of the improvement. If an owner refuses permission for the enforcement officer to enter for purposes of inspection, the inspection officer may obtain a warrant of entry pursuant to s. 66.122, Wis. Stats., and take any other reasonable measures to further enforcement of this ordinance.

B. Every person in charge of an improvement on a historic site or in a Historic District shall keep in good repair all of the exterior portions of such improvement and all interior portions thereof which, if not so maintained, may cause or tend to cause the exterior portions of such improvement to fall into a state of disrepair, including but not limited to:

1. The deterioration of exterior walls or other vertical supports;
2. The deterioration of roofs or other horizontal members;
3. The deterioration of external chimneys.
4. the deterioration or crumbling of exterior plasters or mortar;
5. The ineffective waterproofing of exterior walls, roofs, and foundations, including broken windows or doors;
6. The peeling of paint, rotting, holes, and other forms of decay;
7. The deterioration of surrounding environment, e.g., fences, gates, sidewalks, steps, signs, accessory structures, and landscaping;
8. The deterioration of any features so as to create or permit the creation of any hazardous or unsafe condition or conditions.

9. All interior portions thereof which may cause the exterior to deteriorate or become damaged or otherwise to fall into a state of disrepair.

The purpose of this section is to prevent the demolition of a building or structure by neglecting it and permitting damage to it by weather or vandalism.

C. Insofar as they are applicable to a historic structure, historic site or improvement in a historic district, designated under this section, any provision of the Plumbing Code, the Minimum Housing and Property Maintenance Code, building Code, Heating, Ventilating and Air Conditioning Code, and Outdoor Signs and Outdoor Advertising Structures regulations of the General Ordinances may be varied or waived, on application, by the appropriate board having such jurisdiction over such chapter or, in the absence of such board, by the building inspector, provided such variance or waiver does not endanger public health or safety.

17.44.090 Penalties for Violations. Any person or persons violating any provision of this section shall be fined two hundred dollars (\$200) for each separate violation. Each and every day during which a violation continues shall be deemed to be a separate offense. Notice of violations shall be issued by the building inspector. If the violations remain uncorrected after the time specified in the notice, the city may, at its election, impose fines and/or have the violations corrected at city expense and have a lien placed against the property equal to the cost of the repairs, plus applicable fines and administrative costs.

17.44.100 Emergency Conditions. In any case where the building inspector determines that there are emergency conditions dangerous to life, health or property affecting a historic structure, site or a property in a historic district, the building inspector may order the remedying of these conditions without the approval of the commission. The building inspector shall promptly notify the commission of the action being taken. When the emergency conditions do not require demolition, the building inspector shall make every effort to carry out the intent of this ordinance and to use the design guidelines of the commission when remedying the emergency conditions.

17.44.110 Separability. If any provision of this chapter or the application thereof to any person or circumstances is held invalid, the remainder of this chapter and the application of such provisions to other persons or circumstances shall not be affected thereby. (Ord 458, 1995)

TABLES
OF ORDINANCES ADOPTED

Ordinance

Number:

- 1 Construction and interpretation of ordinances (Repealed by 278)
- 2 Prohibits immoral acts, gaming devices (Repealed by 282)
- 3 Prohibits gambling (9.04)
- 4 Prohibits cruelty to animals (6.12)
- 5 Licenses certain amusements and hacks to fairgrounds (Repealed by 282)
- 6 Prohibits disturbing the peace (9.16)
- 7 Designates jail term for nonpayment of fines (Repealed by 281)
- 8 Prohibits playing ball in the streets, bicycles on the sidewalk, and discharging firearms within the city (9.24)
- 9 Owner or occupant to keep streets and sidewalks clean and free of snow and ice (12.12)
- 10 Prohibits injuring public trees (12.20)
- 11 Prohibits obstructing streets; restricts speed of animals on streets (12.12)
- 12 Curfew for minors (Repealed by 282)
- 13 Accepts grant; levies tax for library (Special)
- 14 Prohibits acts offensive to the public health; establishes board of health (Repealed by 282)
- 15 Sidewalk construction (Special)
- 16 Franchise (Special)
- 17 Franchise (Special)
- 18 Franchise (Special)
- 19 Franchise (Special)
- 20 Franchise (Special)
- 21 Sets election times, terms of office (2.36)
- 22 Railroad right-of-way (Special)
- 23 Franchise (Special)
- 24 License to move buildings (15.32)
- 25 Property acquisition (Special)
- 26 Establishes cemetery trust (3.16)
- 27 Licenses billiard tables (Repealed by 282)
- 28 Prohibits large animals in the city (9.08)
- 29 Licenses transient merchants (Repealed by 282)
- 30 Regulates motor vehicles (Repealed by 282)
- 31 Designates labor of prisoners (Repealed by 282)
- 32 Prohibits littering (Repealed by 282)
- 33 Establishes board of park commissioners (2.20)
- 34 Prohibits obstructing view in restaurants (5.40)
- 35 Designates numbering of buildings (12.24)
- 36 Establishes city plan commission (Repealed by 282)
- 37 Franchise (Special)

38 Bond (Special)
39 Franchise (Special)
40 Bond (Special)
41 Parking near fire hydrants; right-of-way for fire vehicles (Repealed by 282)
42 Bond; special election (Special)
43 Regulates water use; sets rates for water, light and heat (13.04)
44 Establishes volunteer fire department (2.24)
45 Establishes fire limits; regulates building and construction (Repealed by 283)
46 Picture machines (15.28)
47 Building inspection (15.20)
48 Regulates keeping and selling of explosives (8.08)
49 Street maintenance by property owners (8.20, 12.12)
50 Public garages (15.24)
51 Fire escapes (15.20)
52 Refuse burning (8.20)
53 Discharge and sale of fireworks (8.12)
54 Franchise (Special)
55 Bond (Special)
56 Bond (Special)
57 Franchise (Special)
58 Public intoxication (Repealed by 261 and 281)
59 Motor vehicles (Repealed by 281)
60 Removal of street signs and barricades (10.12)
61 Sale of milk (Repealed by 282)
62 (Lost or not issued)
63 (Lost or not issued)
64 (Lost or not issued) (Repealed by 129)
65 (Lost or not issued)
66 (Lost or not issued)
67 (Lost or not issued)
68 (Lost or not issued)
69 (Lost or not issued)
70 Parking (Not sent)
71 Dogs (Not sent)
72 Vehicles (Not sent)
73 Franchise (Special)
74 Board of public works (Special)
75 Liquor (Repealed by 213)
76 Garbage (Repealed by 85)
77 Transient merchant licensing (Repealed by 282)
78 Amend §4 of Ord. 5, amusements licensing (Repealed by 282)
79 Soda water sales (Repealed by 213)
80 Malt beverages and wine (Repealed by 213)
81 Amends Ord. 80, malt beverages and wine (Repealed by 213)
82 Regulates air exhibitions; licenses pilots (5.08)
83 Dairies (Repealed by 133)
84 Adds §6A to Ord. 43, water meter reading (13.04)

- 85 Garbage collection (8.16)
- 86 Disposal and collection of rubbish (8.24)
- 87 Licenses public dancing (5.36)
- 88 Drawing on city funds (3.04)
- 89 Regulates sale of malt beverages (Repealed by 213)
- 90 Regulates mud traps for sewer system (Repealed by 283)
- 91 Regulates sale of liquor (Repealed by 213)
- 92 Taverns and liquor stores ((Repealed by 213)
- 93 Salaries (Special)
- 94 Traffic (Repealed by 248)
- 95 Licenses campgrounds; regulates trailers (Repealed by 282)
- 96 Licenses transient merchants (Repealed by 320)
- 97 Repeals parts of Ord. 93 (Not sent)
- 98 License fees for soda water (Not sent)
- 99 Salary of assessor (Special)
- 100 Dogs (Not sent)
- 101 Junk Shops (Repealed by 167)
- 102 All-night parking (Repealed by 246)
- 103 Designates arterial highways (Repealed by 282)
- 104 Bicycles (Repealed by 282)
- 105 Buildings (Repealed by 161)
- 106 Dogs (Not sent)
- 107 Blackout during war (expired)
- 108 Victory tax (Special)
- 109 Dogs (Not sent)
- 110 Residence district establishment and regulations (Repealed by 283)
- 111 Building code (Repealed by 161)
- 112 Franchise (Special)
- 113 Creates building committee (Not sent)
- 114 Regulates pool halls, taverns, and similar establishments (Not sent)
- 115 Pool halls (9.32)
- 116 Salaries (Special)
- 117 Poll hours during elections (2.36)
- 118 Sidewalk standards (12.04)
- 119 Water and sewer connections (13.20)
- 120 Licenses vehicles for hire (5.48)
- 121 Selection of assessor (Not sent)
- 122 Assessor's salary (Repealed by 126)
- 123 Salary of police (Not sent)
- 124 All-night parking (Repealed by 282)
- 125 Parking time on Main Street (Repealed by 282)
- 126 Authorizes police to accept bail (Repealed by 282)
- 127 Sets assessor's salary; repeals Ord. 121 (Repealed by 282)
- 128 Establishes sewer service charge (13.16)
- 129 Parking (Repealed by 282)
- 130 Establishes board of review; repeals Ord. 64 (2.24)
- 131 Parking (Repealed by 282)
- 132 Designates city treasurer's organization of tax rolls (3.08)

- 133 Wards (Repealed by 181)
- 134 Licenses milk vendors (8.04)
- 135 Disposition of sewer service revenue (13.16)
- 136 Amends §6 of Ord. 133, milk sales (8.04)
- 137 Amends §1 of Ord. 134, sewer service revenue (13.16)
- 138 Establishes permits for soliciting ((Repealed by 320)
- 139 Establishes water service charges (Not sent)
- 140 Financing sewer service (Not sent)
- 141 Composition of police and fire commission (Repealed by 153)
- 142 Repeals parts of Ord. 140, police and fire commission (Repealer)
- 143 Traffic regulation (Repealed by 282)
- 144 Creates office of city engineer (Not sent)
- 145 Establishes city plan commission (2.28)
- 146 Fluoridation (Repealed by 149)
- 147 Abolishes constable, transfers power to chief of police (Special)
- 148 Amends §6(1) of Ord. 119, vehicles for hire (5.48)
- 149 Prohibits all-night parking in municipal lots (10.28)
- 150 Repeals Ord. 145 (Repealer)
- 151 Designates arterials for through traffic (Repealed by 282)
- 152 Traffic (Repealed by 282)
- 153 Curfew (Repealed by 251)
- 154 Repeals Ord. 140 (Repealer)
- 155 Creates parking meter zones (Repealed by 296)
- 156 Amends §3(a) of Ord. 127, sewer rates (13.16)
- 157 Licenses slaughterhouses (8.32)
- 158 Abolishes treasurer and assessor, establishes treasurer-assessor (2.08)
- 159 Salaries (Special)
- 160 Dogs (Repealed by 216)

Ordinance

Number:

- 161 Zoning (Title 17)
- 162 Regulates buildings and construction (15.04, 15.08, 15.12, 15.16, 15.20)
- 163 Salaries (Special)
- 164 Dogs (Repealed by 216)
- 165 Amends §2 of Ord. 60, zoning (Not sent)
- 166 Tax collection, repealed by Council action on February 26, 1976 (Not sent)
- 167 Repeals and replaces §13 and §14 of Ord. 154 (Repealed by 296)
- 168 Licenses junkyards; repeals Ord. 100 (5.24)
- 169 Amends §11 of Ord. 160 (Not sent)
- 170 Amends §5 of Ord. 160, zoning (17.20)
- 171 Amends §2 of Ord. 154, parking meter zones (Repealed by 296)
- 172 Amends §3(d) to Ord. 161; amends §§2(f), 2(g), 3(b), 4(a), 4(b), 12(b), 15(c), 18(b) and 29(b) of Ord. 161; repeals §15(d) of Ord. 161, buildings and construction (15.04, 15.08, 15.12, 15.16, 15.20)
- 173 Livestock running at large (Repealed by 295)
- 174 Adds permitted uses to §7 of Ord. 160, zoning (17.28)
- 175 Amends §11 of Ord. 160, zoning (Not sent)
- 176 Clerk's salary (Special)
- 177 Establishes civil defense organization (Not codified)
- 178 Adds subsection (c) to §26 of Ord. 161, buildings and construction (15.20)
- 179 Amends §11 of Ord. 160, zoning (Not sent)
- 180 Adds permitted uses to §7(2) of Ord. 160, zoning (17.28)
- 181 Amends Ord. 147 and §6(1) of 119, insurance for taxicabs (5.48)
- 182 Traffic (Repealed by 282)
- 183 Amends §11 of Ord. 160 (Not sent)
- 184 Salaries (Special)
- 185 Adds subsection (15) to §3 of Ord. 181, traffic (Repealed by 282)
- 186 Salaries (Special)
- 187 Liquor licenses (Not sent)
- 188 Amends §11 of Ord. 160 (Not sent)
- 189 Mobile homes (Not codified)
- 190 Annexation (Special)
- 191 Flammable liquids (Repealed by 195)
- 192 Curb and gutter assessments, street grades, water and sewer main extensions and service connections (3.12)
- 193 Special assessment interest rate (Not sent)
- 194 Amends §3 of Ord. 114, minors in pool halls (9.32)
- 195 Amends §§3(2), 3(5), 3(7), and 3(9), and repeals 3(8) of Ord. 181 (Repealed by 282)
- 196 Repeals Ord. 190 (Repealer)
- 197 Creates justice of the peace (Repealed by 282)
- 198 Discharge of wastes into sewer (Repealed by 314)

Ordinance

Number:

- 199 Amends §11 of Ord. 160, zoning (Not sent)
- 200 Snow and ice removal; repeals §2 of Ord. 9 (12.16)
- 201 Snow and ice removal (12.16)
- 202 Amends §11 of Ord. 160, zoning (Not sent)
- 203 Amends §11 of Ord. 160, zoning (Not sent)
- 204 Adds §3(b) to Ord. 181; renumbers §3 of Ord. 181, traffic (Repealed by 282)
- 205 Amends §11 of Ord. 160, zoning (Not sent)
- 206 Refuse disposal (8.20)
- 207 Water service outside city (13.08)
- 208 City authority to construct curbs, gutters and sidewalks (3.04)
- 209 Creates special police auxiliary (2.12)
- 210 Amends §11 of Ord. 160, zoning (Not sent)
- 211 Cable television (5.16)
- 212 Amends §11 of Ord. 160, zoning (Not sent)
- 213 Salaries (Special)
- 214 Amends §7 of Ord. 160, zoning; closing times for liquor establishments; repeals
Ords. 75, 79, 80, 81, 88, 90, and 91 (5.20, 17.28)
- 215 Bond (Special)
- 216 Excavation of public ways (12.08)
- 217 Repeals Ords. 159 and 163, dogs (Repealed by 295)
- 218 Salaries (Special)
- 219 Amends §11 of Ord. 160, zoning (Not sent)
- 220 Creates office of city forester (8.36)
- 221 Salaries (Special)
- 222 Cable television (Repealed by 226)
- 223 Annexation (Special)
- 224 Keeping of junk automobiles (8.28)
- 225 Wards (1.08)
- 226 Amends §11 of Ord. 160, zoning (17.16)
- 227 Amends §§2 and 3 of Ord. 210, cable television franchise (Special)
- 228 Amends §1 of Ord. 192, special assessment (3.12)
- 229 Adopts joint civil defense plan (2.40)
- 230 Amends §2(2) of Ord. 160, zoning (17.16)
- 231 Amends §8 of Ord. 216, dog pound (Repealed by 295)
- 232 Adds §3(a)(16), 3(a)(17), 3(c) and 3(d) to Ord. 181, traffic (Repealed by 282)
- 233 Salaries (Special)
- 234 Underground utilities (12.08)
- 235 Mobile homes (5.28)
- 236 Amends §§4 and 9 of Ord. 216, dogs (Repealed by 295)
- 237 Number not used
- 238 Salaries (Special)

Ordinance

Number:

- 238 Noxious weeds (8.32)
- 239 Amends §3(14) of Ord. 160, zoning (17.08)
- 240 Salaries (Special)
- 241 Amends Ord. 26, cemetery trust fund (3.16)
- 242 Parking (Repealed by 282)
- 243 Open liquor containers (5.20, 9.12)
- 244 Establishes office of city clerk and deputy city clerk (2.04)
- 245 Salaries (Special)
- 246 Parking (Not codified)
- 247 Drinking establishments (5.20)
- 248 Traffic (10.04, 10.08, 10.12, 10.16, 10.20, 10.24, 10.28, 10.36)
- 248A Adds §2.1 to Ord. 248, traffic (10.08)
- 249 Adds subsection (20) to §8 of Ord. 160, zoning (17.32)
- 250 Fire hydrants (13.12)
- 251 Curfew (9.28)
- 252 Adds §3.1 to Ord. 248, traffic (10.20)
- 253 Boisterous language (9.16)
- 254 Discharge of weapons (9.36)
- 255 Salaries (2.32)
- 256 Subdivisions (Title 16)
- 257 Amends §§4(1) and 7(2) of Ord. 248, traffic (Repealed by 296)
- 258 Adds §18 to Ord. 160, zoning (Not codified)
- 259 Amends §3(3) of Ord. 248, traffic (10.24)
- 260 Adds §18 to Ord. 160, zoning (17.48)
- 261 Repeals Ord. 58 (Repealer)
- 262 Repeals and replaces §18(D) of Ord. 260, zoning (17.48)
- 263 License fees (5.04)
- 264 Sale of liquor (5.20)
- 265 Annexation (Special)
- 266 Activities on school grounds (9.20)
- 267 Annexation (Special)
- 268 (Never completed)
- 269 Annexation (Special)
- 270 Outdoor markets (5.32)
- 271 Amends §4(1)(g) of Ord. 248, parking (Repealed by 296)
- 272 Annexation (Special)
- 273 Rezone (Special)
- 274 Repeals and replaces §3 of Ord. 248, traffic (10.20)
- 275 Amends subsection 91) of §4 of Ord. 248, parking (10.28)
- 276 Amends Ord. 248, parking (10.28)
- 277 Amends §1 of Ord. 243, illegal possession of alcoholic beverages (9.12)

Ordinance

Number:

- 278 General provisions; repeals Ord. 1 (1.04)
- 279 General penalty (1.12)
- 280 Adds subsection (6) to Ord. 224, wards (1.08)
- 281 Amends Ord. 3 by repealing phrases in §§1, 2 and 3, gambling; amends §3 of Ord. 24 by deleting phrase, moving of buildings; amends §11 of Ord. 86 by deleting phrase, public dancing; amends §16(1) of Ord. 119, vehicles for hire; repeals and replaces Ord. 60, traffic; repeals Ord. 7, 31 and 58 (5.36, 5.48, 6.12, 9.04, 10.12, 15.32)

- 282 Amends §1 of Ord. 33, board of park commissioners; amends §§5 and 6 of Ord. 82, aircraft; amends subsections B and C of §1 of Ord. 137, soliciting; repeals and replaces §5 of Ord. 157, treasurer-assessor; repeals and replaces §3 of Ord. 167, junkyards; repeals and replaces §9 of Ord. 248, traffic; repeals and replaces §2 of Ord. 24, moving buildings; repeals §§1, 2 and 3 of Ord. 6, §§2 and 3 of Ord. 8, and §4 of Ord. 49; repeals Ords. 2, 5, 14, 27, 29, 30, 32, 36, 41, 51, 61, 77, 78,94, 102, 103, 123, 124, 125, 126, 128, 130, 142, 150, 181,184, 194, 196, 203, 231 and 242 (2.08, 2.20, 5.08, 5.24, 5.44, 10.04, 15.32)

- 283 Repeals and replaces §§6 and 14 of Ord. 43, water; repeals and replaces §§3(a), 4(a) and 6 of Ord. 161, buildings and construction; repeals §4 of Ord. 127; repeals Ords. 45, 89 and 109 (13.04, 15.12, 15.16, 15.20)

- 284 Repeals and replaces §1 of Ord. 148, parking (Repealed by 289)
- 285 Annexation (Special)
- 286 Abolishes municipal court (Not codified)
- 287 Establishes method of selection for city attorney
- 288 Releases Broadcaster-censor from damage liability for police/fire radio base station (2.12)
- 289 Repeals and replaces Ord. 148, all-night parking in municipal lots (10.28)
- 290 Rezone (Special)
- 291 Requires operator's license for premises operated under Class B license (5.20)
- 292 Prohibits minors on Class B licensed premises (9.12)
- 293 Annexation (Special)
- 294 Prohibits pornographic material or performances (9.40)
- 295 Animals regulations; repeals Ords. 172, 216, 230, 235 (6.04)
- 296 Establishes parking meter zones; repeals and replaces §4(1) of Ord. 248; repeals Ords. 154, 166, 170, 257, 271 (10.28)
- 297 Adds paragraph to §4(1) of Ord. 248, parking (10.28)
- 298 Adopts code of Viroqua Municipal Ordinances (1.01)
- 299 Airport traffic (10.40)
- 300 Repeals §5.20.050 (Repealer)
- 301 Adds §5.20.015, intoxicating liquors (5.20)

Ordinance

Number:

- 302 Adds Ch. 10.38, squealing tires (10.38)
- 303 Sewer service and cost recovery charges (13.28)
- 304 Annexation (Special)
- 305 Adds §12.12.120, obstructing streets and sidewalks (12.12)
- 306 Adds §10.16.015, speed limits (10.16)
- 307 Adds subsection D to §10.28.060, parking (Repealed by 326)
- 308 Adds §§9.12.102, 9.12.103, 9.12.104, 9.12.105, possession of alcoholic beverages by minors (9.12)
- 309 Adds Ch. 9.38, shoplifting (9.38)
- 310 Repeals and replaces subsection C of §8.36.050, Dutch elm disease; repeals §8.36.070 (8.36)
- 311 Adds Ch. 15.18, one-family and two-family dwelling building code (15.18)
- 312 Adds Ch. 9.10 (theft & destruction of property)
- 313 Adds. Ch. 9.06 (resisting an officer)
- 314 Adds. Ch. 13.24 (sewage waste disposal) (Repeals Ch. 13.24)
- 315 Adds to 9.06.010 (obstructing officers)
- 316 Adds 10.28.060(E) (parking) (repealed by 335)
- 317 Authorizes use of school bus warning lights (10.12)
- 318 Speed limit on portion of North Main St. (repealed by 327)
- 319 Repeals & recreates Ord. 306 (speed limit on West Broadway) (repealed by 327)
- 320 Repeals & recreates Ch. 5.44 (transient merchants)
- 321 Annexation (Special)
- 322 Repeals & recreates 5.28.020(C) (mobile homes)
- 323 Repeals & recreates 12.16.030 (deposit of snow on streets)
- 324 Repeals & recreates 13.24.060(C) (sewage waste disposal)
- 325 Adds 6.04.105 (cooperative agreements for impounding dogs)
- 326 Repeals & recreates 10.28.040 (B) (parking)
- 327 Repeals Ords. 318 & 319 (Repealer)
- 328 Class A. liquor license fee (5.04)
- 329 Repeals & recreates 208.040 (city assessor)
- 330 Repeals & recreates 8.16.040 (garbage collection) & 8.24.010 (dumping)
- 331 Trespassing (9.26)
- 331 Possession of marijuana (9.14)
- 332 Repeals & recreates 8.08.010, 8.08.040 (explosive storage)
- 334 Amusement device arcade licensing (5.14)
- 335 Repeals & recreates Ord. 316 (parking) (10.28)
- 336 Possession of firearms on premises licensed to sell fermented malt beverages (5.20)
- 337 Repeals & recreates 10.32.020(C) (parking) (repealed by 344)
- 338 Designates "no parking" zone (10.28)
- 339 Repeals & recreates 10.28.070 (parking) (10.28)
- 340 Adds Ch. 2.42 (records maintenance & access) (2.42)

Ordinance

Number:

- 341 Adds. Ch. 17.38 (zoning) (17.38)
- 342 Alcoholic beverage license denial (5.20)
- 343 Amends 10.32.020 (parking meters) (repealed by 344)
- 344 Adds 10.28.015 (parking) (repeals Ch. 32) (10.28)
- 345 Annexation (Special)
- 346 Repeals & recreates 1.08.020 – 1.08.070 (wards)
- 347 Adds 10.28.040 (E) (parking)
- 348 Regular police department (2.11)
- 349 Amends Ch. 212 (Special police department) (2.12)
- 350 Amends Ch. 216 (Volunteer fire department) (2.16)
- 351 Adds 10.24.010(N) (through highway) (10.24)
- 352 Adds 10.28.040(f) (repealed by 354)
- 353 Annexation (special)
- 354 Repeals & recreates 10.28.040(f) (parking) (10.28)
- 355 Annexation (special)
- 356 Annexation (special)
- 357 Annexation (special)
- 358 Adds 10.24.010(P) (through highways) & 1028.040(G) (parking) (10.24, 10.28)
- 359 Adds subsections (H) & (I) to 10.28.040 (parking)
- 360 Annexation (special)
- 361 Repeals & recreates 10.28.110 – 10.28.140 (parking)
- 362 Adds subs. (J) to §10.28.040 (parking)
- 363 Adds subs. (P) & (Q) to §10.24.010 (stop signs)
- 364 Repeals & recreates 5.28.020C (temporary mobile homes)
- 365 Repeals & recreates 10.16.020 (speed limit decrease)
- 366 Adds subs. (K) to §10.28.040 (parking)
- 367 Adds subs. (R) to §10.24.010 (stop signs)
- 368 Adds Sections 12.04.060 (sidewalks)
- 369 Repeals & recreates Sections 10.04.010A & 16.08.010 (subdivisions)
- 370 Adds subs. (S) & (T) to §10.24.010 (stop signs)
- 371 Adds subs (L) to §10.28.040 (parking)
- 372 Adds Ch. 3.14 (gas bill assessments)
- 373 Adds subs. (U) to §10.24.010 (stop signs)
- 374 Repeals & recreates Section 5.32.0101 (Farmers Mkt.)
- 375 Annexation (Gardner)
- 376 Adds Ch. 12.26 & Repeals & recreates §16.12.110C (street grades)
- 377 Revises 10.28.040H (parking Vernon Memorial)
- 378 Revises 5.04 (Business licenses)
- 379 Revises 5.02.080 (Operator’s licenses)
- 380 Revises 17.24.010 (off street parking, multiple family district)
- 381 Revises 8.20.030 (private disposal at landfill)

Ordinance

Number:

- 382 Revises 5.04.020 (cigarette licenses)
- 383 Adds 10.28.040M (parking between Chicago and Bekkedal Court)
- 384 Revises 5.32.010 (Farmers Markets)
- 385 Creates Ch. 2.30 (Health officer)
- 386 Revises 6.04.040 – 6.04.070 (Dogs)
- 387 Adds 10.28.04N (parking of semis)
- 388 Adds 10.28.040) (parking on N. Rock)
- 389 Adds 10.28.040P (parking on S. Main)
- 390 Repeals 6.04.080 (rabies, other animals)
- 391 Revises 8.20.010 (transport of garbage)
- 392 Creates 9.42 (harassment)
- 393 Creates 9.10.030 (worthless checks)
- 394 Revises 10.28.070 (night parking restrictions)
- 395 David Lake property annexation (not codified)
- 396 Creates 10.28.040L (parking on S. Rusk & Hickory)
- 397 Landfill Assessment (repealed by No. 401)
- 398 Revised Zoning Code (creates 17.104, 17.08, 17.12, & 17.16)
- 399 Creates 13.30 (Cross Connections Ordinance)
- 400 Creates 10.26 (one way traffic on Court Street)
- 401 Revised refuse and garbage regulations (Creates Ch. 8.18)
- 402 Revises 10.24.020 to give Chief of Police authority over parking, stopping
- 403 Amends alcohol beverages regulation (Ch. 5.20) & Taxi Ord. (Ch. 5.48); repeals 5.08; 5.12; 5.36; 5.40
- 404 Prohibits fluoride (not codified)
- 405 Establishes 1 alderman for each ward (not codified)
- 406 Establishes citation procedure
- 407 Private well provisions
- 408 Amends Ord. regarding fees for garbage removal
- 409 Amends zoning Ord. regarding duplexes on common lot line
- 410 Hours for Class "A" licenses
- 411 Chain of command in fire department
- 412 Re-zones Sherry property as Industrial Park (not codified)
- 413 Revises bond amounts in citation procedure
- 414 Compensation for alderman, mayor
- 415 Penalty to remove snow
- 416 Police and fire commission
- 417 Airport area zoning
- 418 Penalty for disorderly conduct
- 419 Outdoor "farmers" market
- 420 Qualifications for firefighters
- 421 Sewer and water extension costs

Ordinance

Number:

- 422 Regulation of bicycles, skateboards, etc.
- 423 Number of buildings on a lot
- 424 Airport commission
- 425 Annexing the Viroqua Airport (not codified)
- 426 City pays taxes on default of treasurer
- 427 Airport regulation
- 428 Weed ordinance
- 429 Alcohol beverage operator's license
- 430 Aldermanic districts/wards
- 431 Annexation of Alan Bennett parcel (not codified)
- 432 Annexation of City parcel obtained from Alan Bennett (not codified)
- 433 Alcohol beverages (underage persons)
- 434 Subdivision, public dedications
- 435 Airport user fees
- 436 Fireworks
- 437 Auctions and other street obstructions
- 438 Open burning
- 439 Prohibiting smoking in City Hall
- 440 Sewer use and user charges
- 441 Annex Zogg, Trappe & Larson parcel (not codified)
- 442 Annex Schroeder parcel (not codified)
- 443 CATV
- 444 Revises sewer rates
- 445 Annex Wolenc parcel (not codified)
- 446 Annex KMK parcel (not codified)
- 447 Annex Roth parcel (not codified)
- 448 Annex Country Club parcel (not codified)
- 449 Amend zoning re: lots w/o access
- 450 Creating Viroqua Municipal Golf Utility
- 451 Annex Spaeth property (not codified)
- 452 Annex Tally property (not codified)
- 453 Annex Municipal Golf Utility and City Parcels (not codified)
- 454 Motor vehicle traffic at pool
- 455 Viroqua Sesquicentennial Commission
- 456 Conditional uses, Multiple family district
- 457 Subdivision; street
- 458 Historic preservation
- 459 Annex Alan Bennett property along Hwy. 14 (not codified)
- 460 Permit fees, buildings, signs
- 461 Dogs in parks
- 462 Annex Jim Olson Ford parcel (not codified)

Ordinance

Number:

- 463 City charge as sewer customer
- 464 Annex Deters property (not codified)
- 465 Annex County parcel on Hwy. B (not codified)
- 466 Sewer rates (not codified)
- 467 (Ordinance not adopted)
- 468 Park commission, members
- 469 Eckhardt Enchantment, hours
- 470 Open burning, days permitted
- 471 Retail "Class A" liquor
- 472 Annex K. Johnson property (not codified)
- 473 Assessing delinquent garbage, refuse, etc., against real estate
- 474 Secondary meters
- 475 Airport
- 476 Amending zoning code (fences, pools, etc.)
- 477 Conditional uses (Bethel Home)
- 478 Prohibiting certain animals
- 479 Rezone Strang property
- 480 Eckhardt Enchantment hours
- 481 Animals in cemeteries/parks
- 482 Property maintenance
- 483 Viroqua Municipal Airport – structure height
- 484 Permit fees – swimming pools, fences
- 485 Annex Vernon County property
- 486 Exempt decorative ponds from regulation
- 487 Provide stop signs at certain intersections with Chicago Avenue
- 488 Annexation of Charles & Ruth Lee property (not codified)
- 489 Drug paraphernalia use by persons under 17 years of age
- 490 Prohibits fraud on hotel or restaurant keeper
- 491 Provides for stop signs at certain intersections with Chicago Ave
- 492 Trees and shrubs on public grounds
- 493 Rezoning Peterson Motors property (not codified)
- 494 Rezoning new Wal-Mart property (not codified)
- 495 Changes the tenure of office of alderpersons
- 496 Rezoning LanBar property (not codified)
- 497 Provides for a 15 mph speed limit at the park on Lewison Lane
- 498 Increases number of Commissioners - Historic Preservation Commission
- 499 Emergency Government
- 500 Imposes a moratorium on off-premises signs
- 501 Confidentiality of information obtained by the assessor
- 502 Annexation of Cleary Equipment property (not codified)
- 503 Annexation of Richard Volden property (not codified)

Ordinance

Number:

- 504 Annexation of Cleary Equipment property - additional (not codified)
- 505 Annexation of Chicago Avenue Extension (not codified)
- 506 Cross Connection Control
- 507 Corrects legal description of Clary land previously annexed (not codified)
- 508 Annexation of Thomas A. and Joy C. Hanson property (not codified)
- 509 Annexation of Kathryn Johnson property (not codified)
- 510 Increases number of Airport Commissioners from five to seven
- 511 Requires parks in new mobile home developments
- 512 Requires plans for subdivision plats to be submitted to Public Works and Parks and Recreation committees
- 513 Closing times for parks and other facilities
- 514 Prohibits bows and arrows, javelins, et. in public parks
- 515 Sidewalk replacement procedures
- 516 Extending moratorium on off-premise signs (revised in Ord 518)
- 517 Trees and Shrubs
- 518 Imposes a moratorium on certain signs
- 519 Adds offices of 2nd assistant chief and 3rd captain to the chain of command of the Fire Department
- 520 Truancy and School Dropout
- 521 Providing notice to adjacent property owners is not required for routine maintenance of trees
- 522 Increases the penalty for parking violation
- 523 Room tax for tourism promotion and development
- 524 Wards (not codified - ordinance not adopted)
- 525 Pertaining to conditional use procedures under the zoning code
- 526 Create Comprehensive Planning Commission
- 527 Establish 9 aldermanic districts coinciding with the 9 City Wds
- 528 Sign moratorium (expired 10-01-2002)
- 529 Amend the Airport Commission Code to provide that an "aircraft" rather than airplane is subject to user fees
- 530 Dividing the City into Wards
- 531 Pertaining to the room tax for tourism promotion and development
- 532 To allow manufacturing and assembling as a condition use in the commercial district
- 533 Revising the room tax for tourism promotion and development
- 534 Regulating dogs, cats, and other animals
- 535 Providing for cat licenses and taxes
- 536 Establishing an advisory committee to evaluate the City's need for an outdoor aquatic facility
- 537 Authorizing veterinarians and humane societies to issue dog and cat licenses

Ordinance

Number:

- 538 Creating the position, duties, and responsibilities of the Office of City Administrator
- 539 Revising sewer charges
- 540 Revising ordinance establishing an advisory committee to evaluate the City's need for an outdoor aquatic facility
- 541 Imposing a moratorium on certain signs
- 542 Changing the zoning code
- 543 Amending the room tax ordinance
- 544 Pertaining to dumpsters
- 545 Regarding sewer connection charges
- 546 Regarding temporary water meters
- 547 Regarding compression brakes
- 548 Regarding dangerous dogs
- 549 Implementing sewer rates effective 08-01-03
- 550 Rezoning re: Library (not codified)
- 551 Volunteer firefighters' fund account
- 552 Imposing a moratorium on certain signs
- 553 Subdivision development and Developer Agreement
- 554 Regarding stop signs [Rusk and Hickory; Rusk and Oak]
- 555 Imposing fees for certain Fire Department responses

(Note: In 2004 the City changed its ordinance numbering. The last ordinance under the numeric system is #555. Ordinances subsequent to #555 have an alpha -numeric system beginning with the calendar year designation (e.g. "04" meaning year 2004) the letters "OR" meaning "ordinance" and a three digit number (e.g., "001" is the first ordinance adopted in the year in question)

- 04OR001 Open Burning regulated
- 04OR002 Increasing "Class A" intoxicating liquor licenses from 2 to 4
- 04OR003 Rezoning part of Engels property (not codified)
- 04OR004 Imposing a moratorium on certain signs
- 04OR005 Penalty for late payment of room tax
- 04OR006 Prohibiting future Outdoor Heating Devices
- 04OR007 Establishing tourism committee re room tax
- 04OR008 Annexing Vernon County jail site (not codified)
- 05OR001 Creating Municipal Court
- 05OR002 Sign permit fees and penalties
- 05OR003 Annexing Starr Trust, Hanson Trust, Lancaster property (not codified)
- 05OR004 Repeals obsolete code provisions: (repeals Chapters 3.08 "Tax Roll", 8.04 "Dairy Products", and 15.28 "Motion Picture Machinery")
- 05OR005 Amends zoning Code uses in Agricultural District, Single and Two-Family District, Multiple Family District, Central Business District, Commercial District, and Industrial District.
- 05OR006 Signs (revision of Chapter 17.40)

Ordinance

Number:

05OR007 Worthless Checks (revises 9.10.030)
05OR008 Pet grooming conditional use in R-2 district (revises 17.08.010 R-2)
05OR009 Combining offices of Clerk and Treasurer (revises Chapters 2.04 and 2.08)
05OR010 Municipal Court juvenile jurisdiction (revises 2.06.040)
05OR011 Permit for demolition (creates 15.04.045)
06OR001 Board of Park Commissioners (revises Chapter 2.20)
06OR002 Trees and Shrubs (revises Chapter 8.36)
06OR003 Rezones Forest Hills Addition from A-1 Agricultural Transition District to R-1 Single and Two-Family Residence District (not codified)
06OR004 Warrant and process fees in Municipal Court (revises 2.06.060)
06OR005 Annexation of Veldhuizen property (not codified)
06OR006 Prohibiting Drug Paraphernalia (revises Chapter 9.41)
06OR007 Penalizing False Police Alarms (revises 9.16.020)
06OR008 Reserve Police Officers (revises Chapter 2.12)
06OR009 Historic Preservation Commission composition (revises 17.44.030)
06OR010 Moratorium on issuing permits for electronic variable message signs (not codified; expires November 1, 2006)
06OR011 Electronic Variable Message Signs (amends Chapter 17.40)
06OR012 Rezones land in Industrial Park (not codified)
06OR013 Veterans Memorial Commission (creates Chapter 2.44)
06OR014 Operators license and provisional licenses (amends 5.20.050)
07OR001 Ordinance adopting Comprehensive Plan (not codified)
07OR002 Ordinance regarding leachate received at WWTP
07OR003 Ordinance Annexing County Erlandson Building area (not codified)
07OR004 Ordinance regarding utility service in areas before annexation
07OR005 Cross Connection Control
07OR006 Private Fire Hydrants
07OR007 Removing snow from sidewalks
07OR008 Toys for Tots Commission
08OR001 Adopts State One- and Two-Family Dwelling Code
08OR002 Revises Building, Plumbing, HVAC, Electrical, and related codes (Title 15)
08OR003 Redefines "Solid Fuel Fired Heating Devices", Chapter 8.11
08OR004 Revises parts of Chapter 10.28 regarding parking restrictions
08OR005 Revises Chapter 12.12 regarding obstructing public ways
08OR006 Revises parts of Chapter 15.20 of the Fire Code
08OR007 Chapter 15.19 Building Permit and Inspection Fees
08OR008 Section 2.38.090 Aircraft user fee by Airport Commission Resolution
08OR009 Penalty for Battery
08OR010 Airport Height Limitation Zoning Sections 17.42.030 and 17.42.050
08OR011 Heavy Traffic Routes
08OR012 Private Wells
08OR013 Water system cross connection control
08OR014 Building numbers
08OR015 Solid waste and recycling surcharge

Ordinance
Number:

09OR001 Solid waste and recycling surcharge delinquent if not paid in 20 days
09OR002 Rezoning land on CTH "B" - Grace Church (not codified)
09OR003 Frequency of fire inspections (amends section 15.20.140)
09OR004 Unlawful discrimination in housing (created Chapter 9.02)
09OR005 Solid waste and recycling surcharge (Chapter 8.18)

I0OR001 Matters referred to Plan Commission (section 2.28.040)
10OR002 Administrator's appointment of personnel (section 2.09.040 (C) 3.)
10OR003 Commercial use in Industrial Park (section 17.08.020 B-4 2.)
10OR004 Sewer User Charges (section 13.20.050 D)
10OR005 Annex Ekern property (not codified)
10OR006 Regulating smoking (Chapter 8.14)
10OR007 Rezoning land (Lot 3, CSM V 10 p 130, Railroad Avenue) (not codified)
10OR008 Wellhead Protection (creates Chapter 13.34)
10OR009 Revises 2.16.030 and 2.16.040 re fire department
I0OR010 Cost recovery for privately-paid public improvements (section 3.12.075)
I0OR011 Private water and septic systems (section 17.04.080 C)

I1OR001 Revises parking regulations: section 10.28.070 and 10.28.080
11OR002 Public Work without Bidding: creates Chapter 12.28
11OR003 Revises City Wards: Chapter 1.08
11OR004 Authorizes 10 Retail "Class A" Intoxicating Liquor Licenses
11OR005 Revises Chapter 8.18: Regulation of Solid Waste

12OR001 Creates Ch 9.46 Prohibiting Certain Electronic Messages
12OR002 Revises 8.14.010 (ak) defining "enclosed place" where smoking prohibited
12OR003 Creates 17.08.020 B-2 3. i. to make "day care and nursery school"
conditional uses in the Commercial District
12OR004 Revises 2.32 compensation of mayor and alderpersons effective 2014
12OR005 Revises 13.20 Sewer Use and User Charges
12OR006 Revises 2.06.030 municipal court: term of office and filing officer

13OR001 Revises Chapter 13.30 Cross Connection Control
13OR002 Revises Section 15.04.080 Demolition Permits
13OR003 Revises Chapter 12.12 Obstructing Streets, Sidewalks, Public Ways
13OR004 Revises Chapter 8.11 Solid Fuel Burning Devices
13OR005 Revises Chapter 12.28 Public Works without Bidding

Ordinance
Number:

- 14OR001 Revision of Chapter 13.34 Wellhead Protection
- 14OR002 Revision of Section 13.20.030 C. 2. Mandatory Hookup to City sewer
- 14OR003 Revision of Section 12.12.010 Boulevard Flower Gardens in 2014
- 14OR004 Rezoning Country Acres Addition re Bethel Home (not codified)
- 14OR005 Creates Chapter 9.48 False Statement or Record
- 14OR006 Creates Chapter 5.21 Reserve "Class B" License Grant
- 14OR007 Creates Chapter 1.06 Code of Ethics
- 14OR008 Adoption of Municipal Code (not codified)

- 15OR001 Revision of Chapter 12.12 Obstructing Streets etc
- 15OR002 Annexation of 2 County 40s to City (not codified)
- 15OR003 Rezoning Land North of Arena Drive and West of 902-910 Railroad Avenue (not codified)

- 16OR001 Creates Chapter 10.46 Neighborhood Electric Vehicles
- 16OR002 Revision of Chapter 2.16.030 Organization and Membership of the Fire Department
- 16OR003 Revision of Chapter 13.20 Sewer Use and User Charges
- 16OR004 Revision of Chapter 2.06 Municipal Court
- 16OR005 Creates Chapter 17.09 Planned Unit Development
- 16OR006 Rezoning Land North of State Hwy 56 and East of County Trunk Highway "B" (not codified)
- 16OR007 Revision of Chapter 17.40.080 Design Review Board
- 16OR008 Revision of Chapter 13.20.050 Sewer Use and User Charges
- 16OR009 Rezoning Land Lots 1&2 of Certified Survey Map 586 as recorded with Vernon County Register of Deeds in Volume 8 CSM 186, Document No. 428906 (not codified)

- 17OR001 Creates Chapter 2.48 Tourism Commission
- 17OR002 Revision of Chapter 3.20 Imposing a Room Tax for Tourism Promotion and Development
- 17OR003 Revision of Chapter 17.08 R-2 Multiple Family Residence District
- 17OR004 Revision of Chapter 6.04 Regulating Dogs, Cats and Other Animals
- 17OR005 Revision of Chapter 8.32 Noxious Weeds and Regulation of Length of Turf Grasses
- 17OR006 Revision of Chapter 17.08.020 B-4 Industrial Park District
- 17OR007 Revision of Chapter 12.12 Obstructing Streets, Sidewalks and Other Public Ways
- 17OR008 Creates Chapter 10.48 Races on City Streets
- 17OR009 Revision of Chapter 17.08.020 B-4 Industrial Park District

- 18OR001 Creates Chapter 8.22 Composting

Ordinance
Number:

19OR001 Revision of Section 6.04.140 Certain Animals Prohibited
19OR002 Revision of Section 13.020.070(A) Sewer Service Charge Payment and Penalty
19OR003 Revision of Section 13.04.130(A) Fee for Turning Off or Turning On City Water
19OR004 Revision of Sections 17.08.020(3) B-1 Central Business District, 17.08.020(3)
Commercial District and 17.08.020(3) Industrial District
19OR005 Revision of Section 5.20 Intoxicating Liquors and Fermented Malt Beverages and
Rescinding Chapter 5.22 Retail 'Class A' Intoxicating Liquor Licenses
19OR006 Revision of Section 8.36.020(o) Definition of City Forester
19OR007 Revision of Section 17.08.020(3) B-3 Industrial District
19OR008 Annexation of County Land to City (not codified)
19OR009 Revision of Section 17.04.090 Conditional Uses
19OR010 Creates Chapter 17.50 Mobile Service Transmission Tower Siting Regulation
19OR011 Revision of Section 15.15.020 to Adopt SPS Chapter 316 Electrical Code
19OR012 Annexation of Land to the City of Viroqua (Eagles Property)(not codified)
19OR013 Affirming Ordinance 321 Annexing Property to the City of Viroqua (not codified)
19OR014 Creates Chapter 17.08.020 B-5 Gateway Business Park
19OR015 Amends Chapter 3.20 Imposing a Room Tax for Tourism Promotion and
Development
20OR001 Creates Section 2.42.070 Retention of Public Records
20OR002 Creates Subsection 13.20.030(C)(3) Delayed Connection
20OR003 Amends Section 2.48 Tourism Commission

21OR001 Rescinding Chapter 9.08 Immoral Conduct 21OR002 Creating Chapter 2.50
Diversity Advisory Board
21OR003 Amending Chapter 12.12 Obstructing Streets, Sidewalks and Other Public Ways
21OR004 Rescinding Chapter 8.20 Dumpsters and Amending Chapter 10.28 Parking
21OR005 Amending Chapter 1.08 City Wards based on the 2020 census
21OR006 Rescinding Chapter 2.50 Diversity Advisory Board

22OR001 Amending Chapter 13.10 Service Line Replacement
22OR002 Amending Section 16.14.120 Land Development Improvements - Inspections
22OR003 Annexation of Land to the City of Viroqua (not codified)
22OR004 Amending Section 6.04.030 Animals Prohibited in Parks and Cemeteries
22OR005 Creating Chapter 10.50 All-terrain Vehicles and Utility Terrain Vehicles
22OR006 Amending 22OR003 -Annexation of Land to the City of Viroqua (not codified)
22OR006 (duplicate number) Creates 2.50 Housing Advisory Board
22OR007 Amending Chapter 1.08 City Wards
22OR008 Amending Chapter 1.10 Aldermanic Districts
22OR009 Amending Section 13.20.50 Sewer Service Charge System

Ordinance
Number:

23OR001	Amending 22OR006-Annexation of Land to City of Viroqua (not codified)
23OR002	Revising Chapter 8.32 Noxious Weeds
23OR003	Revising Chapter 6.09 Owning, Keeping or Harboring Chickens
23OR004	Creating Chapter 10.52 Golf Carts
23OR005	Revising Chapter 10.50 All-terrain Vehicles and Utility Terrain Vehicles
23OR006	Amending Chapter 1.08 City Wards
23OR007	Amending Chapter 1.10 Aldermanic Districts

HIGHWAYS, PUBLIC/PRIVATE PROPERTY	10.28.120
JUNKED VEHICLES	10.28.120
PARKING LOTS	10.28.100
<u>ABANDONED WELLS</u>	see WELLS
<u>ACCIDENT REPORTS</u>	10.36
<u>ADMINISTRATOR, CITY</u>	2.09
<u>AGRICULTURAL DISTRICT ZONING</u>	17.08
<u>AGRICULTURAL PRODUCTS</u>	5.32.010
<u>AIRPORT COMMISSION</u>	2.38
<u>AIRPORT</u>	
DEFINITIONS	10.40.010
HANGAR USE	10.40.030
OPERATION POLICIES	10.40.020
PARKING - PEDESTRIANS	10.40.025
PENALTY	10.40.050
<u>AIRPORT ZONING</u>	17.42
<u>ALCOHOL BEVERAGES</u>	
APPLICATION	5.20.070
FERMENTED MALT BEVERAGES	9.12
FIREARMS	5.20.120
HOURS	5.20.100
LICENSE	5.20
Denials	5.20.140
Operator	5.20.040
Required	5.20.020
OPEN CONTAINERS IN PUBLIC	9.12.010 - 9.12.030
PENALTY	5.20.160
REMOVAL IN OPEN CONTAINERS	5.20.030
RESERVE "CLASS B" LICENSEE GRANTS	5.20
SALE TO INTOXICATED PERSON	9.12.090
<u>ALDERPERSONS</u>	
COMPENSATION	2.32.010
TERMS OF OFFICE	2.36.020
<u>ALDERMANIC DISTRICTS</u>	1.10
<u>ALL-TERRAIN VEHICLE "ATV"</u>	10.50
<u>ALLEY (defined)</u>	17.16.010

AMUSEMENT DEVICE ARCADE 5.14
BUSINESS LICENSE 5.04

ANIMALS

BULL, STALLION BREEDING
 Prohibited where 9.08.010
 Violation, penalty 9.08.020
CERTAIN ANIMALS PROHIBITED 6.04.140
CRUELTY PROHIBITED, PENALTY 6.12.010
DISTURBING THE PEACE 6.04.090
DOGS 6.04
 Dangerous dogs 6.08
 Number allowed per household 6.04.020
GENERAL PROVISIONS 6.04
HORSE AND MULES 6.04.140
LICENSE FEE (COUNTY) 6.04.120
 Veterinarians and Humane Society 6.04.125
OTHER MUNICIPALITIES 6.04.105
POUND 6.04.070 , 6.04.100
PROHIBITED FROM PARKS 6.04.030
RABIES 6.04.050 , 6.04.070
RECORDS (CITY ASSESSOR) 6.04.130
RUNNING AT LARGE 6.04.010
SLAUGHTERHOUSE 5.52.050

ANGLE PARKING 10.28.140

ARCADE see AMUSEMENT DEVICE ARCADE

ASSESSMENT, SPECIAL

CURB, GUTTER 3.12
STREET GRADING, ROUGH 3.12
WASTE DISPOSAL 8.18.100
WATER, SEWER MAIN EXTENSION 3.12

ASSESSOR, (CITY TREASURER/ASSESSOR) 2.08
CONFIDENTIALITY OF INFORMATION OBTAINED 3.18
RECORD OF DOGS 6.04.130

ATTORNEY, CITY 2.10

AUTOMOBILE GARAGES 15.24

BARTENDER, TAVERN OPERATOR
BUSINESS LICENSE FEE 5.04.010

BATTERY 9.18

BICYCLES Regulation 10.42

BILLBOARDS see SIGNS

BILLIARD HALL see POOL HALL

BOARD OF APPEALS see ZONING

BOARD OF HEALTH

CHANGED TO "HEALTH OFFICER" 2.30

SWIMMING POOLS 17.04.130(K)

BOARD OF PARK COMMISSIONERS 2.20

BOARD OF REVIEW 2.24

INCOME AND EXPENSE INFORMATION OBTAINED BY ASSESSOR 3.18.010

BOND

CITATIONS 9.44.050

EXCAVATION 12.08.040

POLICE OFFICER AUTHORIZED TO ACCEPT DEPOSIT 10.08.050

INDEMNITY (FIREWORKS) 8.12.040

VIROQUA MUNICIPAL GOLF UTILITY 2.39.060

BOULEVARD FLOWER GARDENS 12.12.20

BOWLING ALLEY

BUSINESS LICENSE FEE 5.04.010

BOW AND ARROWS

PROHIBITED 2.20.010 C

BUILDING

see also FIRE DISTRICT, ZONING

CABLE TELEVISION NOTIFICATION 5.16.190(F)

CODE 15.04

DEFINITIONS 17.16.010

MANUFACTURING BUILDINGS (defined) 17.16.010

MOVING 15.04.110

PLAN COMMISSION REPORT 2.28.040(A)

TEMPORARY PERMIT 17.04.110

BUILDING INSPECTOR 17.12.010

DUTIES 15.04

ONE & TWO FAMILY DWELLINGS 15.18

SWIMMING POOL INSPECTION 17.04.130(C)

<u>BURNING, OPEN</u>	8.10	
<u>BURNING, SOLID FUEL BURNING DEVICES</u>		8.11
<u>BUSINESS DISTRICT</u>	17.08.020	
<u>BUSINESS LICENSE</u>	5.04.010	
<u>CABLE TELEVISION FRANCHISE (CATV)</u>		5.16
<u>CATS, DOGS AND OTHER ANIMALS</u>		6.04
<u>CAT LICENSES AND TAXES</u>	6.06	
<u>CEMETERY TRUST FUND</u>	3.16	
<u>CHICKENS</u>	6.09	
<u>CIGARETTE</u>		
BUSINESS LICENSE FEE	5.04.010	
SMOKING PROHIBITED	8.14	
<u>CITY HALL</u>		
SMOKING PROHIBITED	8.14	
<u>CITY FORESTER</u>	8.36	
<u>CITY TREES</u>	8.36.120	

CLERK, CITY 2.04

AMUSEMENT DEVICE ARCADE LICENSE ISSUANCE	5.14.030
APPOINTMENT	2.04.020
BUSINESS LICENSE	5.04
DEPUTY CITY CLERK	2.04
FIRE CHIEF	2.16.040(E)
FIREWORKS - indemnity	8.12.040
MOBILE HOME PARK LICENSE	5.28.040
MOVING BUILDING PERMIT ISSUANCE	15.32.020
NEW HOMES	5.28.040
OUTDOOR MARKET PERMIT ISSUANCE	5.32.010(I)
RECORDS, LEGAL CUSTODIAN	2.42.030
SALARY	2.04.040
SEWER APPLICATION	13.20.030(D)
SLAUGHTERHOUSE PERMIT ISSUANCE	5.52.020
TAXICAB LICENSE ISSUANCE AUTHORITY	5.48.040
TERMS OF OFFICE	2.04.020
TRANSIENT MERCHANT LICENSE ISSUANCE	5.44.030
WATER SERVICE PERMIT	13.040.050
WATER SERVICE PRINTED MATERIAL PROVISION	13.04.040

CODE

ADOPTION	1.01
BUILDING	15.08
COMBUSTIBLE MATERIALS	12.12.020
COMPUTATION OF TIME	1.04.070
CONSTITUTIONALITY	1.01.090
CONSTRUCTION	1.04.080
DEFINITIONS	1.04
ELECTRICAL	15.12
FIRE	15.20
MOVING BUILDINGS	15.32
ONE-FAMILY & TWO-FAMILY	15.18
ORDINANCES PASSED PRIOR TO ADOPTION	1.01.040
PENALTY, GENERAL	1.12
PLUMBING	15.16

COMMERCIAL DISTRICT 17.08.020

COMMISSION, POLICE AND FIRE 2.18

COMMISSIONER, STREET

APPROVAL OF REFUSE CONTAINERS	8.18.020
DEMOLITION MATERIAL AT LANDFILL	8.18.050
TRAFFIC-CONTROL DEVICE	
Erection, maintenance	10.12.010
Unofficial, removal	10.12.020

COMMON WALLS

ZONING, DUPLEXES 17.08.010(C)(2)(h)

COMPOSTING 8.22

COMPREHENSIVE PLANNING COMMISSION 2.26

COMPRESSION BRAKES 10.44

CONTROLLED SUBSTANCES

DRUG PARAPHERNALIA 9.41

MARIJUANA see MARIJUANA

USE ON SCHOOL GROUNDS PROHIBITED 9.20.060

COUNCIL, COMMON

see also: OFFICERS, CITY

DEFINED 1.04.010

REFERRAL TO PLAN COMMISSION 2.28.040

CROSS CONNECTION CONTROL 13.30

CURB AND GUTTER

FISCAL PROCEDURE 3.04

INSTALLATIONS - SPECIAL ASSESSMENT 3.12.020

CURFEW 9.28

DEAD OR DISEASED TREES 8.36.140

DEDICATED STREETS

GRADE 12.26

DEPOSITS see CITATION PROCEDURE 9.40.040

DEPUTY CITY CLERK 2.04

DESTRUCTION OF PROPERTY 9.10.010

DEVELOPMENT (defined) 17.16.010

MOBILE HOME DEVELOPMENTS 5.28.040 C

PLANS FOR SUBDIVISION 16.16.010

DISORDERLY CONDUCT 9.16
DISTURBING THE PEACE
 ANIMALS 6.04.090
DISCRIMINATION IN HOUSING UNLAWFUL 9.02
DOG see ANIMAL
DRUG PARAPHERNALIA (by persons under 17 years of age) 9.41
DRUNKEN DRIVING
 TRAFFIC CODE 10.04.030
DUMPSTERS 10.28.070
DUPLEX see ZONING

DWELLING (defined) 17.16.010
ELECTION 2.36
 POLLS
 Hours, notice 2.36.030
 WARDS 1.08
ELECTRICAL CODE 15.15
ELECTRONIC MESSAGES, WHEN PROHIBITED 9.46
EMERGENCY
 CABLE TELEVISION OVER-RIDE 5.16.100(c)
 DEFINED 2.12.020
 FIRE HYDRANTS 13.12.030
EMERGENCY GOVERNMENT 2.40
ENFORCEMENT - PENALTIES 10.08

ENGINEER, CITY
 SLAUGHTERHOUSE INSPECTION REPORT 5.52.020

EXCAVATION 12.08
 SEWER CONSTRUCTION 13.20.030(G)(1)

EXPLOSIVES 8.08
 GUNPOWDER PERMIT 8.08.030

FALSE STATEMENT OR RECORD

Chapter 9.48

FAMILY defined 17.16.010

FEES, LICENSES 5.04

see also: ELECTRICAL, PLUMBING, BUILDING CODES; ZONING

ALCOHOLIC BEVERAGE 5.20.060

ANIMALS 6.04.120

CABLE TELEVISION FRANCHISE 5.16.080

EXCAVATION 12.08.030

JUNK DEALER 5.24.020

MOBILE HOME PARKS 5.28.030

REQUIRED 5.04.020

SIGNS 17.40.050

SLAUGHTERHOUSE 5.52.030

TAXICAB 5.48.020

TRANSIENT MERCHANT 5.44.040

VIROQUA MUNICIPAL AIRPORT 2.38.090

FENCES 17.04.120

PERMIT 17.04.120 (j)

PROPERTY MAINTENANCE 8.28.020

FERMENTED MALT BEVERAGE

see ALCOHOL BEVERAGES

FIRE

CODE 15.20

DEFINITIONS, DEFINED 2.16.010, 15.20.030

FALSE ALARM PROHIBITED, PENALTY 9.16.020

FIRE-RESISTIVE/RETARDANT, DEFINED 15.20.030

FLAMMABLE LIQUIDS CODE ADOPTED 15.20.010

FRAME CONSTRUCTION DEFINED 15.20.030

HYDRANT

Authorized persons defined 13.12.020

Authorized uses

designated 13.12.050

police, fire departments 13.12.030

Definitions 13.12.020

Metered use required, alternatives 13.12.060

Privately owned, inspection 13.12.065

Use, notification required 13.12.040

Violation, penalty 13.12.070

OPEN BURNING PROHIBITED, EXCEPTIONS 8.10

FIRE CHIEF

BUILDING INSPECTION DUTY 15.20.140
DUTIES, POWERS 2.16.040
EQUIPMENT DUTIES 2.16.050
FIRE ESCAPES - INSPECTION 15.20.140
FIRE HYDRANT USE NOTICE 13.12.040
FIRE INSPECTOR DUTIES 2 16.070, 2.16.100
GUNPOWDER STORAGE INSPECTION 8.08.030
MUTUAL AID AGREEMENT AUTHORITY 2.16.100
OPEN BURNING PERMIT 8.10.030
POWERS, DUTIES GENERALLY 2.16.040

FIRE DEPARTMENT

2.16
CABLE TELEVISION 5.16.190 (G)
TOWNSHIP AGREEMENTS 2.16.090
COMMISSION 2.18
VOLUNTEER FIREFIGHTERS' FUND ACCOUNT 3.14

FIRE DISTRICT

BUILDING INSPECTION REQUIRED 15.20.140
CONSTRUCTION SPECIFICATIONS
 Frame construction prohibited, exception 15.20.050
 Generally 15.20.040
 Protected type 15.20.060
DANGEROUS SUBSTANCE, OBSTRUCTION, REMOVAL REQUIRED 15.20.150
DESIGNATED 15.20.020
FLAMMABLE LIQUID STORAGE REQUIREMENTS 15.20.070
OLD, DAMAGED BUILDING, REMOVAL REQUIRED 15.20.080
ROOFING, FIRE-RETARDANT REQUIRED 15.20.090
VIOLATION, PENALTY 15.20.150

FIRE ESCAPE

MAINTENANCE RESPONSIBILITY 15.20.120
REQUIRED Notice, time limit for compliance 15.20.110
 When 15.20.100
VIOLATION, PENALTY 15.20.130

FIRE HYDRANTS 13.12

FIRE, POLICE AND FIRE COMMISSION 2.18

FIREARM

9.36
ALCOHOLIC BEVERAGE RESTRICTION 5.20.120
POSSESSION, USE 9.36.010 - 9.36.020
VIOLATION 9.36.030 - 9.36.040

<u>FIREWOOD</u>	8.28.020	
<u>FIREWORKS</u>	8.12	
<u>FISCAL PROCEDURE</u>	3.04	
<u>FLAMMABLE LIQUIDS CODE</u>	15.20.010	
<u>FOUNDATION WALLS</u>	15.08.030	
<u>FUNDS, CITY</u>		
WITHDRAWAL AUTHORITY	3.04.010	
<u>GAMBLING</u>	9.04	
<u>GAMING TABLE</u>		
BUSINESS LICENSE FEE	5.04.010	
<u>GARAGE, AUTOMOBILE</u>		
ZONING	17.16, 17.04.080	
<u>GARBARGE</u>	See Solid Waste Chapter 8.18	
OUTDOOR MARKETS	5.32.010 (E)	
<u>GENERAL PENALTY</u>	1.12	
<u>GOLF</u>		
VIROQUA MUNICIPAL GOLF UTILITY	2.39	
<u>GOLF CARTS</u>	10.52	
<u>GRADE OF STREETS</u>		
SPECIAL ASSESSMENTS	3.12.030	
<u>GRASS</u>		
REGULATION OF LENGTH	8.32	
<u>GUNPOWDER</u>	8.08.030	
<u>GRADE OF STREETS</u>	12.26	
<u>HALFWAY HOUSE</u> (defined)	17.16.010	
<u>HANGAR USE</u> (AIRPORT)	10.40.030	
<u>HARASSMENT</u>	9.42	

<u>HEALTH OFFICER</u>	2.30	
SLAUGHTERHOUSE INSPECTION		5.52.100
SWIMMING POOLS	17.04.130(K)	
<u>HEAVY TRAFFIC</u>	10.20	
<u>HISTORIC PRESERVATION</u>	17.44	
<u>HOME OCCUPATION</u>	(defined)	17.16.010
<u>HORSES AND MULES</u>	see ANIMALS	
<u>HOTEL OR RESTAURANT KEEPER</u>	(fraud against)	9.37
ROOM TAX		3.20.010, 3.20.030
<u>HOUSING ADVISORY BOARD</u>	2.50	
<u>IMMORAL CONDUCT</u>	9.08	
<u>INDUSTRIAL PARK</u>	17.08.020	
<u>INTOXICATING LIQUOR</u>	see ALCOHOL BEVERAGES	
<u>JAKE BRAKES</u>	10.44	
<u>JUNK DEALER</u>	5.24	
<u>JUNK VEHICLES</u>	5.24.010	
PROPERTY MAINTENANCE		8.28
<u>LEVYING, Procedure</u>	3.12.010	
<u>LICENSE</u>	5.04	
see ALCOHOL BEVERAGES		5.20
AMUSEMENT DEVICE ARCADES		5.14.020 - 5.14.040
CATV	5.16	
DOG	6.04.010	
EXPLOSIVES	8.08.010	
JUNK DEALERS	5.24	
MOBILE HOME PARK	5.28.040	
SLAUGHTERHOUSES	5.52	
TAXICAB	5.48.010	
TRANSIENT MERCHANT		5.44.020
<u>LOITERING ON SCHOOL GROUNDS</u>	9.20	

LOT see ZONING

DEFINED 17.16.010

MANUFACTURED BUILDING (defined) 17.16.010

MANUFACTURING AND ASSEMBLING (zoning) 17.08.020

MARIJUANA 9.14

see also CONTROLLED SUBSTANCES

DRUG PARAPHERNALIA 9.41

MAYOR

see also OFFICERS, CITY

APPOINTMENTS

Airport Commission 2.38.020

Board of Park Commissioners 2.20.010

Board of Review 2.24.010

City Clerk 2.04.020

City Treasurer/Assessor 2.08.030

Deputy City Clerk 2.04.020

Health Officer 2.30.010

Plan Commission - citizen members 2.28.020

Police and Fire Commission Members 2.18.010

Sesquicentennial Committee (Alderpayers) 2.29.030

Soliciting Permit Committee 5.44.210

Taxicab Inspection Officer 5.48.140

COMPENSATION 2.32.010

ELECTION 2.36.010

FIRE DEPARTMENT - TOWNSHIP AGREEMENTS 2.16.090

TERM OF OFFICE 2.36.010

MERCHANTS, TRANSIENT 5.44

MINIBIKE, SNOWMOBILE

USE ON SCHOOL GROUNDS PROHIBITED, EXCEPTION 9.20.050

MINOR

ALCOHOL BEVERAGES

Presence in places of sale 9.12.050

Prohibitions 9.12.070

Restrictions 9.12.060

AMUSEMENT DEVICE ARCADE RESTRICTION 5.14.070

CURFEW 9.28

DELIVERY OF DRUG PARAPHERNALIA (to a minor) 9.41.050

DISORDERLY CONDUCT 9.16.040

FIREARMS 9.36.030

MOBILE HOMES: MOBILE HOME PARKS 5.28, 17.04.080(j), 17.08.010
 DEFINED 17.16.010

MOTEL
 DEFINED 17.16.010

MOTEL OPERATORS
 ROOM TAX 3.20.010, 3.20.030

MOTOR VEHICLES
 OPEN CONTAINERS (ALCOHOLIC BEVERAGES) 2.12.020, 9.12.020

MULTIPLE FAMILY RESIDENCE DISTRICT 17.18.010

MUNICIPAL COURT 2.06

MUNICIPAL POOL
 TRAFFIC 10.24.030

NEIGHBORHOOD ELECTRIC VEHICLES 10.46
NUISANCE (Public)

- ABANDONED VEHICLE 10.28.100
- ANIMALS "at large" 6.04.010
- DISTURBING THE PEACE 6.04.090
- DUTCH ELM DISEASE 8.36.010
- JUNKED VEHICLE 8.28.010
- NOXIOUS WEEDS 8.32.010
- PERMITTING, PROHIBITED 8.24.050

OBSCENE MATERIAL see PORNOGRAPHY

OBSTRUCTING STREETS AND SIDEWALKS 9.24, 12.12

OFF STREET PARKING 17.04.080(h)

OFFICERS, CITY
 COMPENSATION DESIGNATED 2.32.010
 ELECTED
 Term 2.36.020

ONE-FAMILY & TWO-FAMILY DWELLING CODE 15.18

ONE-WAY STREETS 10.26

OPEN BURNING 8.10

OUTDOOR AQUATIC FACILITY 2.29

OUTDOOR FUEL-FIRED HEATING DEVICES 8.11

OUTDOOR MARKET 5.32

EXEMPTION - TRANSIENT MERCHANT 5.44.050

PARKING 10.28

see also ZONING

ABANDONED VEHICLE 10.28.120

ANGLE/PARALLEL PARKING 10.28.140

AIRPORT 10.40.025

LIMITS GENERALLY 10.28.100

LOT, MUNICIPAL 10.28.100

MOBILE HOME PARKS 5.28.020

NIGHT, RESTRICTIONS 10.28.070

PARKING SPACE defined 17.16.010

PROHIBITED

Designated streets 10.28.070

Limited through streets 10.28.030

Sidewalks 10.28.020

SEMI-TRAILER/TRUCK 10.28.040(L)

TWO- and THREE-HOUR, DESIGNATED 10.28.015

PARKING LOTS 10.28.080

ABANDONED VEHICLES 10.28.100

BICYCLES, SKATEBOARDS, ROLLER SKATES/SKIS, PLAY VEHICLES 10.42

DEFINED 17.16.010

PARKS

BOWS, ARROWS, JAVELINS, ETC. PROHIBITED 2.20.010C

COMMISSIONERS, BOARD OF 2.20.010

DOGS OR OTHER ANIMALS PROHIBITED 6.04.03

PARKS AND RECREATION COMMITTEE

PRELIMINARY PLATS 16.16.010

PEDDLER see TRANSIENT MERCHANT

PEDESTRIANS

AIRPORT 10.40.025

PENALTY, GENERAL 1.12
 No penalty provided 1.12.010
 ANIMALS 6.04.150
 BATTERY 9.18
 DISORDERLY CONDUCT 9.16.050
 INTOXICATING LIQUORS AND FERMENTED BEVERAGES 5.20.160
 Public Places 9.12.040
 Sale to intoxicated person 9.12.090
 Underage 9.12.060 - 9.12.090
 NONPAYMENT OF FINE 1.12.020
 SQUEALING TIRES 10.38.030
 STATUTORY PENALTIES 1.12.030
 STREETS
 Bicycles, skateboards, skates/skis, play vehicles 10.42.040
 Obstruction 12.12
 Playing ball in streets 9.24.010
 12-hour parking 10.28.090
 WEEDS (failure to destroy) 8.32.030
 ZONING 17.12.040

PERMIT

AIRPORT 17.42.020 (f), 17.42.060
 BUILDING 15.04.020
 CABLE TELEVISION NOTICE 5.16.190 (f)
 ELECTRICAL 15.15
 EXPLOSIVES 8.08
 EXCAVATION 12.08.020
 FENCES 17.04.120 (j)
 FIREWORKS 8 12.002, 8.12.030
 GUNPOWDER 8.08.030
 HEATING, AIR CONDITION, VENTILATING 15.10
 JUNK DEALER 5.24.010
 MOVING BUILDINGS 15.32.010
 ONE-FAMILY & TWO-FAMILY DWELLINGS 15.18.060
 OPEN BURNING 8 10.020, 8.10.030
 OUTDOOR MARKETS 5.32.010
 PLUMBING 15.06
 POOL-BILLIARD HALL 9.32
 SIGNS 17.04.050
 SLAUGHTERHOUSE 5.52.020
 Revocation of 5.52.110
 SWIMMING POOLS 17.04.130 (c)
 TREES
 Planting, maintenance, removal 8.36.170
 UNDERGROUND WIRING 12.08.100
 WATER SERVICE CONNECTION 13 04.050, 13.04.120
 WELL OPERATION 13.32.020
 Closing wells 13.32.010

<u>PLAN COMMISSION</u>	2.28	
MATTERS TO BE CONSIDERED		2.28.040
ZONING	17.04.050	
<u>PLANNED UNIT DEVELOPMENT</u>		17.09
<u>PLATS</u>	16.16	
<u>PLAY VEHICLES</u>	(regulations)	10.42
<u>PLUMBING CODE</u>	15.06	
COUNCIL PERMISSION, SEWER SYSTEM		13.20.030
PERMIT REQUIRED	13.04.120	
<u>POLICE CHIEF</u>		
EMERGENCY (defined)	2.12.020	
FIRE HYDRANT USE NOTICE	13.12.040	
POLICY MANUAL	2.11.030	
SECOND IN COMMAND	2.11.030	
STOPPING, PARKING, POLICE CHIEF TO DESIGNATE		10 24.020, 10.28.060
<u>POLICE AND FIRE COMMISSION</u>		2.18
<u>POLICE DEPARTMENT</u>		2.11
<u>POLICE OFFICER</u>		
CITATIONS	9.44.030	
RESISTING, INTERFERENCE	9.06	
TRAFFIC/VEHICLE PENALTIES (Receipts - Records)		10.08
<u>POLLING PLACE</u>		2.36.030
<u>POOL AND BILLIARD HALL</u>		9.32
BUSINESS LICENSE FEE		5.04.010
<u>PORNOGRAPHY</u>		9.40
<u>PRIVATE WELLS</u>		see WELLS
<u>PROFESSIONAL OFFICE</u>		defined 17.16.010

PROPERTY

DEFINED 1.04.010
DESTRUCTION 9.10.010
MAINTENANCE 8.28.020
PENALTY 8.28.030
SNOW REMOVAL 12.16
WEEDS 8.32.020

PUBLIC NUISANCE see Nuisance, Public

PUBLIC PARK SPACE

ARROWS, JAVELINS, ETC. PROHIBITED 2.20.010 C
MOBIL HOME PARK 5.28.040 (C)

PUBLIC PEACE, MORALS, WELFARE 9.0

PUBLIC RECORDS see RECORDS 2.42

PUBLIC TREE CARE 8.36

PUBLIC WAY defined 17.16.010

PUBLIC WORK Without Bidding Chapter 12.28

PUBLIC WORKS COMMITTEE

GRADE OF DEDICATED STREETS 12.26.010
VIROQUA MUNICIPAL GOLF UTILITY 2.39.070

RABIES 6.04

RACES ON CITY STREETS 10.48

RECORDS 2.42

BUILDING AND CONSTRUCTION 15.04
CABLE TELEVISION 5.16.100(d)
CEMETERY TRUST FUND 3.16.020
FIRE DEPARTMENT 2.16.040(H)
PLAN COMMISSION 2.28.070
SEWER 13.20.020
VEHICLE/TRAFFIC PENALTIES (receipts) 10.08.040
VIROQUA MUNICIPAL GOLF UTILITY 2.39.050

REFUSE see Solid Waste Chapter 8.18

RESISTING OFFICER see POLICE OFFICER

RESTAURANT KEEPER (fraud) see HOTEL

ROOM TAX 3.20

REVENUE AND FINANCE Title 3
CEMETERY TRUST FUND 3.16
CONFIDENTIALITY OF INFORMATION 3.18
FISCAL PROCEDURE 3.04
SPECIAL ASSESSMENT 3.12

REVIEW, BOARD OF 2.24

ROLLER SKATES, ROLLER SKIS, REGULATION 10.42

SALARIES, OFFICER'S 2.32
AIRPORT COMMISSION 2.38.040
BOARD OF REVIEW 2.24.020
PLAN COMMISSION 2.28.030

SALVAGE YARD 5.04.010

SCHOOL BUS see TRAFFIC
WARNING LIGHTS 10.12.040

SCHOOL DROPOUT 9.22

SCHOOL GROUNDS
CONTROLLED SUBSTANCES 9.20.060
LOITERING 9.20
MINIBIKES, SNOWMOBILES 9.20.050
PENALTY 9.20.070

SEMI-TRAILER/TRUCK PARKING 10.28.040(L)

SEPTIC TANKS PROHIBITED 12.20.030(c)(1)

SETBACK see ZONING
DEFINED 17.16.010

SEWER
see also SUBDIVISION, WATER, SEWER
SEWER USE AND USER CHARGES 13.20
City as customer, charge 13.20.050

SEXUAL OFFENSES see PORNOGRAPHY

SHOPLIFTING 9.38

SIDEWALK see STREETS AND SIDEWALKS

SIGN 17.40

see also ZONING

Appeals and Variances 17.40.070
Definitions 17.40.020
Design, Construction, and Maintenance 17.40.040
Design Review 17.40.080
Electronic Variable Message Signs 17.40.170
Exempt Signs 17.40.150
Historic Signs 17.40.090
Nonconforming Signs 17.40.050
Permits and Fees 17.40.030
Prohibited Signs 17.40.160
Signs Allowed on Private Property 17.40.120
Signs In the Public Right of Way 17.40.140
Violations and Remedies 17.40.060

SLAUGHTERHOUSE 5.52

see also ZONING

SMOKING, REGULATED 8.14

SNOW REMOVAL 12.16

SODA WATER BUSINESS LICENSE FEE 5.04.010

SOLICITOR see TRANSIENT MERCHANT

SOLID FUEL BURNING DEVICES 8.11

SOLID WASTE 8.18
Solid Waste and recycling surcharge 8.18.030 C

SPECIAL ASSESSMENTS 3.12

SPEED LIMIT see TRAFFIC
RESTRICTIONS 10.16

SQUEALING TIRES see TRAFFIC 10.38

STATE FLAMMABLE LIQUIDS CODE 15.20.010

STOP SIGNS
DESCRIBED LOCATIONS 10.24.010

STREETS AND SIDEWALKS

see also ASSESSMENT, SPECIAL; EXCAVATION

OBSTRUCTION 12.12

SIDEWALK

Curb, gutter, construction authority 3.04.020
Defined 1.04.010
Expense, assessment 12.04.060
Parking prohibited 10.28.020
Regulation of bicycles, skateboards, roller-skates/skis, & play vehicles 10.42.030

SNOW REMOVAL 12.16

STREET

see also SUBDIVISION 16.12
Cable Television Limitations 5.16.090 (c)
Defined 1.04.010
Fire hydrants 13.12.050
Grade 12.26
House numbering 12.24
Major street - width 16.12.040
Obstruction 12.12
One-way 10.26
Parking 10.28
Plan commission 2.28.040
(c)
Playing ball in, prohibited
9.24.010
Special assessment 3.12.030
Trees (prohibited acts) 12.20.010
Weeds 8.32.010 - 8.32.020

SUBDIVISION S 16.12

TRAFFIC REGULATIONS see TRAFFIC

STREET COMMISSIONER

EXCAVATION PERMIT 12.08.020
Liability Insurance required 12.08.050

STRUCTURE defined 17.16.010

SUBDIVISIONS Title 16

see also SEWER, WATER

SUPERINTENDENT OF STREETS

EXCAVATION NOTIFICATION DUTY 12.08.070

SWIMMING POOLS 17.04.130

TAX

CITY OBLIGATED 2.08.050
ROOM TAX 3.20

SIDEWALKLK REPLACEMENT 12.04.060

TAXICAB 5.48

TELEVISION CABLE TELEVISION FRANCHISE 5.16

TERMS OF OFFICE

ALDERPERSONS 2.36.020
AIRPORT COMMISSION 2.38
CHIEF OF POLICE 2.18.020
CITY CLERK-TREASURER 2.04.020
CITY ASSESSOR 2.08.010
CITY ATTORNEY 2.10.010
FIRE CHIEF 2.18.020
MAYOR 2.36.020
VIROQUA MUNICIPAL GOLF UTILITY COMMISSIONER 2.39.030

THEFT 9.10.020
SHOPLIFTING 9.38

THROUGH HIGHWAYS 10.24

TOURISM COMMISSION 2.48

TOURISM PROMOTION & DEVELOPMENT 3.20

TRAFFIC

ACCIDENT REPORTS 10.36.010
AIRPORT 10.40
BICYCLES, SKATEBOARDS, ROLLER SKATES/SKIS, PLAY VEHICLES 10.42
STATE STATUTES ADOPTED 10.04.020
CONTROL DEVICES 10.12
ENFORCEMENT 10.08
MUNICIPAL POOL 10.24.030
ONE-WAY STREETS 10.26
PARKING see PARKING 10.28
PENALTIES 10.08
SCHOOL BUS WARNING LIGHTS 10.12.040
SPEED LIMIT 10.16
SQUEALING TIRES 10.38.010
THROUGH HIGHWAYS DESIGNATED 10.24.010

TRANSIENT MERCHANT 5.44

TREASURER-ASSESSOR 2.08

CEMETERY FUND 3.16.020
EXCAVATION PERMIT FEE 12.08.030
MOBILE HOME PARKS - NEW HOMES 5.28.050
RECORD OF DOGS 6.04.130
WATER AND SEWER MAIN EXTENSION - COST ADVANCE 3.12.060
WATER SERVICE VIOLATION FEE 13.04.080

TREES AND SHRUBS 8.36
BOARD OF PARKS COMMISSION 2.20
REMOVING TREES IN RIGHT OF WAY 12.20.010
REPORT TO COUNCIL 2.20.040

TRESPASSING 9.26

TRUANCY 9.22

UNDERAGE (Alcoholic Beverages) 9.12.050 - 9.12.070

UNDERGROUND WIRING 12.08.090, 12 08.100, 12.08.110

UNIFORM DWELLING CODE 15.18

UNSAFE BUILDINGS 15.04.090

USE defined 17.16.010

UTILITY

DEFINED 17.16.010

USER FEES - PENALTY

Airport 2.38.090

VIROQUA MUNICIPAL GOLF UTILITY 2.39

UTILITY TERRAIN VEHICLE "UTV" 10.50

VARIANCE (defined) 17.16.010

VEHICLE see JUNK VEHICLE, PARKING, TRAFFIC
OBSTRUCTING STREETS AND SIDEWALKS 12.12

VENDING MACHINE

BUSINESS LICENSE FEE 5.04.010

VIROQUA MUNICIPAL AIRPORT

AIRPORT COMMISSION MANAGEMENT 2.38.060

USER FEES - PENALTY 2.38.090

VIROQUA MUNICIPAL GOLF UTILITY 2.39.010

VISION CLEARANCE (defined) 17.16.010

WARD Wards, aldermanic districts 1.08, 1.10

WATER

see also SUBDIVISION, WATER, SEWER

FIRE HYDRANTS 13.12

METER 13.04.070, 13 04.110, 13.12.060

PRIVATE WELLS 13.32

RATES 13.04.060

REPAIRS WITHIN THE CITY 13.04.090

SERVICE OUTSIDE CITY Generally 13.08

SERVICE WITHIN CITY Generally 13.04
SPECIAL ASSESSMENTS 3.12

WATER, SEWER

CROSS CONNECTIONS 13.30
MAIN EXTENSION 3.12
Metered water 13.20.050
PRIVATE WELLS 13.32

WEAPON see FIREARM

WEEDS 8.32

WELLS 13.32

WORTHLESS CHECKS 9.10.030

YARD defined 17.16.010

ZONING 17

ACCESS TO STREET 17.04.080
ADMINISTRATION 17.12
ADVERTISING IN BUSINESS AREAS 17.04.040
AGRICULTURAL TRANSITION DISTRICT 17 08.010 A1
AIRPORT 17.42.030
AIRPORT HEIGHT LIMITATIONS 17.42.050
BOARD OF APPEALS 17.12.3030, 17 42.080, 15.18.090
BUILDING PERMIT
Moratorium 17.04.110
BUSINESS DISTRICT 17 08.020 B1
CENTRAL BUSINESS DISTRICT 17 08.020 B1
COMMERCIAL DISTRICT 17 08.020 B2
CONDITIONAL USES 17.04.090
CONSERVANCY DISTRICT 17 08.010 C1
DEFINITIONS 17.16.010
DISTRICTS 17.08
DUPLEX, COMMON WALL 17.08.010 C 2 h
ENFORCEMENT 17.12.040
EXCEPTIONS 17.04.080
EXPLOSIVES 8 08.010, 8.08.020
"FAMILY" DEFINED 17.16.010
FENCES 17.04.120
GARAGE 17.16, 17.04.080
GATEWAY BUSINESS PARK 17 08.020 B5
GENERAL PROVISIONS FOR ALL DISTRICTS 17.04.080
HISTORIC PRESERVATION 17.44
INDUSTRIAL DISTRICT 17 08.020 B3
INDUSTRIAL PARK DISTRICT 17 08.020 B4
LIABILITY 17.04.070
LIBRARY 17.080.020 (A2 AND B2)

MANUFACTURING AND ASSEMBLING 17.08.020
MOBILE HOME PARK DISTRICT 17 08.010 R3
MOBILE HOMES GENERALLY 17.04.080 J
MORATORIUM, OF BUILDING PERMITS 17.04.110
MULTIPLE FAMILY DISTRICT 17 08.010 R2
NON-CONFORMING PREMISES 17.04.100
OFF-Street PARKING 17.04.080 H
PARKING 17.04.080 H
PLAN COMMISSION 17.04.090
SETBACK
 Exceptions 17.04.080 F
SIGNS 17.04.080 I
SINGLE AND TWO-FAMILY DISTRICT 17 08.010 R1
SLAUGHTERHOUSE 5.52.020
SWIMMING POOLS 17.04.130
TITLE 17.04.010
TWO-FAMILY DISTRICT 17 08.010 R1
"VARIANCES" DEFINED 17.16.010
VETERANS MEMORIALS 17.08.020 A.2.W
VIOLATIONS AND PENALTY 17.12.040